

Publications by the Department of Art History at the University of Helsinki, no. XVIII
in Co-operation with the Finnish Institute at Athens

Jari Pakkanen

The Temple of Athena Alea at Tegea

A Reconstruction of the Peristyle Column

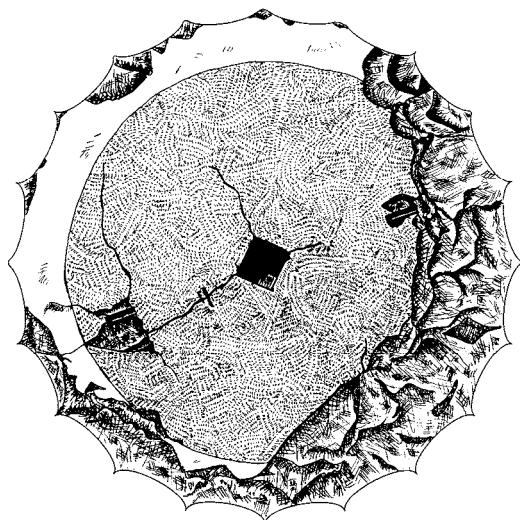

The Temple of Athena Alea at Tegea
A Reconstruction of the Peristyle Column

Publications by
the Department of Art History at the University of Helsinki, no. XVIII
in Co-operation with the Finnish Institute at Athens

Jari Pakkanen

The Temple of Athena Alea at Tegea

A Reconstruction of the Peristyle Column

Helsinki 1998

© Jari Pakkanen, the Department of Art History at the University of Helsinki, and the Foundation of the Finnish Institute at Athens 1998

ISSN 0357-4164

ISBN 951-45-8407-4

Cover illustration: Tegea, temple of Athena Alea; bottom surface of a peristyle column drum (block 115). Drawing by Petra Pakkanen.

Available from: The Department of Art History
P.O. Box 3, FIN-00014 University of Helsinki, Finland

Contents

Preface	i
Abbreviations	iii
List of Illustrations	v
I. Introduction	1
1. Preliminary Catalogue of Building Blocks	3
2. Earlier Investigations	4
A. Archaeology	6
B. Other Previous Studies on the Temple	7
3. The Classical Temple	8
II. Column Drums	11
1. Documentation	14
A. Zone Sheets	14
B. The Method of Taking Measurements and Drawing	17
2. Identifying the Drums Numbered by Dugas and Clemmensen	20
3. Drum Features	22
A. The Lowest Drums	24
B. The Top Drums	26
C. Are All the <i>E</i> Drums from the Peristyle?	27
4. Arris Repairs	29
III. Capitals	31
IV. Horizontal Curvature	41
1. Foundations	42
2. Entablature	45
V. Height of the Column	49
1. The Dugas & Clemmensen Reconstruction of the Column Height	49
2. Determining the Height of the Column	50
A. Classical Statistical Confidence Interval of the Shaft Height	52
B. Bootstrap- <i>t</i> Method for Constructing Confidence Interval	53
C. Monte Carlo Method for Testing Bootstrap Confidence Intervals	54
D. Monte Carlo Test for Confidence Intervals and Non-random Data	55
E. Probability of Matching Column Drums at Tegea	57
F. Matching Drums	57
G. Height of the Column Shaft	59
3. The Shaft Profile	62
A. Possible Combinations of the Column Drums	62
B. Shaft Profiles and Maximum Entasis	62
4. Shaft Design	67
A. Foot Unit	67
B. Drum Heights	68
C. Entasis Design	68
5. Column Proportions	72
VI. Conclusions	75
Sources and Literature	77
Glossary of Architectural Terms	83
Appendix A: Column Drums	
Appendix B: Capitals	
Appendix C: Architrave and Frieze Blocks	
Appendix D: Capital and Column Measurements Used in Architectural Comparison	
Appendix E: Computer Programs	
Index	191

Preface

My involvement with Tegea began in 1993, the fourth year of the five year Norwegian excavation project at the sanctuary of Athena Alea; this publication has evolved directly from the documentation project of the building blocks at the site. I owe my greatest gratitude to Professor Erik Østby, the director of the excavations and the Norwegian Institute at Athens, for his continuous support and guidance. The Greek collaborators of the excavation project are Dr. Th. G. Spyropoulos, the ephor of antiquities of Arcadia and Laconia, and Dr. A. Delivorrias, the director of the Benaki Museum at Athens.

The slightly unusual appearance of the volume for a book on ancient architecture is due to multiple aims I am trying to attain. Combining methodological questions with the study of preserved blocks is typical of large part of the publication. For example, how can computer programming and statistics be used to obtain more information from architectural and archaeological data? The results are often less accurate than previously published dimensions of the building. In many cases, millimetre exact information of the Greek buildings cannot be achieved, and computerised analysis provides a method for finding the most probable range for the dimension in question. Both the proportional analysis of the buildings and the reconstruction drawings, as well as computer models, are dependent on accurate data; in studies of proportional relationships especially, unwarranted measurement accuracy may lead to incorrect conclusions.

One of the objectives of this study is to make publicly accessible a more thorough account of the computer programs and statistics used in the five papers of my dissertation; for example, no program listings could be published in the papers. In fact, the initiative for the publication came from Seppo Mustonen, Professor of Statistics at the University of Helsinki, who at the time was a referee of my dissertation. I wish to thank him sincerely for his suggestion and all his comments on my work during the past five years; these comments have occasionally resulted in months more work. I am very grateful to the Department of Art History at the University of Helsinki for accepting this book into the publication series and to the Foundation of the Finnish Institute at Athens for its co-operation; from the department I am especially indebted to Professors Riitta Nikula and Jukka Ervamaa for their encouragement. The original basis of this book is my licentiate thesis submitted to the department in 1995.

During the final phase of writing, the comments of Richard Anderson, architect of the Athenian Agora, Dr. Petra Pakkanen, and Dr. Jonathan Tomlinson have been of especial value. The last mentioned has also revised the language of the text. The following persons have also read either my licentiate thesis or various stages of the manuscript of this book, and their comments have been more than welcome: Docent Anja Kervanto-Nevanlinna, Dr. Manolis Korres, Prof. Seppo Mustonen, Prof. Riitta Nikula, Prof. Erik Østby, Prof. Ahti Pakkanen, Docent Leena Pietilä-Castrén, and Dr. Nicholas Rodgers.

To all the friends I have made during the years at Tegea I am very grateful; they are far too numerous to be listed here. The following persons have participated in the documentation of the blocks used in the publication: Anne-Claire Chauveau, Øystein Ekroll, Anne Hooton, Christina M. Joslin, Marianne Knutsen, Tara McClenahan, Petra Pakkanen, Thomas Pfauth, and Tuula Pöyhiä; without their help this study would not have been possible.

The Finnish Institute at Athens, and its good co-operation with the neighbouring Scandinavian archaeological institutes and the Nordic Library, has been a of crucial importance for this study. I wish to thank the following the past directors of the Finnish Institute for having especially contributed to this book: General Director Henrik Lilius for bringing me in contact with Erik Østby, and Prof. Jaakko Frösén for his part in the publication process. I am greatly indebted to Prof. Olli Salomies and Maria Martzoukou for the current favourable working environment at the Finnish Institute.

The study has greatly benefited from various discussions on the sanctuary of Athena Alea with my colleagues; in addition to those persons named above, my thanks are particularly due to Michael Djordjevitch, David Johnson, Dr. Gullög Nordquist, Prof. Olga Palagia, Prof. Richard A. Tomlinson, Prof. Mary Voyatzis, and Dr. Ian Whitbread.

On practical matters concerning the publication Eva Kanerva, Stavros Malagardis, and Harri Markkula have been of invaluable help.

The research presented in the publication has been funded mostly by the Academy of Finland and, for the past one-and-a-half years, by my employer, the Foundation of the Finnish Institute at Athens. For my early involvement with the Tegea excavation project I received financial aid from the Centre for International Mobility, the Friends of the Finnish Institute at Athens, and the Kari Kairamo Memorial Fund.

I am very grateful to my parents, Eila and Ahti, my brother and sister, Juha and Laura, and their families, for their continuous support. With love I dedicate this study to my wife Petra.

Athens, December 1998
Jari Pakkanen

All the programs presented in the study whose copyright is owned by the author are freely available on request.

The Finnish Institute at Athens
Zitrou 16, GR-11742 Athens, Greece
e-mail: jpakkane@compulink.gr

Abbreviations

AbH	Abacus height
AbW	Abacus width
AnnH	Annulet height
CapH	Capital height
ColH	Column height
Diam _A	Diameter of the capital neck at the arrises
Diam _L	Lower diameter of a drum or column between the flutes
Diam _{LA}	Lower diameter of a drum or column between the arrises
Diam _U	Upper diameter of a drum or column between the flutes
Diam _{UA}	Upper diameter of a drum or column between the arrises
DrH	Drum height
EchH	Echinus height
Ent _{max}	Maximum entasis
FIW _L	Flute width of a drum or column at the bottom
FIW _U	Flute width of a drum or column at the top
H	Height
L	Length
t.	Temple
TrachH	Trachelion height
W	Width

For the terminology, see the Glossary on p. 83.

List of Illustrations

- Fig. 1. Histogram of possible column height combinations. Based on measurements by M. Clemmensen, Dugas *et al.* 1924, 131–133. (J. P.)
- Fig. 2. Ground plan of the temple of Athena Alea. Scale 1:250 (J. P.)
- Fig. 3. The east façade of the temple of Athena Alea. Scale 1:150. (J. P.)
- Fig. 4. Idealised column shaft of the exterior column of the temple of Athena Alea at Tegea. Entasis ignored. (J. P.)
- Fig. 5. Zone sheet for a column drum. Original size A4, no longer to scale. (J. P.)
- Fig. 6. Measuring the diameter of block 3 with the large callipers. (Photograph by P. Ekström, 1994.)
- Fig. 7a. The zone sheet for block 454. (A.-C. Chauveau and J. P.)
- Fig. 7b. Measuring the flute width of block 9 with a special instrument. (Photograph by T. McClenahan, 1998.)
- Fig. 8. Plan of column drums and drum fragments with block numbers. Dugas' and Clemmensen's numbers marked with a prefix D. (J. P.)
- Fig. 9. Arris repair on block 809. (Photograph by J. P., 1995.)
- Fig. 10. Reconstruction of a largely preserved arris repair. Outer surfaces of the repair pieces hypothetical (finished when in place). Dimensions in millimetres. (J. P.)
- Fig. 11. Plan of capitals and capital fragments with block numbers. (J. P.)
- Fig. 12. Capital profile, block 562. Scale 1:2. Dimensions in millimetres. (J. P.)
- Fig. 13. Peristyle capital, block 501. (M. Clemmensen, Dugas *et al.* 1924, pl. 35.)
- Fig. 14. Peristyle capital, block 562. (M. Clemmensen, Dugas *et al.* 1924, pl. 36.)
- Fig. 15. Horizontal curvature of the foundations on the south long side. Values on the x and z axes are the x and z co-ordinates of the general co-ordinate system of the sanctuary. Solid line: new measurements; dotted line: Clemmensen's measurements. Scale on x axis 1:400 and on z axis 1:2. (J. P.)

Fig. 16. Horizontal curvature of the foundations on the west short side. Values on the y and z axes are the y and z co-ordinates of the general co-ordinate system of the sanctuary. Solid line: new measurements; dotted line: Clemmensen's measurements. Scale on y axis 1:400 and on z axis 1:2. (J. P.)

Fig. 17. Plan of architrave and frieze blocks diagnostic of horizontal curvature with block numbers. (J. P.)

Fig. 18. Exaggerated horizontal curvature of the west façade of the temple of Athena Alea. (J. P.)

Fig. 19. Polygonal, hypotenuse and true height of a column shaft. (J. P.)

Fig. 20. Histogram of the height of the preserved column drums. $N = 60$. (J. P.)

Fig. 21. Upper surface of block 35. Scale 1:10. (Drawing by P. Pakkanen from a field drawing by J. P.)

Fig. 22. Upper surface of block 115. Scale 1:10. (Drawing by P. Pakkanen.)

Fig. 23. Histogram of possible shaft height combinations: $N = 27,516$. Based on new measurements. (J. P.)

Fig. 24. Example of accepted shaft profile. (J. P.)

Fig. 25. Example of rejected shaft profile. (J. P.)

Fig. 26. Shaft profile with exaggerated x axis (left); reconstruction of the peristyle column (right; scale 1:50). (J. P.)

Fig. 27. Hypothetical design drawing of the shaft profile. Dimensions in dactyls. (J. P.)

Fig. 28. Hypothetical design drawing of the shaft profile (large circle). (J. P.)

Fig. 29. Technical terms for building façade. (J. P.)

I. Introduction

Presented here is a restudy of the peristyle columns of the fourth-century BC temple of Athena Alea at Tegea in the Peloponnese.¹ The need for the study is not perhaps immediately apparent as the architecture of the temple was published in 1924 by Ch. Dugas and M. Clemmensen in the excellent monograph *Le sanctuaire d'Aléa Athéna à Tégée au IV^e siècle* where it is clearly stated that the reconstruction of the column is absolutely exact.² Recent studies have mainly concentrated on the arrangement of the cella and the Corinthian capital,³ and when the exterior reconstruction has been discussed, almost only the voice of the original publication has been echoed.⁴ It is actually this certainty which, in 1994, caused me to start to wonder, how it is possible to give a millimetre exact reconstruction of the column height when there are no column drums *in situ* and there is consid-

¹ A brief, preliminary account of this study is published in Pakkanen 1996a, 695–702.

² “Elles nous font aussi connaître le diamètre inférieur des colonnes et, grâce aux tambours que nous possédons (voir l’appendice II), il est possible de présenter de la colonne une reconstitution absolument exacte.” Dugas *et al.* 1924, 18.

³ See pp. 7–8.

⁴ E.g., most recently, “Enough material remains to reconstruct the exterior of the temple with complete confidence” (Norman 1984, 170) and “more architectural blocks from it [the Classical temple] are coming to light in the excavation, but they will hardly require revision of those reconstructions which were offered in the original publication of 1924, and which have been corrected on minor points in recent studies” (Østby 1994, 53). The only exception I have come across is in a footnote in Norman’s article where she cites Clemmensen’s own doubts (Clemmensen 1925, 11–12) over the column height reconstruction (Norman 1984, 180 n. 69); see p. 50.

2 The Temple of Athena Alea at Tegea

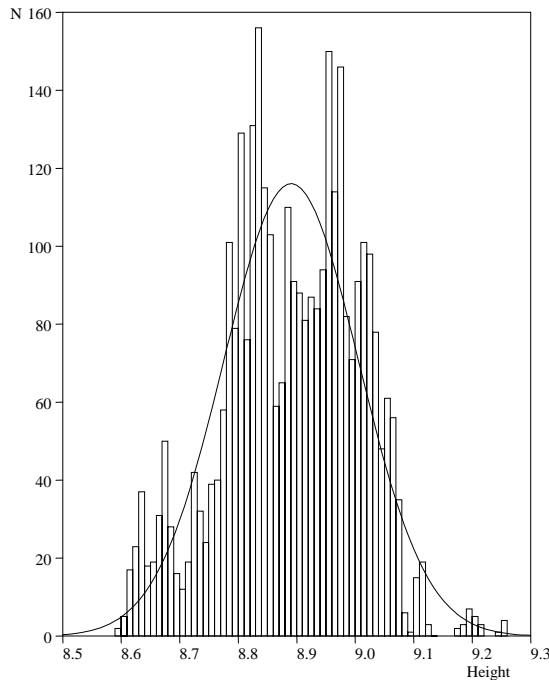

Fig. 1. Histogram of possible column height combinations: $N = 3,361$, measurement tolerance ± 3 mm. Based on measurements by M. Clemmensen; Dugas . *et al* 1924, 131-133.

erable variation in the height of the drums.⁵

In order to investigate the possible ways of combining the column drums I wrote a computer program:⁶ as input data it takes the number of the block, upper and lower diameters of the drum between the flutes, and the height of the drum. The arrises of most of the blocks are largely broken, thus matching the drums on the basis of diameter between the arrises and flute width was not possible—only combining the drums according to the diameters at the bottoms of the flutes was tested. All the published measurements are in millimetres, but usually such precision cannot be attained in measuring the column drums of the temple due to broken surfaces, weathering of the blocks and slight irregularities in the shape of the drums. I chose to consider this problem by giving as a parameter the amount of difference allowed in finding two fitting blocks. For example, tolerance of 3 mm defines a 6 mm range for the drum diameter—in this case I would be expecting a possible error of ± 3 mm in Clemmensen's measurements.⁷ If the upper diameter

⁵ Clemmensen measured the column drums at the site and published the measurements of 47 drums (Dugas *et al.* 1924, app. II 131–133): the greatest variation is found in level *C* (third drum from the bottom) where the shortest drum is 1.321 m and the tallest 1.675 m, giving a difference of ca. 0.35 m. In the appendix Clemmensen is reported as the sole author of the table.

⁶ On the program used to produce shaft combinations, see also p. 62 and App. E, p. E2.

⁷ It is very hard to find one correct figure for tolerance to be given as the parameter to the program. In the first place, the expected accuracy of Clemmensen's measurements should be considered. It is apparent from his brilliant drawings in the publication (Dugas *et al.* 1924, pls. 1–81) that his work is very accurate. But giving too much respect to the published figures' accuracy leads to loss of information: possible combinations would then be excluded. Therefore, the suggested tolerance of 3 mm is a compromise, and should be regarded only as an initial proposition necessary at this stage of the study.

range of the lower block and the lower diameter range of the upper block overlap, the pair is accepted as possibly matching.

Figure 1 displays the column shaft heights of the possible combinations as a histogram: with the tolerance set at 3 mm there are 3,361 ways to combine the column drums. The minimum height of the column is 8.60 m and the maximum height 9.26 m. The mean, 8.89 m, is close to the shaft height suggested by Dugas and Clemmensen, 8.885 m. But examination of the histogram shows that the centre classes are surprisingly vacant, and there are two clear clusters which do not coincide with the average height: the first at 8.80–8.85 m, and the second at 8.95–8.98 m. Clearly, therefore, the matter needs to be studied further.

In Chapters II–IV I will discuss the documentation and the architectural material, and Chapter V presents the method for reconstructing the height of the column.

1. Preliminary Catalogue of Building Blocks

This study on the peristyle columns is closely connected with the project of cataloguing building blocks in the sanctuary. The project has two objects: firstly, it will provide a basis for further research on the temple, and secondly, it is the first step toward a plan to rearrange the blocks at the site and for any future projects of conservation or restoration.

The catalogue was started by E. Østby in 1990, the opening season of the five year Norwegian excavation project led by him.⁸ It included forty-nine blocks which had been lifted on top of the temple foundations during the previous excavations and fifty blocks lying north and north-east of the foundations. The catalogue does not include the blocks remaining *in situ*: these are the foundation and stylobate blocks for the columns of the Archaic cella and the foundation and the few euthynteria blocks of the Classical temple. These have been quite well documented during previous research and could therefore be given a lower priority.⁹ The entry for each block consisted, at this stage, of a description of the block with its basic dimensions.

In the autumn of 1992 E. Østby requested me to continue the catalogue in 1993. A complete preliminary catalogue of the building blocks was set as the goal for the season: it would include a short description of the block, the basic measurements needed for identifying the block, and its position in the general coordinate system of the sanctuary. The positions of the blocks were plotted using a theodolite with an electronic distance meter.¹⁰ The catalogue currently includes

⁸ On the excavations, see pp. 6–7.

⁹ A drawing of the Archaic foundations was made by D. I. Sonerud in 1995, and a new drawing of the Classical foundations is being prepared by the author.

¹⁰ I was greatly assisted by T. Pfauth in plotting the blocks' positions. C. M. Joslin and M. Knutsen also participated in taking the measurements. With the measuring and identification of the blocks I

820 blocks, almost all from the Classical temple, but some from other buildings, such as the few Byzantine building fragments (double columns and a capital) and a starting line block from the stadium of Tegea. This is not *in situ*, but it supports the hypothesis that the stadium was in the immediate vicinity of the sanctuary.¹¹

The 99 blocks initially studied by E. Østby established the order in which the remaining blocks were documented: the first block lies on the north-west corner of the foundations, and following this, in a clockwise direction, are the blocks on the foundations. Next, starting west of the north ramp and again moving clockwise, the blocks around the foundations were listed. There are two major exceptions to this rule: the large deposit at the south-east angle of the sanctuary and the deposit of smaller blocks at the eastern part of the sanctuary was both initially omitted and catalogued later, after the other blocks. The final task of the 1993 season was the cataloguing of the new blocks found in 1990–93.

A supplement to the catalogue is a plan of the sanctuary; the co-ordinate points with the block identification number are automatically plotted on top of the plan which was redrawn for computer. The greatest advantage of the electronic plan is versatility: plans at different scales can easily be printed, and different prints of certain types of blocks can also be made.¹² The current site plan with all the blocks is at a scale of 1:250.

During the 1994 and 1995 seasons most of the field work was connected with aspects presented in this study: the column drums, cella wall blocks, capitals, architraves, and frieze blocks were subjected to more extensive examination.¹³ In 1998 some of the drum data were rechecked and the flute widths of all the drums remeasured. The new measurements and observations have also been included in the preliminary catalogue.

2. Earlier Investigations

The sanctuary was first identified in the village of Piali (now Alea) by E. Dodwell in 1806 from the visible architectural remains of the temple:

“On the 7th of March, we visited the ruins of Tegea ... Some hundred yards from this church [Palαιο Episkopi], is the village of Piali, and a few remains of the great temple of Minerva Alea, built by Skopas of Paros; the original temple, built by Aleus, son of Aphi-

was helped by Ø. Ekroll whose main task has been to participate in the project of planning a more convenient arrangement of the building blocks at the site.

¹¹ For a discussion of the stadium location, see Voyatzis 1990, 14–15 and Østby 1994, 53–54.

¹² See Figs. 8, 11, and 17 for plans produced by automatic plotting.

¹³ The persons who have also participated in the documentation are as follows: column drums: A.-C. Chauveau, Ø. Ekroll, and T. Pfauth in 1994, P. Pakkanen in 1995; cella wall blocks: Ø. Ekroll in 1994; architraves and frieze blocks: P. Pakkanen in 1995 and 1996; study and new drawings of various blocks: T. Pöyhiä in 1996; column drum rechecks: A. Hooton and T. McClanahan in 1998. Without their help the building block study would not have been possible.

das, having been burnt in the ninety-sixth Olympiad. It was composed of the three orders of Grecian architecture. Above the Doric was the Corinthian, surmounted by the Ionic. I found fragments of the different orders. There are several large masses of Doric columns of white marble, but the greatest part is buried. I was not able to take exact dimensions; but those of the Doric order did not appear to be much inferior in size to those of the Parthenon.

Their size may probably have contributed to their preservation, as they were too heavy to be removed. The two other orders were no doubt much smaller, and have been carried to Tripolitza, as very few fragments of them remain.

We are informed by Pausanias that this temple was one of the largest and most ornamented in the Peloponnesos. The Calydonian hunt was represented on its front tympanon, while the posticum exhibited the battle of Telephos and Achilles in the plain of Kaikos.”¹⁴

Dodwell is quite liberal in reading Pausanias’ description of the temple,¹⁵ but the passage has been a difficult one for modern scholars as well: for more than a century it has been debated whether to keep Pausanias’ original ἐκτός in connection with the Ionic columns,¹⁶ or to emend it to ἐντός.¹⁷ I have recently argued that the original reading should be kept and that instead of reconstructing the temple interior with Ionic half-columns on top of the Corinthian ones,¹⁸ a podium could be placed below the Corinthian order and the Ionic order omitted.¹⁹ Dodwell’s observation on the size of the Doric columns is also slightly erroneous: the difference in size between the exterior orders of the Parthenon and the temple of Athena Alea is substantial, but even today the drums at Tegea are an impressive sight.²⁰

¹⁴ Dodwell 1819, 418–419.

¹⁵ Paus. 8.45.4–7. Pausanias explicitly states that the temple was the largest in the Peloponnese (8.45.5), even though there are several larger ones (see Østby *et al.* 1994, 89 n. 2).

¹⁶ ὁ μὲν δὴ πρῶτος ἐστὶν αὐτῷ κόσμος τῶν κίωνων Δωρίος, ὁ δὲ ἐπὶ τούτῳ Κορινθίος· ἐστήκασιν δὲ καὶ ἐκτὸς τοῦ ναοῦ κίονες ἐργασίας τῆς Ἰώνων. Paus. 8.45.5.

¹⁷ The latest Teubner edition of 1977 accepts the emendation. For a recent general discussion of the problem, see Norman 1984, 179.

¹⁸ As suggested by N. J. Norman (1984, 179–180).

¹⁹ Pakkanen 1996b, 153–164. On the cella wall height, see n. 31 on p. 62. The single piece of material evidence that Norman was able to connect with the Ionic order at Tegea, the small fragment of a column drum (Norman 1984, 180, pl. 31, fig. 10; see also p. A27, block 319, and p. A42 for a drawing), was studied by O. Palagia in December 1997: it has actually sharp arrises and therefore a part of a small *Doric* column, not Ionic. However, new field work carried out in June 1997 showed that the reconstruction presented in Pakkanen 1996b (fig. 8) cannot be regarded as final: The centre podium block (δ) is slightly irregular, suggesting that it could be from a statue podium. The front surface of the top podium block is previously undocumented and its top front corner seems to be deliberately hacked away, but the cut part is most probably a smooth rim and not a projecting moulding (on this “sub-toichobate” block, see Pakkanen 1996b, 157, 161). This indicates that there was originally another block in front of it, necessitating a wider reconstruction of the podium, as in the tholos at Delphi (see e.g. Pakkanen 1996b, fig. 5).

²⁰ The lower diameter of the drums of the Parthenon is 1.905 m (Dinsmoor 1950, 338); at Tegea the lower diameter is c. 1.55 m (see pp. 22–23).

A. Archaeology

A. Milchhöfer of the German Archaeological Institute at Athens was the first to conduct archaeological research at the site by excavating exploratory trenches to determine the position of the temple in 1879.²¹ G. Treu suggested that the sculptures in the museum of Piali must come from the pediments and were, therefore, original works by Skopas.²² The architectural fragments were further studied by F. Adler, R. Borrmann, W. Dörpfeld, P. Graef, and F. Graeber, and they agreed that the fragments were from the temple of Athena Alea.²³ In 1882 Dörpfeld carried out a systematic study of the foundations and the architectural remains uncovered by Milchhöfer, and he was able to present fairly accurately the peristyle plan.²⁴ In 1900 the French School at Athens purchased most of the private houses on top of the temple and full-scale excavations were started; between the years 1900–1902 G. Mendel uncovered all of the foundations except for the south-west part of the temple.²⁵ The last house on the foundations was bought by the Archaeological Society of Athens and excavated by K. A. Rhomaios in 1909.²⁶

From 1910 to 1913 the French archaeologist Ch. Dugas worked at the temple site in order to publish the excavated material and to carry out additional archaeological work: the latter task was limited to the surroundings of the altar and some very small trenches around the temple area. Dugas' chief collaborators were architect M. Clemmensen and sculptor J. Berchmans.²⁷ The result of their work was the lavishly illustrated publication of the Classical temple in 1924. Dugas had previously published an article—mainly a catalogue of small objects—on the earlier sanctuary in 1921.²⁸

In 1964 and 1965 Ch. Christou and A. Demakopoulou of the Greek Archaeological Service cleared the temple site and did limited excavation work 200 m south of the temple, uncovering some new sculptural and architectural fragments of the temple.²⁹ G. Steinhauer, also of the Greek Archaeological Service, opened seven trenches to the north of the temple in 1976 and 1977.³⁰

From 1990 to 1994 the Norwegian Institute at Athens, under the direction of E. Østby and as an international co-operation, excavated two sectors: between the two rows of Archaic foundations within the cella of the Classical temple, and

²¹ Milchhöfer 1880, 52–69.

²² Treu 1881, 393–423.

²³ Dörpfeld 1883, 274.

²⁴ Dörpfeld 1883, 275–277.

²⁵ Mendel 1901, 241–256; Dugas *et al.* 1924, X.

²⁶ Rhomaios 1909, 303–316.

²⁷ Dugas 1911, 257–258. Dugas *et al.* 1924, X–XII.

²⁸ Dugas 1921, 335–435.

²⁹ Christou—Demakopoulou 1965, 169–170, and Demakopoulou 1966, 152–154.

³⁰ Østby *et al.* 1994, 96. The work is still unpublished, but M. E. Voyatzis has studied some of the objects and Steinhauer's section drawings; see Voyatzis 1990, 21, 24–25, 52 n. 85 and 53 n. 110.

north of the temple in approximately the same area as G. Steinhauer. In the cella area it was confirmed that the foundations belong to the Archaic temple, and beneath these Archaic foundations two apsidal Geometric buildings were identified.³¹ In the northern sector the stratigraphy of the area from the early Archaic to the late Byzantine period has been established. Remains of large, collapsed mud-brick structures have been discovered in the northernmost part of the excavations.³²

B. Other Previous Studies on the Temple

After Dugas and Clemmensen, the first to undertake an investigation of the temple at Tegea was B. H. Hill: from 1946 to 1954 he studied the building in order to obtain comparative material for his work on the temple of Zeus at Nemea. He mainly used the French publication, but he also made several visits to the site. Hill presented a new reconstruction of the Corinthian capital inside the cella,³³ but otherwise his results were left unpublished until N. J. Norman was able to use Hill's work-notes for her study.³⁴ The Corinthian capital is discussed by H. Bauer as well: he suggests a slightly taller capital than Hill's reconstruction, but it is otherwise similar.³⁵

Norman's article on the Classical temple proposes a new reconstruction of the cella interior: there are Corinthian half-columns on three sides of the cella, and Ionic half-columns above them. Hill's evidence for his reconstruction of the Corinthian capital is included in the paper.³⁶

H. Knell has made an attempt to demonstrate that the ratio 6:14—number of columns on the short and long sides—can also be found at the euthynteria level of the temple, and that the normal axial spacings of the short side colonnades is 3.607 m, but neither of these observations should be accepted.³⁷ H. Bankel has

³¹ Østby *et al.* 1994, 96–107; Nordquist 1995, 27–30.

³² Østby *et al.* 1994, 107–117; Østby 1994, 46–53. During the last year of excavation, levels approaching the Geometric period were reached.

³³ Hill 1966, pl. 29 B.

³⁴ Norman 1984, 169 and n. 1. I am indebted to W. Coulson, previous Director of the American School of Classical Studies at Athens, for permission to study B. H. Hill's papers on the Tegea temple, and to C. Zerner in practical matters connected with the papers. I was not able find any important points in the notes left unnoticed by Norman.

³⁵ Bauer 1973, 65–71, 142.

³⁶ Norman 1984, 169–194.

³⁷ Knell 1983, 225. The ratio 6:14 at euthynteria level is based on a false figure for euthynteria width: 21.184 m is actually the foundation width (21.200 m in Dugas *et al.* 1924, pls. 9–11). Euthynteria edge at Tegea was slightly recessed from the edge of the foundations (Dugas *et al.* 1924, pls. 21–26 and 29), so the correct figures for the calculation of the euthynteria ratio are 21.04 m (width) and 49.40 m (length, Dugas *et al.* 1924, pls. 3–4 and 9–11). If the ratio 6:14 is used to calculate the width from the length ($6 \times 49.40 \text{ m} / 14 = 21.17 \text{ m}$), the discrepancy (0.13 m) between the calculated width and the measurement is not acceptable. In trying to redefine the axial

compared the elevations of the Tegea temple and the temple of Zeus at Stratos: it is a sound metrological study and demonstrates well the general difficulty of determining the foot units possibly used in Greek architecture.³⁸

The most complete discussion on the sculpture from the temple is A. F. Stewart's monograph on Skopas.³⁹ Very recently O. Palagia has proposed that Skopas was only the architect of the temple and that the pedimental sculptures are by a local Peloponnesian workshop. Her argument is based on literary and stylistic evidence, and as a whole, I find it quite convincing.⁴⁰

The foundations within the Classical temple's cella were independently suggested by N. J. Norman and E. Østby to be Archaic rather than belonging to a Byzantine basilica, as Dugas had proposed.⁴¹ The former briefly discusses the foundations in her paper which concentrates mainly on the cella of the Classical temple, while the latter has published an extensive article on the subject and also gives a hypothetical reconstruction of the plan.⁴²

New observations on the column height and entasis as well as the cella interior have been preliminarily reported by the author in several recent papers.⁴³

3. The Classical Temple

According to Pausanias the old temple of Athena Alea was destroyed by fire in 395/394 BC and the architect of the new temple was Skopas of Paros.⁴⁴ The foundations of the temple are mainly of conglomerate with some reused marble blocks from the Archaic temple, and the superstructure is completely of Dolianà marble.⁴⁵

The foundations of an entrance ramp to the temple on the east front are pre-

spacings of the short side colonnades Knell presents two figures for "uncontracted euthynteria length and width" which are used in the calculations. How these figures have been produced is not clear from the text and they do not fit measurements that can be otherwise calculated (Dugas *et al.* 1924, pl. 9–11: uncontracted euthynteria length would be $49.400 + 2 \times (3.582 - 3.238) = 50.088$ m, cf. Knell 50.15 m; uncontracted euthynteria width $21.040 + 2 \times [(2 \times 3.613 + 3.582) / 3 - 3.355] = 21.535$ m, cf. Knell 21.642 m), so Knell's figure for normal axial spacing on the front is also questionable.

³⁸ Bankel 1984, 413–430. On the foot units, see also pp. 67–68.

³⁹ Stewart 1977, 5–84.

⁴⁰ Palagia 1995, 4. Her monograph on Skopas is under preparation.

⁴¹ Dugas *et al.* 1924, 11–13.

⁴² Norman 1984, 171; Østby 1986, 75–102.

⁴³ See Pakkanen 1996a, Pakkanen 1996b, 153–164, and Pakkanen 1997, 330–332.

⁴⁴ Paus. 8.45.4–5.

⁴⁵ The marble has not been studied scientifically and therefore in some modern studies the building material is not identified as certainly from Dolianà; see e.g. Waelkens *et al.* 1988, 90–91. However, as the Dolianà quarries are only ca. 10 km to the south-east of Tegea, and as they show extensive traces of ancient quarrying, they are very likely to be the source of the temple marble.

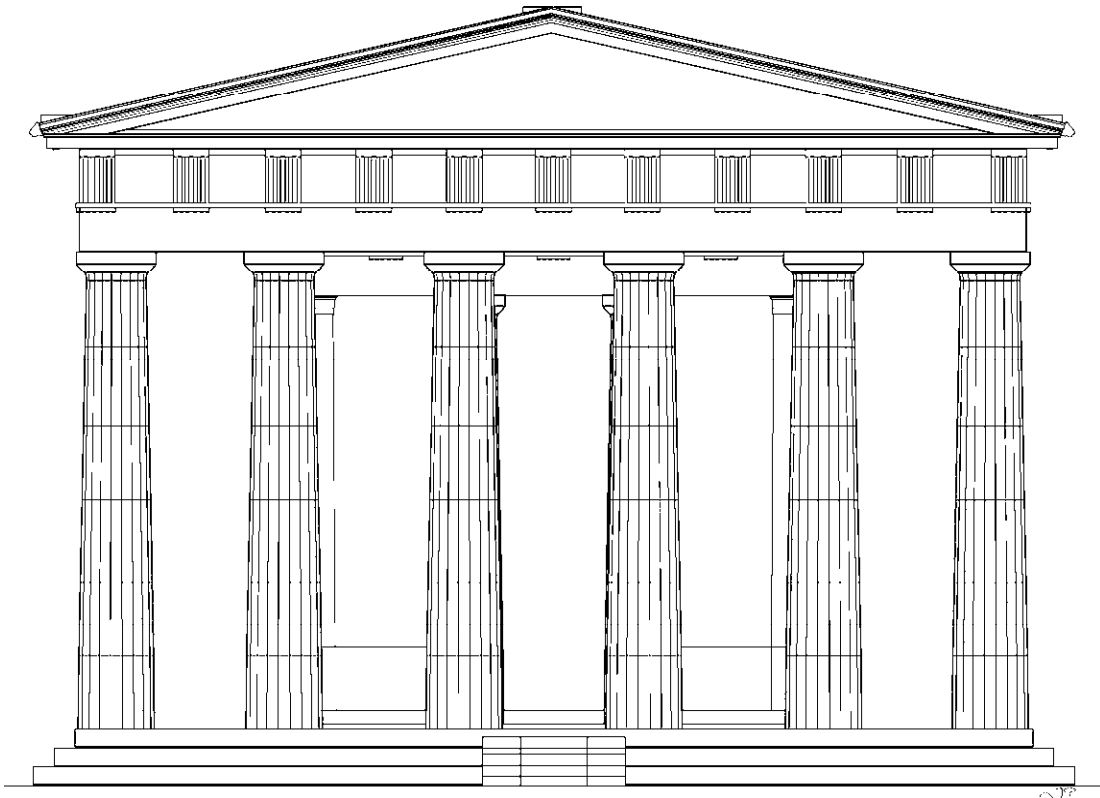

Fig. 2. The east façade of the temple of Athena Alea. Scale 1:150.

served, and the north side also has a similar structure.⁴⁶ Figures 2 and 3 present the elevation of the east façade and the plan of the temple. The plan, six by fourteen columns, is rather long for a fourth-century building; the elongated proportions of the plan of the temple are most probably borrowed from the Archaic temple.⁴⁷ The columns have slender proportions⁴⁸ and, likewise, the entablature is low compared to column height. The porches were distyle-in-antis, and as described above, in the cella the Corinthian half-columns were probably standing on a podium—no Ionic order can be attributed to the cella interior.⁴⁹ The most complete discussion of the date of the temple is by N. J. Norman: she dates it to 345–335 BC.⁵⁰ According to E. Østby, the pottery discovered in the Norwegian excavations supports the dating of the temple to the second half of the fourth century.

⁴⁶ On whether the foundations on the north flank are for a ramp or a platform, see Østby *et al.* 1994, 114–115.

⁴⁷ See e.g. Norman 1984, 172 and esp. n. 18; Østby 1986, 93–95.

⁴⁸ See pp. 72–73.

⁴⁹ See p. 5, esp. n. 19.

⁵⁰ Norman 1984, 191–193.

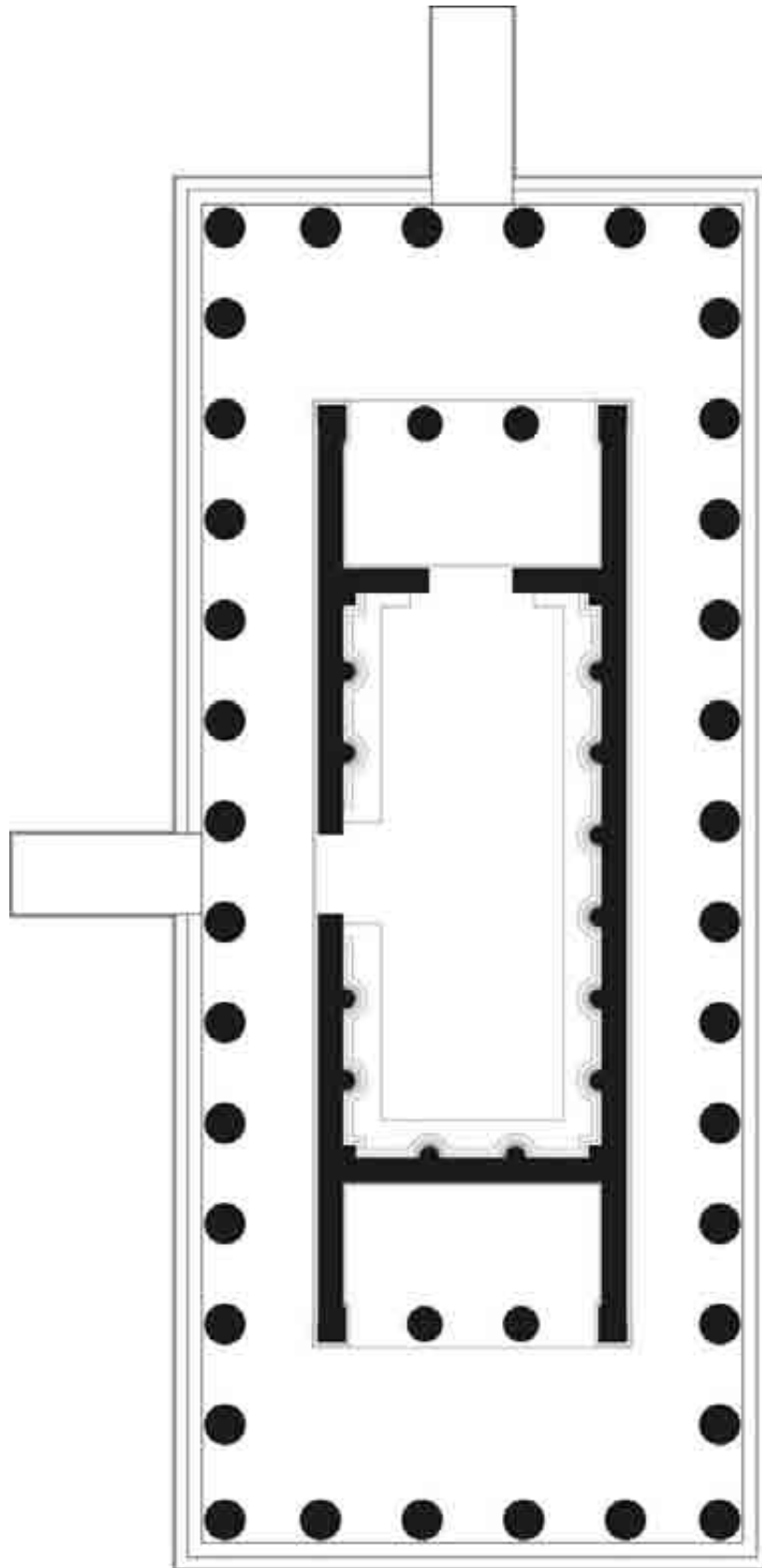

Fig. 3. Ground plan of the temple of Athena Alea. Scale 1:250.

II. Column Drums

Scattered around the temple and lifted back on to the foundations¹ there are 49 column drums which preserve the important dimensions, the full height and both the lower and upper diameters.² Clemmensen gives a list of 47 drums, but some are only fragmentary. It has been possible to identify with certainty all but two of these in the sanctuary on the basis of the published measurements and Dugas' and Clemmensen's systematic numbering of the drums.³

None of the drums are *in situ*, and only those recently excavated are certainly in the position where they were originally found during the excavations.⁴ When Mendel and Rhomaïos exposed the foundations of the temple, they excavated to a level ca. 1.5–2.0 m below the Classical earth level marked by the

¹ For the lifting of the drums, see n. 45 on p. 25.

² There are two exceptions (blocks 48 and 93), but they are the lowest drums of the column shaft, so even though their lower diameter cannot be measured they can be regarded as complete in the sense of preserving their most important dimensions. The peristyle consisted of 36 columns of 6 drums each, so at the site there were originally 216 drums belonging to the exterior order. Since all the 49 drums are from the peristyle (see pp. 27–28), 23% of the original material is well or quite well preserved. In addition to these 49 drums there are 8 blocks at the site which have been listed as whole column drums in App. A (pp. A9–42), but have at least one missing critical dimension; these include two complete drums broken into two halves (blocks 16 and 17, 487 and 495) originally listed as separate drums.

³ Dugas *et al.* 1924, app. II 131–133. On the identification of the blocks, see pp. 20–22.

⁴ Østby *et al.* 1994, 115. Mendel reported that he had found column drums as part of the foundations of the Byzantine structure to the east of the temple; see Mendel 1901, 244–245.

euthyteria blocks *in situ* on the southern flank of the temple.⁵

The most important information on column drums—measurements, drawings, and some photographs—gathered during the 1993, 1994, 1995, and 1998 seasons is given in Appendix A, which comprises four sections. In the first part, two tables, A1 and A2, list all the diameter and height measurements taken from the 49 well-preserved drums; Table A3 gives the averages and margins⁶ of the new measurements, Clemmensen's measurements, and the differences between the two. Listed separately are the cases where the difference is larger than the error margin established on the basis of new measurements (p. A8). The number of blocks in the tables is 53 because it also includes four partially preserved drums whose measurements were taken by Clemmensen.⁷ The second part of Appendix A is a catalogue of the column drums and drum fragments found at the site: a short description of the block, its most important measurements, and its coordinates are given, and for well-preserved drums a photograph is also included in order to better illustrate the present state of the block and to facilitate identification of the drum. In addition to the 135 drums and fragments of the exterior order column shaft there are at the site three well-preserved drums and two fragments of the pronaos and opisthodomos column shafts, one cella half-column fragment and one fragment of a small Doric column whose origin is unknown. These are listed in the catalogue for completeness, and to avoid mixing the preserved porch drums and fragments with the exterior order drums.⁸ The third part of Appendix A presents the schematic drawings of the bottom and top surfaces of the drums with the empolion cutting and dowel holes.⁹ These drawings were used to investigate whether the drums which fit together on the basis of measurements could actually have been a pair. Since they give the direction and flute numbering of the drums, they can be used with the catalogue as a key to where the individual drum measurements given in Tables A1 and A2 were taken.¹⁰ The final part of Appendix A is a list of possible drum pairs: it has been established on the basis of measurements, but also coded in the list is the information gathered by checking the schematic drawings of empolion and dowel holes of the two drum faces.¹¹

⁵ Dugas *et al.* 1924, pls. 6–8.

⁶ The margins have been determined by combining the following factors: range and number of measurements, the present state of the drum, method of measurement (if it was not possible to use the callipers, usual foldable measure was used), and Clemmensen's measurements.

⁷ App. A, pp. A2–8.

⁸ App. A, pp. A9–42.

⁹ At Tegea the dowels were of iron with molten lead around them. On the use of empolions and dowels to fasten column drums together, see Martin 1965, 291–296 and Orlandos 1968, 112–115. For dowels still in their original position, see p. 24 and Dugas *et al.* 1924, 55 n. 2.

¹⁰ App. A, pp. A43–59.

¹¹ App. A, pp. A60–61.

Idealised Column Shaft

Temple of Athena Alea at Tegea

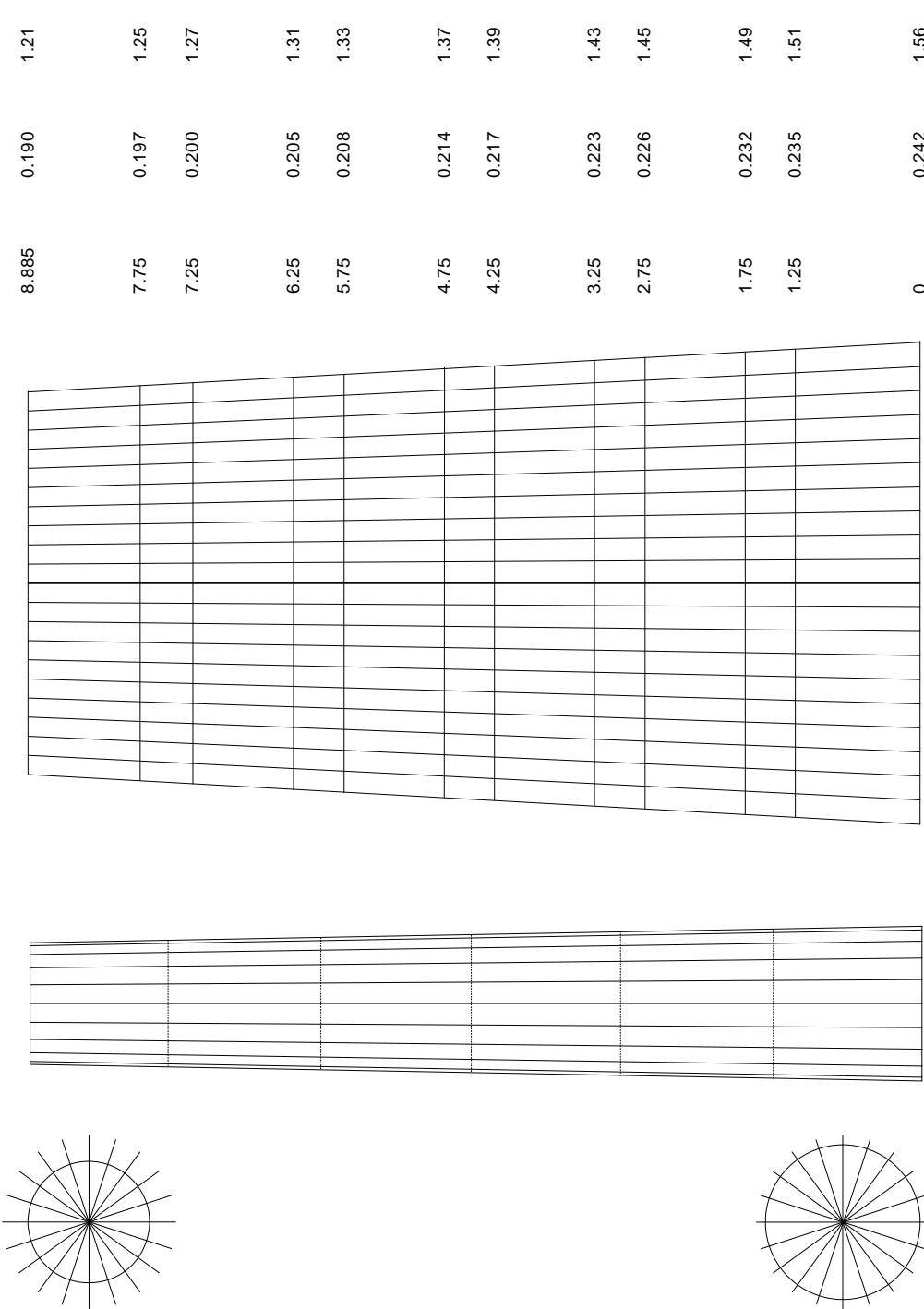

Fig. 4. Idealised column shaft of the exterior column of the temple of Athena Alea at Tegea. Entasis ignored.

1. Documentation

Before beginning the actual documentation of the column drums at Tegea, one publication proved most useful for the preparation: F. A. Cooper and C. Smith's contribution 'The Reconstruction Project: 1980–1983' in the exhibition guide *Temple of Zeus at Nemea. Perspectives and Prospects*. The exhibition was held in 1983 at the Benaki Museum, Athens. Cooper and Smith describe the documentation of the column drums at Nemea at length.¹²

A. Zone Sheets

At Nemea one of the peristyle columns is still standing, and the reconstruction research group had used this to draw an idealised image of the elevation, omitting the entasis, at a scale of 1:25. This had then been divided into eleven overlapping zones to provide space for the individual column drum drawings: the overlap ensured that each of the drums fitted completely in one of the zones. Eleven different zone sheets were drawn showing bottom and top surfaces, and a rolled-out side view of a drum.¹³

At Tegea I began by using the same method. As Dugas and Clemmensen had shown, all the columns comprised six drums and had twenty flutes.¹⁴ Initially the idealised column was drawn without entasis using the published measurements for column diameter and shaft height,¹⁵ and divided into six overlapping parts (Fig. 4), but the result was not entirely satisfactory. Comparison with Clemmensen's measurements raised some doubts as to how well the middle drums would fit into the idealised scheme: for example, Clemmensen's drum number 78 should fit in the fourth zone, but its diameter between the arrises, 1.403 m,¹⁶ is larger than the 1.39 m provided by the scheme. Therefore, the entasis of the column had to be introduced as far as possible into the zone sheets.

Taking the drum measurements as a starting point the shaft was again divided into six parts, but instead of straight shaft profile, the entasis was approximated by line segments: between the bottom and the top of the shaft the dimensions were calculated as averages of the drum measurements (Table 1).

To provide the overlap needed in the zone sheets, two of these points were taken at a time: For the first zone sheet the values at the height levels 0 and 1.470 m were taken and these were then extrapolated as a straight line up to 1.75 m for the overlap. The second zone sheet dimensions were calculated from the values at the levels 1.470 and 2.946 m, and extrapolated down to 1.25 m and up to 3.25 m.

¹² Cooper—Smith 1983, 42–64.

¹³ Cooper—Smith 1983, 56–59.

¹⁴ Dugas *et al.* 1924, 18 and 131–133.

¹⁵ Dugas *et al.* 1924, pls. 21–26, 34, and 35.

¹⁶ Dugas *et al.* 1924, 132.

Therefore, the column shaft consists essentially of overlapping line segments which are not parallel to each other: the angle between the first line segment and the vertical is slightly smaller than the angle between the second segment and the vertical. The next four zone sheets were drawn using the same method for heights 2.75–4.75 m, 4.25–6.25 m, 5.75–7.75 m, and 7.25–8.885 m. In Table 2 the dimensions derived in this way are given, and in parentheses the measurements obtained from the idealised column elevation where entasis is ignored. The differences close to the bottom and the top of the shaft are very small, but in the middle where the swelling was the greatest, the differences exceed 2 cm and justify the additional work necessary before drawing the zone sheets. Figure 5 shows an example of a zone sheet with the bottom and top surfaces of the drum, and the rolled-out circumference. It is drawn at a scale of 1:25. The dimensions above and below the side view of the drum give the height, the flute width, and the two diameters of the column shaft.

Table 1. Average measurements of the column drums (m).

Height	Diameter at the bottom of the flutes	Diameter at the arrises	Flute width
8.885	1.158	1.209	0.190
7.444	1.213	1.278	0.202
5.965	1.272	1.338	0.212
4.444	1.330	1.400	0.220
2.946	1.377	1.455	0.229
1.470	1.420	1.506	0.238
0.000	1.456	1.555	0.242

Table 2. Extrapolated values used to draw zone sheets. Values of the idealised column without entasis in parentheses (m).

Height	Diameter at the bottom of the flutes	Diameter at the arrises	Flute width
8.885	1.158 (1.158)	1.209 (1.209)	0.190 (0.190)
7.75	1.201 (1.196)	1.263 (1.253)	0.199 (0.197)
7.25	1.221 (1.213)	1.286 (1.273)	0.203 (0.200)
6.25	1.261 (1.246)	1.326 (1.312)	0.210 (0.205)
5.75	1.280 (1.263)	1.347 (1.331)	0.213 (0.208)
4.75	1.318 (1.297)	1.388 (1.370)	0.218 (0.214)
4.25	1.336 (1.313)	1.407 (1.389)	0.221 (0.217)
3.25	1.367 (1.347)	1.444 (1.428)	0.227 (0.223)
2.75	1.383 (1.364)	1.462 (1.448)	0.230 (0.226)
1.75	1.411 (1.397)	1.496 (1.487)	0.236 (0.232)
1.25	1.425 (1.414)	1.513 (1.506)	0.239 (0.235)
0.00	1.456 (1.456)	1.555 (1.555)	0.242 (0.242)

Column Drum 5/6 Temple of Athena Alea at Tegea Scale 1 : 25

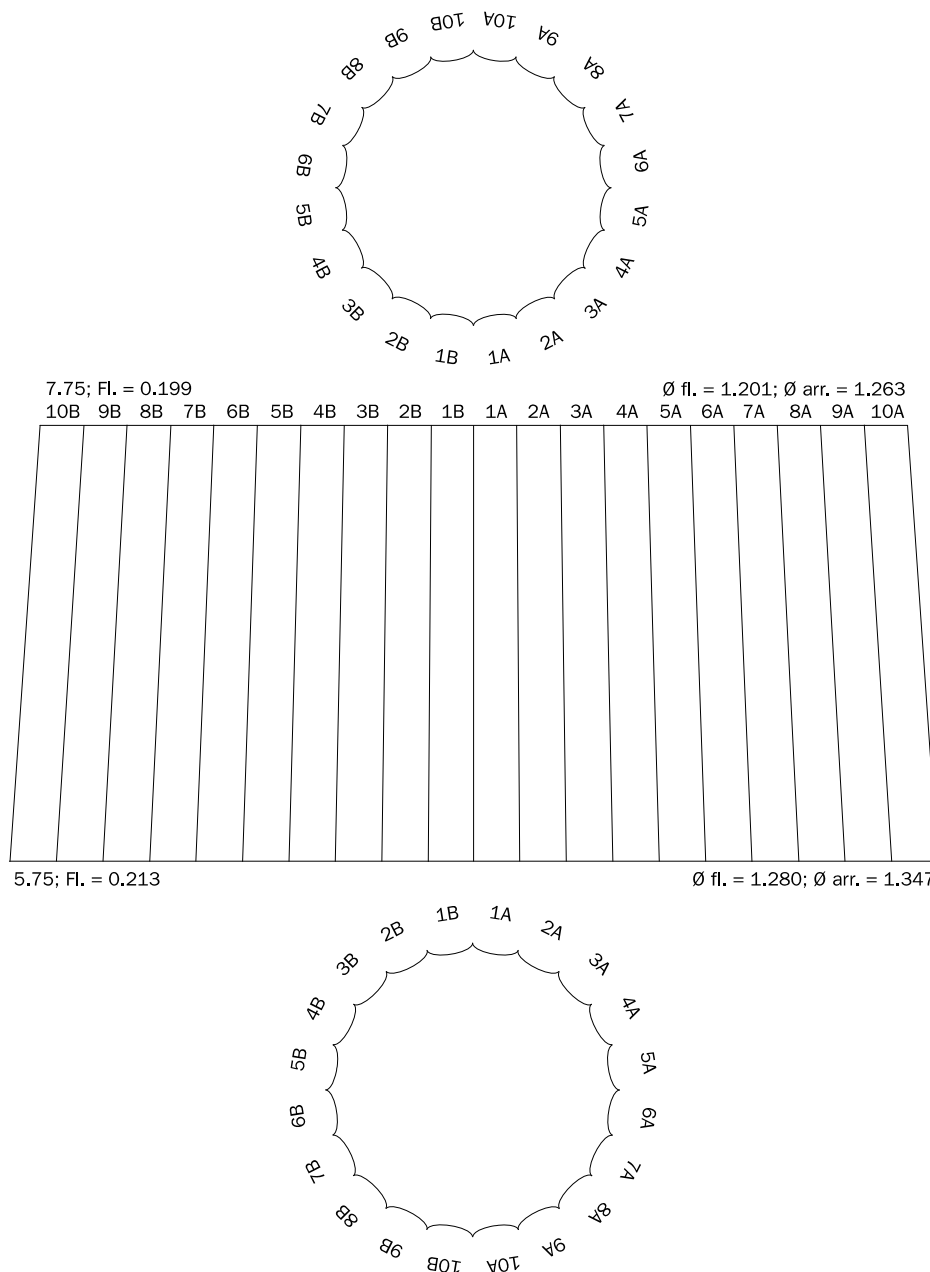

Fig. 5. Zone sheet for a column drum. Original size A4, no longer to scale.



Fig. 6. Measuring the diameter of block 3 with the large callipers.

B. The Method of Taking Measurements and Drawing

Before starting the actual documentation of the column drums in 1994, large callipers with three arms were made by a blacksmith in Tripolis, Arcadia: the length of the main arm is 1.7 m, and the two shorter arms are 1.0 m. The lengths of the arms are freely adjustable and they can be tilted at any angle in order to fit closely to the tapering sides of the drums (Fig. 6).¹⁷ Although slightly cumbersome, the callipers proved very accurate and useful. It was possible to obtain the dimensions more precisely than without the instrument, especially for the partially broken blocks.

The documentation was carried out in the same order as the blocks are listed in the preliminary catalogue of all the building blocks at the site. All column drums preserving full height and both lower and upper diameters were taken under closer study. Firstly, the lichen and moss that had gathered on the surfaces since the blocks were excavated was carefully cleaned from places where it was likely to hinder measurement taking or drawing. After cleaning, the diameter between the flutes was measured, and a large metal L-shaped square was used to determine whether the measured surface was the bottom or the top. For lower surfaces the side of the square is tight to the edge of the drum, and further along the distance between the side of the drum and the square increases. For upper surfaces

¹⁷ In the design and manufacture process of the instrument I was greatly assisted by T. Pfauth.

the end of the square touches the side of the drum, and there is a gap at the edge of the drum between the square and the block. On the basis of the diameter measurement the appropriate zone sheet was selected. The best preserved arris or, in an ideal case, two opposite well-preserved arrises were chosen; the base line was then drawn across the surface, and the diameter between the arrises measured. The flutes were also named: The flute to the right of the best preserved arris was called 1A, the next 2A, and so on up to 10A. The flutes to the left were named 1B–10B. The originating arris was called 1A/1B, and the next to the right 1A/2A, and to the left 1B/2B, etc.¹⁸ The names of the visible flutes were written on the block with a marker. Next, additional diameter and height, as well as flute width, measurements were taken and recorded on the zone sheet. The heights of individual column drums are measured along the outer edge: this is actually not the true height of the column drum, but the difference is very small.¹⁹ The positions of the empolion cutting and the two dowel holes were first measured using the drawn base line. A co-ordinate system for the drum surface was established so that the origin was the 1A/1B arris and the base line the *x* axis. Points ‘above’ the base line got positive *y* co-ordinates and ‘below’ negative.²⁰ The corner points of the holes were plotted on the sheet and the schematic picture of the drum face completed. The orientation of the block was also recorded on the zone sheet. An example of a finished zone sheet, that for block 454, is presented in Figure 7a.

Since completing the initial study of the drums, it has twice been suggested to me that variation in column fluting could be used to find matching pairs. R. Anderson, in the unpublished study of the Stoa of Attalos at Athens, has used a method which he calls taking ‘column fingerprints’: it involves drawing the current state of every flute close to both the top and the bottom of the drum with a profile gate. Differences in flute sections (width, depth, and irregularities in the carving) can then be used to search for matching drums. In the spring of 1998, M. Korres suggested a slightly simpler method, only involving measurement of the flute widths of the drums with a special instrument. Such an instrument has been used in the restoration project of the Parthenon and it also allows the broken flutes to be measured accurately.²¹ The author has adapted this instrument to suit the fluting of the Tegea temple, and it was used to measure the flute widths in the summer of 1998 (Fig. 7b).

¹⁸ See Fig. 5 for the zone sheet.

¹⁹ E.g. the measured height of block number 454 is 1.367–1.369 m, lower diameter between the flutes 1.265–1.270 m, and the upper 1.211–1.213 m. If the averages are used to calculate the true height, we get $\sqrt{1.368^2 - [(1.268 - 1.212) / 2]^2} \approx 1.368$ m. In this case there is no difference at all. On the effect of the difference on the whole column height see pp. 50–51.

²⁰ E.g. the co-ordinates for the empolion cutting corners of the block 454 bottom surface are (60,2), (69,6), (64,-8), and (74,-4). See Fig. 7 for the zone sheet of the drum.

²¹ Cf. Korres *et al.* 1989, 20, 59 n. 24 and Fig. 3.

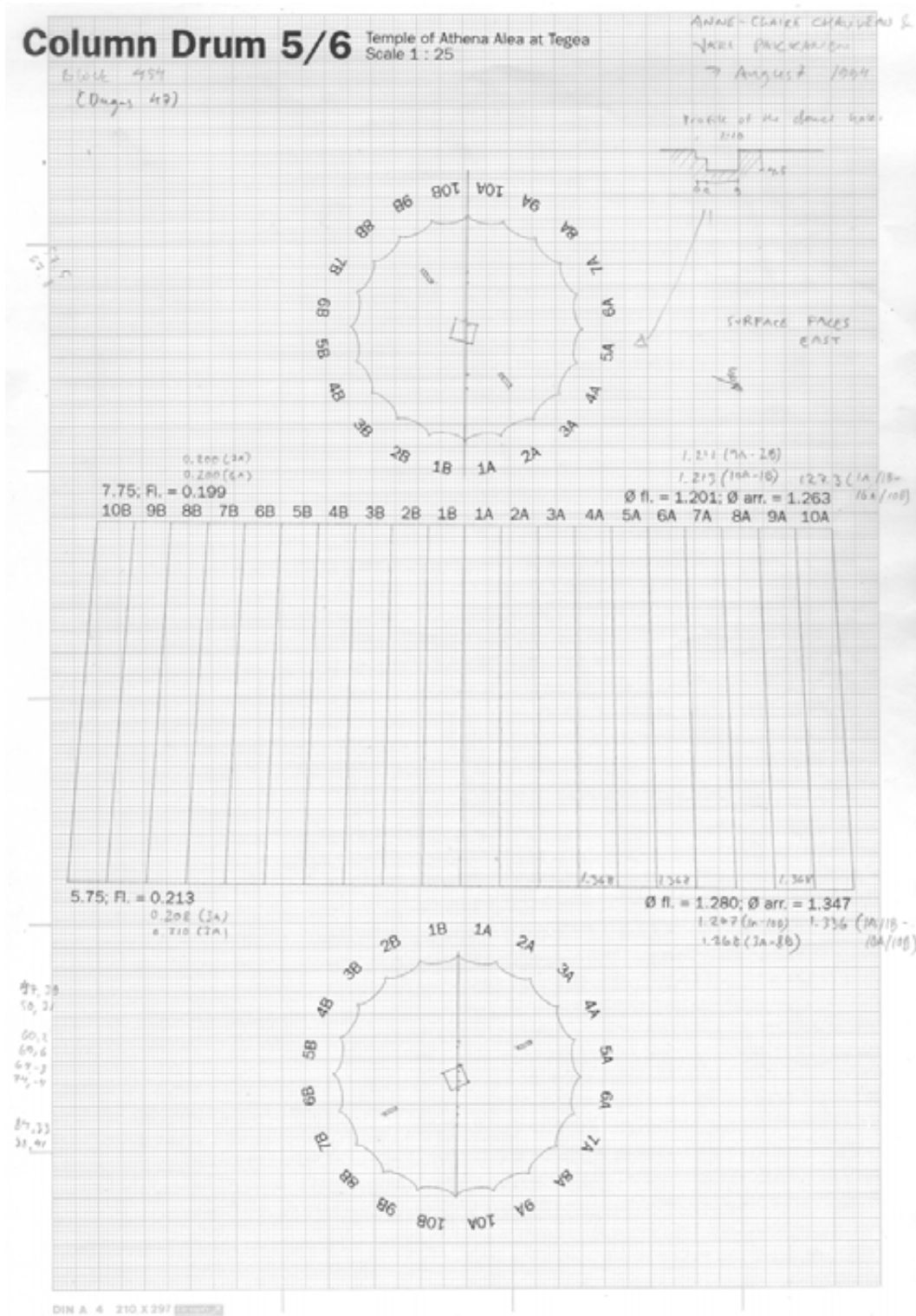

Fig. 7a. The zone sheet for block 454. Scale not the same as in the original.



Fig. 7b. Measuring the flute width of block 9 with a special instrument.

2. Identifying the Drums Numbered by Dugas and Clemmensen

The documentation confirmed that each column was made of six drums. Dugas and Clemmensen named the drum levels alphabetically from *A* to *F*, the lowest being *A*;²² the convention is followed in this study. All *C*, *D*, *E*, and *F* drums have a unique height, so identifying them on the basis of Clemmensen's published measurements was very easy. The problematic drums were those from *A* and *B* levels whose height is almost constant, and the partially preserved drums recorded by Clemmensen—the latter because a large number of fragmentary drums had been omitted in the initial study as of secondary importance.

In order to determine whether it was possible to discover Clemmensen and Dugas' pattern for numbering the blocks, all the identified drums were plotted on a site plan. The pattern of numbering became evident: it started from the east ramp and continued clockwise over the foundations; the next blocks are in the area to the east of the foundations, and from there on the numbering of the drums continues clockwise around the foundations and concludes with the drums in the north-east corner of the site.

The *A* and *B* drums were then added to the plan; the missing fragmentary

²² Dugas *et al.* 1924, 131–133.

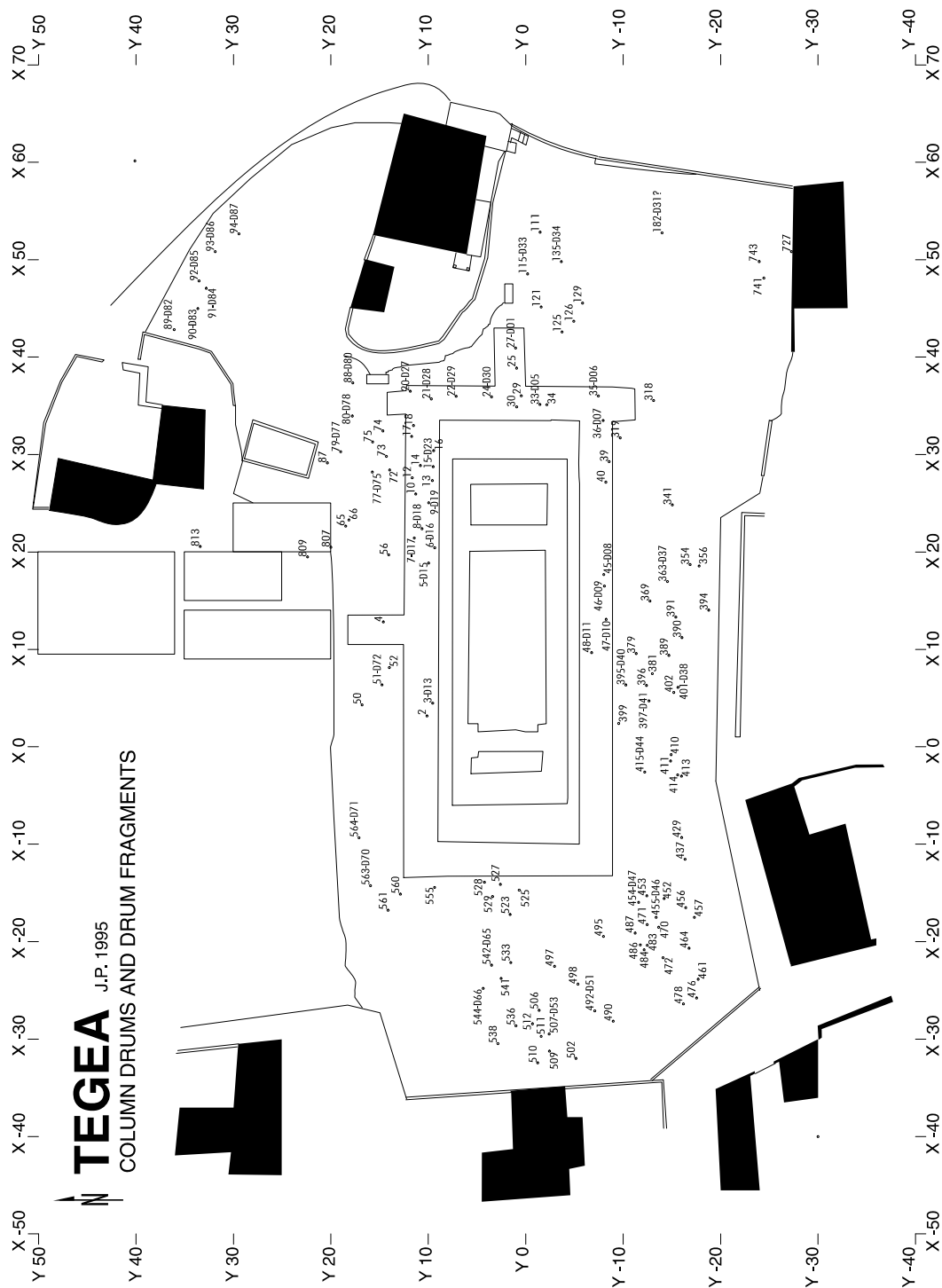

Fig. 8. Plan of column drums and drum fragments with block numbers. Dugas and Clemmensen's numbers marked with prefix D.

drums were sought in the appropriate regions of the sanctuary and identified by taking preliminary measurements. These drums also were later documented on the appropriate zone sheets. Only for Clemmensen's drum number 49—a *C* drum—was it impossible to find a match in the region south-west of the temple where, according to its number, it should have been. Drum 31 is most probably block 182.²³ Figure 8 presents a plan showing the location of all the drums and drum fragments; the column drums identified with Clemmensen's drums are labelled with both the block number and Clemmensen's number prefixed by *D*.

With the identification of the blocks numbered previously it became possible to compare the new measurements with those taken by Clemmensen. His measurements were discovered to be generally accurate: they usually fall within the error margins established by the new measurements.²⁴ Furthermore, for the drums which are currently impossible to measure, it became possible to substitute Clemmensen's values for the missing dimensions.

Clemmensen's list of drums does not include all the well-preserved drums at the site: blocks 497, 498, 506, 529, 533, 561, and 809 are missing. Only one of these, block 809, has been discovered during the new excavations, the others are to the west of the temple in an area excavated before Dugas and Clemmensen.²⁵ It is certain that Clemmensen numbered these drums also, since, in this region, his numbering is from 46 to 70, and only seven of these have been identified (Fig. 8).²⁶ No secure reason for the omission of complete drums from Clemmensen's list can be given at present.²⁷

3. Drum Features

As mentioned previously, the height of the drums in the first two levels (*A* and *B*) is almost constant, but from third to sixth level (from *C* to *F*) there is considerable variation. Taking the error margins of the measurements into consideration, the drum heights are as follows: level *A*, 1.46–1.48 m; level *B*, 1.46–1.49 m. Level *C*, 1.32–1.67 m; level *D*, 1.41–1.71 m; level *E*, 1.34–1.66 m; level *F*, 1.32–1.64 m.²⁸

The measured lower diameters of the bottom drums between the centres of opposite flutes vary between 1.453 and 1.460 m,²⁹ and the maximum measured

²³ On the block, see p. 26 and App. A, pp. A8, A26–27.

²⁴ See App. A, Tables A1–A3 and p. A8. Eight blocks were rechecked after the initial identification and in three cases the discrepancies were explained by errors in the new measurements.

²⁵ Dugas *et al.* 1924, X–XI, pls. 1–2.

²⁶ In the region there are 44 complete drums and fragments (blocks 452–563 in Fig. 8); 19 of these were left unnumbered by Clemmensen, probably because of their small size.

²⁷ There are two possible reasons: there was insufficient time to measure all the blocks, or perhaps it was thought that those already measured were adequate for reconstructing the colonnade.

²⁸ App. A, Table A3.

²⁹ With the error margins the range is 1.449–1.462 m.

diameter between the arrises is 1.535 m (block 8), but the arrises are not intact. From the two cases where the upper diameter between the arrises can be measured fairly accurately, it is possible to calculate the lower diameter of the bottom drums as ca. 1.54 m.³⁰ Since the arrises are not perfectly preserved, a slightly larger dimension of ca. 1.55 m should perhaps be preferred.³¹ The best preserved flute widths at the bottom of the drums are 0.240–0.242 m (the value calculated from the diameter is 0.242 m). Dugas and Clemmensen's observation that on the bottom drums the arris is not sharp but has a 3 mm wide flat fillet³² could not be verified, because none of the bottom drums have sufficiently well-preserved arrises.

The upper diameter of the column shaft between the flutes can be measured on five top drums, and the corresponding diameter could also be measured for three capitals. The measurement range for the drums is 1.151–1.158 m, and for the capitals 1.148–1.160 m.³³ Block 544, a column drum, has a pair of opposite arrises intact, and the upper diameter is 1.209 m. For the three capitals the measurement range is 1.196–1.209 m. Clemmensen measured the capital block 562 to have a variation of 1.209–1.213 m in the diameter between the arrises (Fig. 14 on p. 37). Thus, the established measurement range for the upper diameter of the column shaft between the arrises is quite large, 1.196–1.213 m. The best preserved flute widths vary between 0.189–0.193 m on the drums and between 0.188–0.191 m on the capitals (the theoretical range calculated from the diameters is 0.187–0.190 m). The flutes at the top of the shaft are proportionally shallower than those at the bottom.³⁴

The quality of the workmanship of the drum fluting is remarkable: very often the greatest differences in the width of the flutes is not more than 2 mm between the narrowest and widest flute.³⁵ The largest measured flute width variation in a single block is 3 mm.³⁶

It has been suggested by W.B. Dinsmoor, and more recently by H. Bankel, that the temple had enlarged corner columns.³⁷ It has not proved possible, however, to identify any trace of thickened angle columns in the drums,³⁸ and the

³⁰ The lower diameter between the arrises is calculated by solving the following equation for x : $x / \text{Diam}_{\text{UA}} = \text{Diam}_{\text{L}} / \text{Diam}_{\text{U}}$. The blocks used in the calculation are 51 and 93—the lower diameter of block 93 is impossible to measure, so the average value of 1.457 m has been used.

³¹ Dugas' and Clemmensen's suggestion for the lower diameter between the arrises is 1.555 m, but when the dimension is calculated from Clemmensen's measurements using the same equation as in n. 30 above, the result is ca. 1.545 m (drums 71 and 72, Dugas *et al.* 1924, 131).

³² Dugas *et al.* 1924, 18, pls. 34 B and 37 C.

³³ For capital measurements, see App. B.

³⁴ See p. 73, Table 13, columns C and D.

³⁵ E.g. blocks 7 and 9 which are possible to measure all around the perimeter; see App. A, p. A11.

³⁶ In blocks 506, 542, 563, and 514 (the first three are column drums and the last one a capital); see App. A, pp. A35, A39–41, and App. B, p. B5.

³⁷ Dinsmoor 1950, 339 even gives the lower diameter of the corner column as ca. 1.575 m; Bankel 1984, 413 n. 3.

³⁸ Since the heights of the A and B drums are approximately the same, the diameter measurements of these drums can be used to identify any enlarged corner columns: the measurements of the

capital block 562 (Fig. 12) mentioned above verifies this: it is a corner capital³⁹ and the maximum diameter between the flutes, 1.160 m, is only 2 mm greater than the maximum value established on the basis of drum measurements.

The anathyrosis rim—the smooth contact band—on the drum surfaces is 0.10–0.17 m wide measured from the bottom of the flute. The drums were joined together by a wooden empolion at the centre and two iron dowels; the lowest drum and the stylobate block were similarly joined together, but the highest drum and the capital were connected with just an empolion. The sides of the square cuttings for empolia are ca. 0.10–0.12 m wide and they are ca. 0.10 m deep. The dowel holes measure ca. 0.02 × 0.08–0.10 m, and their depth is ca. 0.04–0.05 m. Block 9 still has one of its top surface dowels in place, but the drum is presently upside down; the dowel is visible nevertheless, due to a small rock tilting the drum slightly. Some of the drums have a stepped dowel hole profile: in all cases they are on the upper surface.⁴⁰

A. The Lowest Drums

As Clemmensen had previously shown, the height of the bottom drums varies when measured on different sides of the drum: in the new measurements a gradual and consistent change was found, but in only two cases was it possible to take measurements almost completely around the drum. The following ranges of height measurements were recorded: block 47, 1.469–1.475 m; and block 48, 1.468–1.478 m. In three other cases it was possible to take measurements over approximately half of the drum: block 21, 1.464–1.473 m; block 51, 1.472–1.476 m; and block 564, 1.470–1.474 m.⁴¹ Of the two remaining *A* drums, block 8 has the upper anathyrosis rim broken making the measurements unreliable, and for block 93 it was only possible to take measurements over four adjacent flutes. In each case the established ranges fit those established by Clemmensen, except in one significant case: Clemmensen's drum number 10 is reported to have a constant height of 1.471–1.473 m, but it is the same drum as block 47 which clearly shows rather more height variation (see above).

Dugas and Clemmensen suggested that the variation on opposite sides of a drum was introduced in order to incline the columns toward the interior of the

seven *A* drums and eleven *B* drums show no enlargement (the values are smoothly distributed over the range of measurements, no single substantially greater dimension can be observed). The top diameters of the six *F* drums are similarly distributed.

³⁹ This is shown by two details on the block: firstly, the 9 cm wide band indicating the position of the architrave blocks at the edge of the abacus goes around the corner, and secondly, the two dowel holes are not parallel but perpendicular.

⁴⁰ Blocks 115, 454, 492, and 506: a shallow ledge 0.02–0.03 m long and 0.01–0.015 m deep is always closer to the empolion; otherwise the dimensions of the dowel holes are normal; see Fig. 7 (zone sheet of block 454) top right corner for a sketch of the dowel hole profile. I have not found any comparative material.

⁴¹ App. A, Table A2.

building.⁴² A closer study of block 48 presently positioned on the preserved part of the euthynteria on the southern flank of the building suggests a different purpose for the height variation of the bottom drums. There is a convex curve in the foundations of the building, so that if, as is reasonable to suppose,⁴³ the same curvature was used at stylobate level, the columns would have been standing on an approximately dome-shaped stylobate.⁴⁴ Since block 48 lies on an euthynteria slab ca. 2 m to the west of the centre of the southern flank, the slab should be almost level along the long side of the temple (the east-west direction) and slightly rising towards the cella wall. This hypothesis was verified with a levelling instrument. Next the top surface of the drum was checked: it was found to be level on both east-west and north-south axes.⁴⁵ When the height of the block was measured, the highest measurements were taken on the south-west to south side of the drum, and the lowest on the northern side of the block. Three flutes at the north-east could not be measured due to breakage of the drum. The height measurements agree with the results from the levelling instrument, and show that the euthynteria slab rises from the edge of the foundations toward the cella. But, more importantly, the height variation of the drum is only enough to cancel the curvature of the foundations, and since the curvature at the stylobate level was probably more or less the same as that of the foundation,⁴⁶ the columns must have been standing *vertical* instead of being inclined toward the centre.⁴⁷

This conclusion is supported by the calculated angles of horizontal curvature and column drums. The greatest angles of foundation curvature are found in the corners of the temple: in the south-west corner the angle between the west end foundations and the horizontal is 0.6° and between the south flank and the horizontal 0.5° .⁴⁸ The calculated column drum angles range from 0.2° to 0.4° , thus supporting the hypothesis that the height variation of the bottom drums could not

⁴² Dugas *et al.* 1924, 19.

⁴³ See n. 46 below.

⁴⁴ On horizontal curvature of the foundations, see pp. 42–43.

⁴⁵ It is probably no accident that the drum is placed like this; it was most probably raised on the euthynteria slab during Mendel's excavations and placed as it is. See e.g. Rhomaios 1909, pl. 5.1 where the block is already shown standing in its present position.

⁴⁶ If the curvature was to be less pronounced at the stylobate, there is no reason for the trouble of introducing curvature into the foundations, and if it was more pronounced, then the shafts would have inclined *outward*. This conclusion is also supported by the fact that the certainly identifiable blocks of the krepidoma have fairly constant height: first step, 0.340–0.347 m (9 blocks); second step, 0.358–0.366 m (15 blocks); stylobate, 0.375–0.380 m (10 blocks).

⁴⁷ On the general procedure of erecting columns and on how the refinements were executed, see Bundgaard 1957, 133–140 and especially Korres 1993b, text corresponding to figs. 27–28. Bundgaard's 'down to earth' approach can now be supplemented by Korres' proof for the use of surface plates to grind the drum surfaces to have a perfect match; see Korres 1993a, 107–109.

⁴⁸ These small angles cannot be measured directly; the given angles are calculated from theodolite measurements, see nn. 8 and 9 on p. 43.

have been used to incline the columns inward.⁴⁹

B. The Top Drums

Height variation in the top drums was also documented, but in only a single case was it possible to take measurements almost completely around the circumference of the block: the measured range for block 22 is 1.318–1.323 m. Again, it is a drum reported by Clemmensen to have a constant height (drum 29, 1.322–1.324 m). Clemmensen's second *F* drum with constant height (number 31) is most probably block 182: the height difference of 98 mm between the new measurement and the published figure can then be explained by a printing error of 10 cm in the 1924 publication. In the new measurements the block was discovered to have a constant height of 1.477–1.479 m over 11 flutes. In addition, the two other blocks where it was possible to take measurements over part of the circumference gave the following results: block 542, 1.497–1.504 m (over seven flutes); and block 544, 1.480–1.487 m (over 10 flutes). The others are not presently accessible for verification of Clemmensen's measurements, but according to him they all—blocks 77 (Clemmensen number 75), 89 (82), and 507 (53)—have a height variation of 9 mm.

Dugas and Clemmensen gave a clear explanation for the varying height of the top drums: they were used to tilt back the inclination of the column shaft, so that the abacus top surface of the capitals would be horizontal.⁵⁰ But since it has been demonstrated above that the columns were standing vertical, another expla-

⁴⁹ For inward inclination the angles should be greater than the angles of horizontal curvature. The angle between the bottom of the drum and the horizontal is calculated as following: the bottom diameter is the hypotenuse (h) and the greatest difference in height measurements (a) is taken as the length of the opposite side of the triangle, and then a is solved from the equation $\sin a = a / h$. E.g. the angle of block 47 is ca. 0.2° and of block 48 it is ca. 0.4° .

Geographically and chronologically similar cases do exist: vertical peristyle columns can also be found in the temple of Apollo at Bassai (end of 5th cent. BC; see Cooper 1996, 184) and the tholos at Epidauros (mid 4th cent. BC; see Pakkanen 1996b, 152f.). G. Roux (1961, 138 and 184) suggests that structurally the temple of Athena Alea and the tholos are so similar, that the same workers could have worked on the Tegea temple and the first phase of the tholos. Tegean workmen are actually recorded in the tholos building accounts (*IG* IV.1 103B lines 51–54; see also Burford 1969, 66). Cooper and Smith report inward inclination at Nemea (1983, 76), but this is not beyond doubt: a lower drum height variation of 0.013 m is given, and when the angle is calculated as above (bottom diameter 1.524 m from fig. 44) the result, 0.5° , is only slightly larger than at Tegea. The authors claim that they have taken into consideration the curve of the stylobate, but certainly their figure for the total inward tilt of the column, 0.081 m, has been calculated only from the height variation of the bottom drum, with the stylobate curvature being disregarded. Cooper has also written an article on some of the refinements found at Nemea, but does not discuss column inclination; see Cooper 1988. At Nemea there is also a standing peristyle column, and the original publication states that “The possibility of a designed inclination of the columns seems to be excluded.” Hill 1966, 9.

⁵⁰ Dugas *et al.* 1924, 19 and pls. 21–26.

nation for the height difference must be sought. The only possible solution is that the top drums were adjusted in this way so that the abacus tops would *not* be horizontal: the curvature of the foundations and krepidoma was in this manner transferred into the entablature of the building.⁵¹ The reason for block 182 having a fairly constant height is that it is most probably from the centre of the colonnade where very little or no adjustment is needed. The range of the angles calculated from the height variation is from 0.1° (block 182) to 0.4° (blocks 77, 89, and 507).

C. Are All the *E* and *F* Drums from the Peristyle?

The lower diameters of the pronaos and opisthodomos columns are not known, but an upper diameter can be measured from a pronaos capital (0.998 m between the flutes, 1.052 m between the arrises).⁵² The taper of the column shaft was probably approximately the same as in the exterior column,⁵³ so that a rough estimate can be obtained by solving the following equations for x (lower diameter of the porch column between the flutes) and y (lower diameter of the porch column between the arrises):⁵⁴

$$\frac{x}{\text{Diam}_L} \approx \frac{\text{Diam}_U \text{Porch}}{\text{Diam}_U} \quad \text{and} \quad \frac{y}{\text{Diam}_{LA}} \approx \frac{\text{Diam}_{UA} \text{Porch}}{\text{Diam}_{UA}} .$$

The result is that x is ca. 1.25–1.27 m and y ca. 1.34–1.36 m.

The provenance of the *F* drums is clear: even though on the basis of their lower diameters between the flutes (1.20–1.22 m) they could be from the porch orders, they all have only the empolion cutting and no dowels connecting them to a capital. Therefore, they are all from the exterior order.

Determining the original position of the *E* drums is more difficult. According to their lower diameters between the flutes (1.26–1.28 m) they could well be the lowest drums of the porch columns, but because the columns had entasis, the provenance of the *E* drums can be resolved: due to curving shaft profile, the taper of the bottom porch columns is less than the taper of the exterior order *E* drums.⁵⁵ The tapers of the preserved *E* drums are fairly uniform (range 3.7–

⁵¹ There is ample evidence for horizontal curvature in the architrave and frieze; see pp. 42–47 and esp. Fig. 18 for exaggerated distortions of the west colonnade at Tegea.

⁵² Dugas *et al.* 1924, pl. 57.

⁵³ E.g. at Nemea the proportions of the top and the bottom diameters between the arrises are approximately the same for the peristyle order (0.80) and the pronaos order (0.79), even though the pronaos columns are more slender (the height is 6.8 times the lower diameter) than the peristyle columns (the height is 6.3 times the lower diameter). For the values used in the calculations, see Hill 1966, 9 and 22.

⁵⁴ For abbreviations see p. iii. $\text{Diam}_L = 1.453\text{--}1.460$ m; $\text{Diam}_U = 1.148\text{--}1.158$ m; $\text{Diam}_{LA} = \text{ca. } 1.55$ m; $\text{Diam}_{UA} = 1.196\text{--}1.213$ m (for the values, see pp. 22–23).

⁵⁵ Cf. Korres *et al.* 1989, 15–16 and diagram 4.

4.1%)⁵⁶, and the taper of the *complete* porch shaft can be estimated as 3.1–3.5%.⁵⁷ The range also defines the taper of each drum in the unlikely situation that the porch columns did not have entasis. Therefore, it is virtually certain that the taper of the bottom porch drums was less than the range determined above. Since the preserved *E* drums have a taper of more than 3.5%, we may safely conclude that they all were originally placed in the peristyle columns.

This conclusion is also supported by the different depths of porch and peristyle fluting: for example, in block 527, an opisthodomos drum, the depth of the fluting is 34 mm, whereas in the exterior order, for a drum with the same flute width, the depth is only ca. 26–27 mm. The difference in the depth of the porch and exterior column fluting is actually large enough for visually distinguishing the two orders without measurements.

4. Arris Repairs

On two drums there are traces of ancient repairs of broken arrises: block 7 has a large rectangular cut on the south-east side, and the recently excavated block 809 has had two damaged arrises. Interestingly, one of the fixed arrises of the latter block still retains most of the marble repair pieces in place. Figure 9 shows the present state of the arris, and Figure 10 a reconstruction of the repair procedure: the broken part of the arris was cut into a rectangular shape probably with a ledge at each end.⁵⁸ Then three pieces of marble were made for the repair: two with a cutting at one end corresponding to the ledges in the rectangular cut. The left side of each of these two pieces is 3 mm longer than the right side, and the third, smaller, piece is shaped almost like a wedge (Fig. 10). The large pieces were inserted into the cutting, and the third was used to lock them into place. Finally, the repair pieces were cut down to the level of the fluting. Apparently no small dowels or lead were used to fasten the pieces together. The quality of workmanship is displayed by the fact that, even though the top part is now mostly missing, the two lower pieces remain tightly in their original places.

The second repair on block 809 and that on block 7 are larger repairs close to the end surfaces of the drums. The repair cutting on block 809 is mostly broken

⁵⁶ Calculated using the formula $100\% \times (\text{Diam}_L - \text{Diam}_U) / \text{DrH}$ and the data for *E* drums in Table A3.

⁵⁷ The height of the porch column is not certain, but the shortest suggestion is by Dugas and Clemmensen (8.176 m; Dugas *et al.* 1924, pls. 12–14) and the tallest by Norman (8.471 m; Norman 1984, 173). Taking into account the new peristyle column height of 9.544–9.580 m (see pp. 59–62), we get a height range of ca. 7.74–8.07 m for the porch shaft: $8.176 \text{ m} + [9.544 \text{ m} - 9.474 \text{ m}] - 0.509 \text{ m}$ (capital height; Dugas *et al.* 1924, pl. 57) = 7.737 m and $8.471 \text{ m} + [9.580 \text{ m} - 9.474 \text{ m}] = 8.068 \text{ m}$. The lower limit for the taper of the complete pronaos shaft can be calculated as $100\% \times (1.25 \text{ m} - 0.998 \text{ m}) / 8.068 \text{ m} \approx 3.12\%$ and the upper as $100\% \times (1.27 \text{ m} - 0.998 \text{ m}) / 7.737 \text{ m} \approx 3.52\%$ (for the pronaos shaft diameters, see p. 27).

⁵⁸ Only the top ledge is now visible, the lower only probable.



Fig. 9. Arris repair on block 809.

away with the edge of the bottom surface; the remaining part is 0.077 m wide and 0.067 m deep from the arris. The cutting on block 7 starts ca. 0.60 from the top of the drum, and has a width of 0.17 m and a depth of ca. 0.12 m from the arris. In this case the cutting itself tapers so that 0.28 m from the top surface it is only 0.145 m wide.⁵⁹ The rest of the repair cutting is broken.

⁵⁹ A tapering arris repair is recorded from the 6th cent. temple in the sanctuary of Athena Pronaia at Delphi: in this case the repair extends over two drums; see Demangel 1923, 21 and fig. 28. A triangular repair piece was used to mend the bottom of a flute in the temple of the Athenians on Delos, but there the widest part of the triangle is level with the bottom surface and the tip of the triangle is on the arris between the two flutes. The repair piece is held in place by a small clamp; see Vallois 1978, 507 n. 2 and Courby 1931, 198.

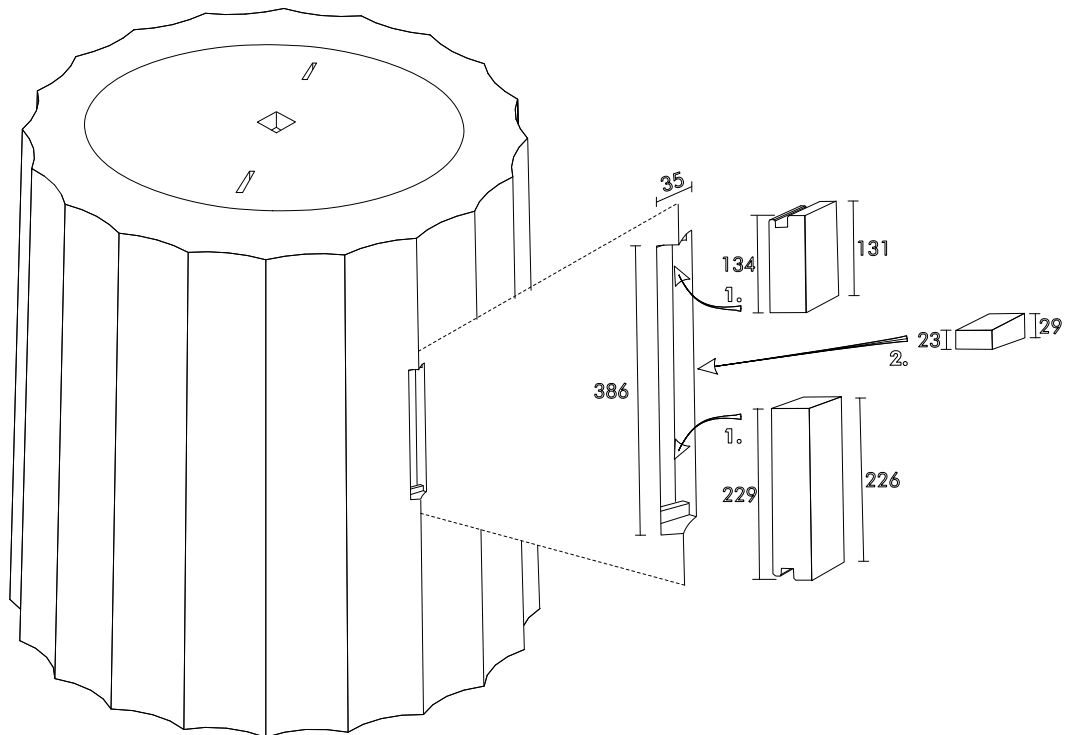

Fig. 10. Reconstruction of a largely preserved arris repair. Outer surfaces of the repair pieces hypothetical (finished when in place). Dimensions in millimetres.

III. Capitals

Ten capitals and seven fragments of the exterior order have been preserved in the sanctuary.¹ The locations of these blocks and the preserved pronaos capital are shown in Figure 11; descriptions, measurements, and co-ordinates of individual blocks are given in Appendix B.

The anathyrosis band of the bottom of the capital has a relieving edge, 3–4 mm high and recessed 20–31 mm from the flute (Fig. 12). The capital has four annulets, and the capital flutes meet the bottom ring. The profile of the capital follows the fourth-century trend: the sides of the echinus are almost straight and the groove marking the junction of the echinus and the abacus is not pronounced. In all cases where measurement was possible, the abacus face was found to be vertical, not inclined as shown in Clemmensen's drawing of the capital profile.² The top of the abacus has bands at the edges marking the position of the architrave blocks, and this, together with the information given by the dowel holes and pry marks, makes it easy to determine the orientation of the block (Figs. 13 and 14).

¹ The number is given as thirteen in Dugas *et al.* 1924, 20, but most probably some of the blocks listed here as fragments are included in that figure. One capital is located in the courtyard of a small chapel ca. 1 km south-east of the sanctuary (south of the main road from Alea to Stadio, ca. 500 m to the east of Alea). The abacus edges have been cut and the top hollowed to serve as a basin, but the flutes are still visible; their width of 0.19 m makes the identification of the block certain.

² Dugas *et al.* 1924, pl. 37.

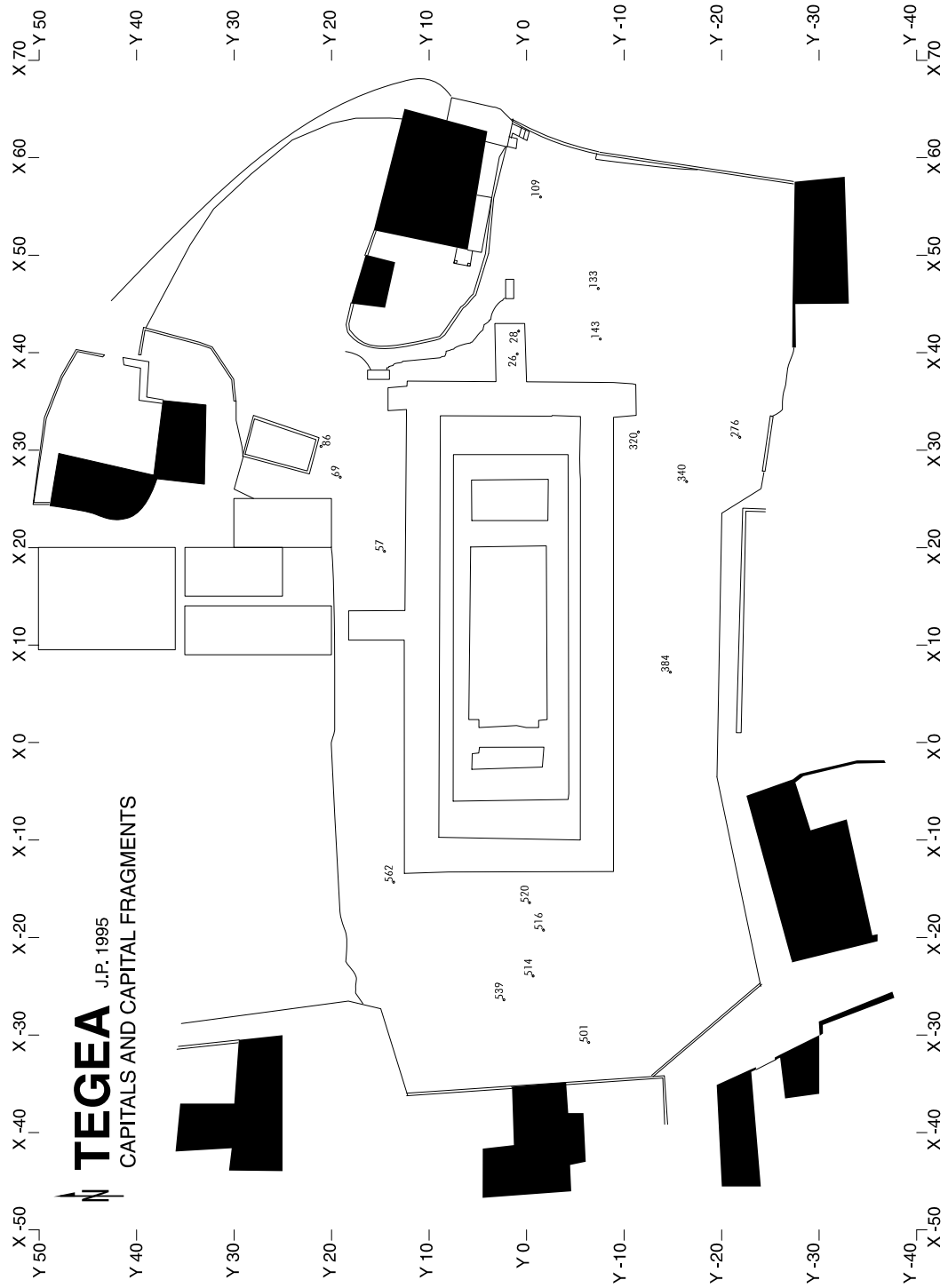

Fig. 11. Plan of capitals and capital fragments with block numbers.

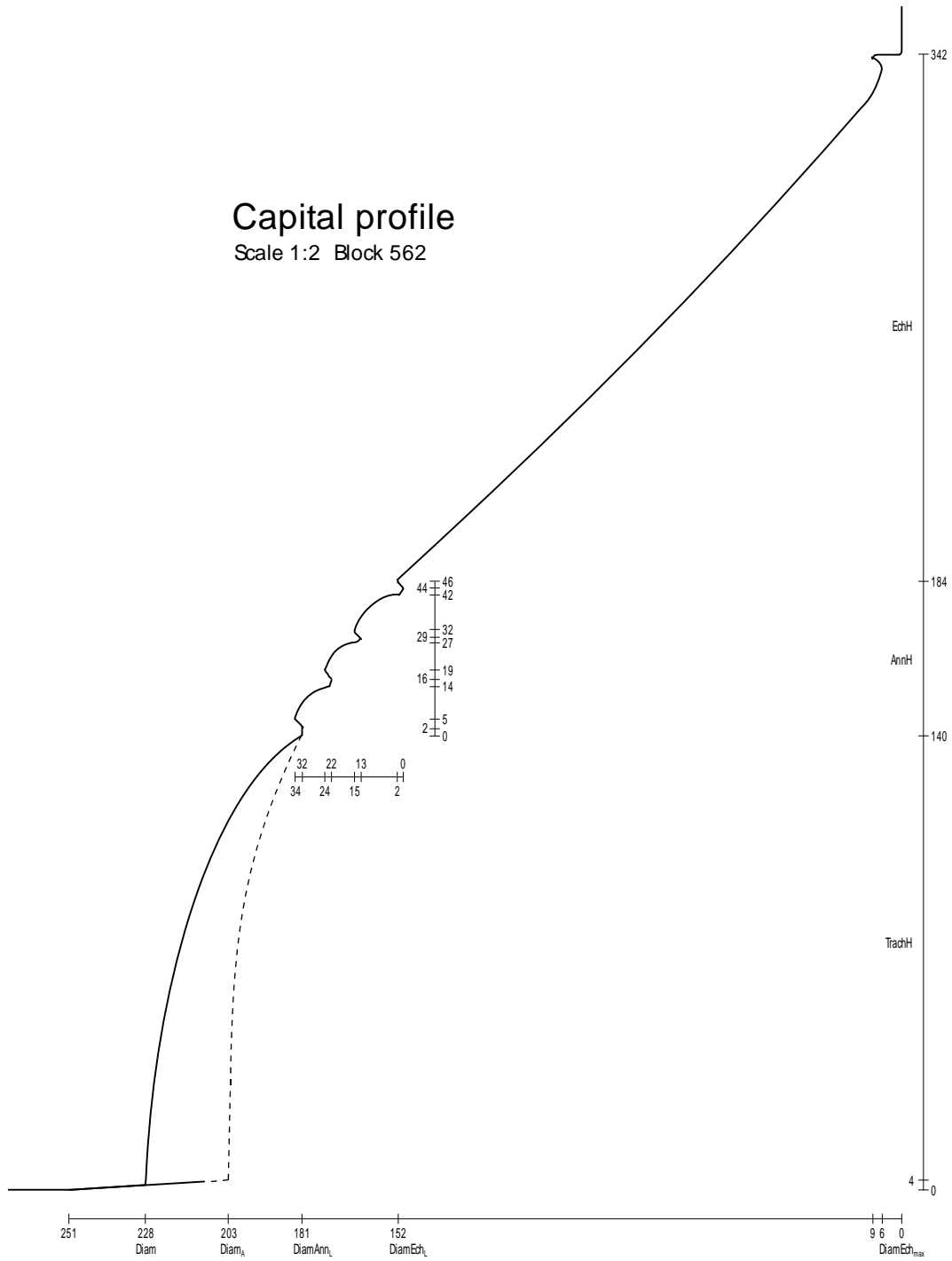

Fig. 12. Capital profile, block 562. Scale 1:2. Dimensions in millimetres.

Table 3. Capital measurements at Tegea.

	Average	No. of meas.	Range
Total height	0.596	10	0.588–0.609
Abacus height	0.246	6	0.243–0.251
Echinus height	0.161	8	0.158–0.167
Annulet height	0.047	8	0.044–0.050
Trachelion height ³	0.138	8	0.136–0.140
Abacus width		3	1.609–1.610 × 1.615–1.616 ⁴
Maximum diameter of echinus	1.596	5	1.588–1.604
Lower diameter of echinus	1.304	5	1.288–1.313
Lower diameter of annulets	1.248	5	1.234–1.255
Diameter between the arrises	1.206	3	1.196–1.213
Diameter between the flutes	1.157	5	1.148–1.165
Flute width	0.189	47	0.187–0.191

Table 4. Capital proportions at Tegea.

Block number	A.	B.	C.	D.	E.	F.
28			0.414			
133		0.499	0.407	0.280	0.687	
276		0.492				
501	0.366	0.488	0.419	0.273	0.652	0.7509 ⁵
516			0.422	0.269	0.636	
520			0.417	0.274	0.657	
539	0.377		0.399	0.263	0.658	
562	0.365	0.486	0.420	0.268	0.637	0.7506

A. Capital height : abacus width

D. Echinus height : capital height

B. Capital height : diameter between the arrises

E. Echinus height : abacus height

C. Abacus height : capital height

F. Diameter between the arrises : abacus width

In Table 3 a summary of the measured dimensions is given: it was not possible to take all measurements on all of the capitals, so in addition to the range of measurements and their average, the number of measurements is given. The range of the total height measurements is quite large, 0.588–0.609 m. Likewise, all the individual elements of the capital have slight variation in their dimensions. But surprisingly, perhaps, the variation is not proportional: Table 4 presents some of the main proportions of the individual capitals, and, for example, the variation in column *C* shows that the capitals do not have proportionally equally high abaci. Another good example is block 133 which has a low abacus (column *C*) and a

³ Includes the height of the relieving edge at the bottom of the capital; see e.g. Fig. 12.

⁴ The three measurable abaci all have the same dimensions, but one of them is from the corner of the building (562), one has the longer abacus side outward (501), and one the short side outward (539). On determining the orientation of the capital, see also n. 39 on p. 24.

⁵ The reason for the varying number of significant figures in the data of Tables 4 and 5 is due to the number of significant figures in the numerator and denominator of the proportion: e.g., in Table 4, columns *A–E* have three significant figures because at least one of the measurements used in the proportion calculation has three significant figures; column *F* has four significant figures because both the numerator and denominator have four significant figures.

Table 5. Capital proportions (from end of fifth to end of fourth century BC).

	<i>A.</i>	<i>B.</i>	<i>C.</i>	<i>D.</i>	<i>E.</i>	<i>F.</i>
Bassai, t. of Apollo (type A)	0.434	0.576	0.382	0.322	0.843	0.754
Bassai, t. of Apollo (type B)	0.453	0.593	0.382	0.322	0.843	0.763
Bassai, t. of Apollo (type C)	0.427	0.557	0.379	0.305	0.805	0.768
Argive Heraion, 2nd t. of Hera	0.41	0.55–56	0.40–42	0.30	0.72–74	0.74
Delphi, tholos	0.395	0.526	0.402	0.275	0.68	0.751
Epidauros, t. of Asklepios	0.375	0.502	0.401	0.273	0.68	0.747
Delphi, 4th cent. t. Apollo	0.380	0.524	0.43	0.24	0.56	0.7246
Delphi, 4th cent. t. Athena	0.374	0.499	0.395	0.262	0.66	0.7497
Epidauros, tholos	0.37	0.49–51	0.42	0.28	0.660	0.74–75
Tegea, t. of Athena Alea	0.365–77	0.486–99	0.399–422	0.263–80	0.636–87	0.7506–9
Megalopolis, Thersilion	0.367	0.48	0.42	0.26	0.63	0.76
Nemea, t. of Zeus	0.355	0.477	0.401	0.266	0.664	0.743
Stratos, t. of Zeus	0.371	0.505	0.400	0.269	0.673	0.735
Olympia, Metroon	0.388	0.53	0.406	0.278	0.69	0.73

A. Capital height : abacus width

D. Echinus height : capital height

B. Capital height : diameter between the arrises

E. Echinus height : abacus height

C. Abacus height : capital height

F. Diameter between the arrises : abacus width

For dimensions (and their sources) used to calculate the proportions in Table 5, see Appendix D.

high echinus (column *D*), thus creating an echinus–abacus proportion significantly larger than those of the other capitals (column *E*).

Visually the differences are insignificant: all the capital profiles can immediately be recognised as coming from the same building. However, when the proportions of capitals at Tegea are compared with the proportions of the fourth-century buildings listed in Table 5, especially on the basis of total height, abacus and echinus height proportions, the individual capitals at Tegea could be placed almost anywhere on the list. This shows not only that the variation in capital proportions at Tegea is significant, but also that no general trends can be seen in the ‘development’ of capital proportions during the fourth century. These observations should be compared with the conclusions reached by J. J. Coulton in his analysis on the proportions of Doric capitals: He suggests that proportional rules were used to design the capitals, and that when a change occurs it does so in discrete steps and not as a continuous evolution. The proportions of the fourth-century capitals were discovered to be coherent and distinct, thus implying that they were probably designed by application of the same set of rules. Evidently, the capital proportions cannot be used as evidence for dating a single capital *within* the group to which it belongs.⁶

In the light of the peristyle capitals at Tegea, Coulton’s observation that the homogeneity of the fourth-century capitals is a result of the use of proportional

⁶ Coulton 1979, 82–103.

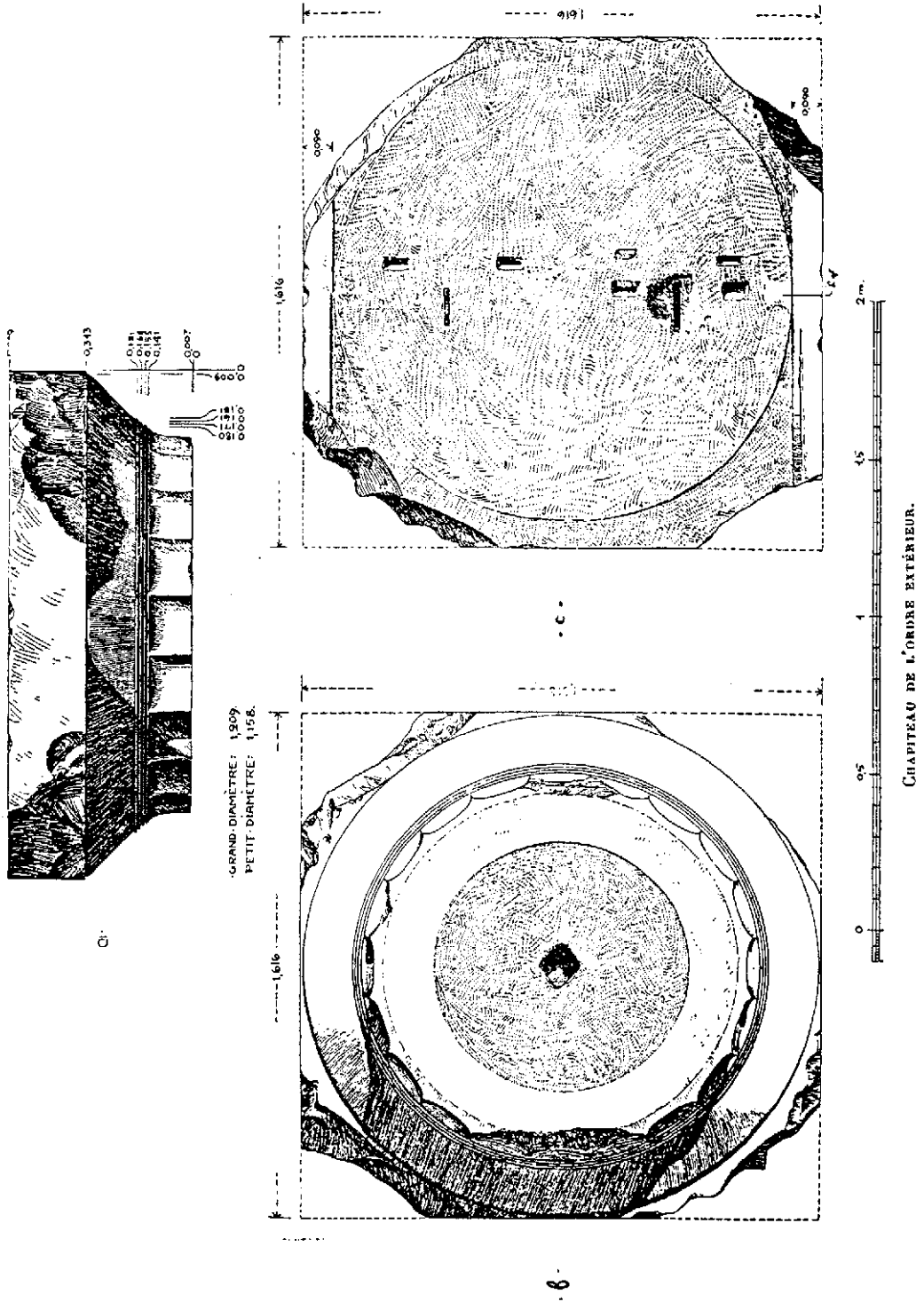

Fig. 13. Peristyle capital, block 501. (M. Clemmensen, Dugas *et al.* 1924, pl. 35.)

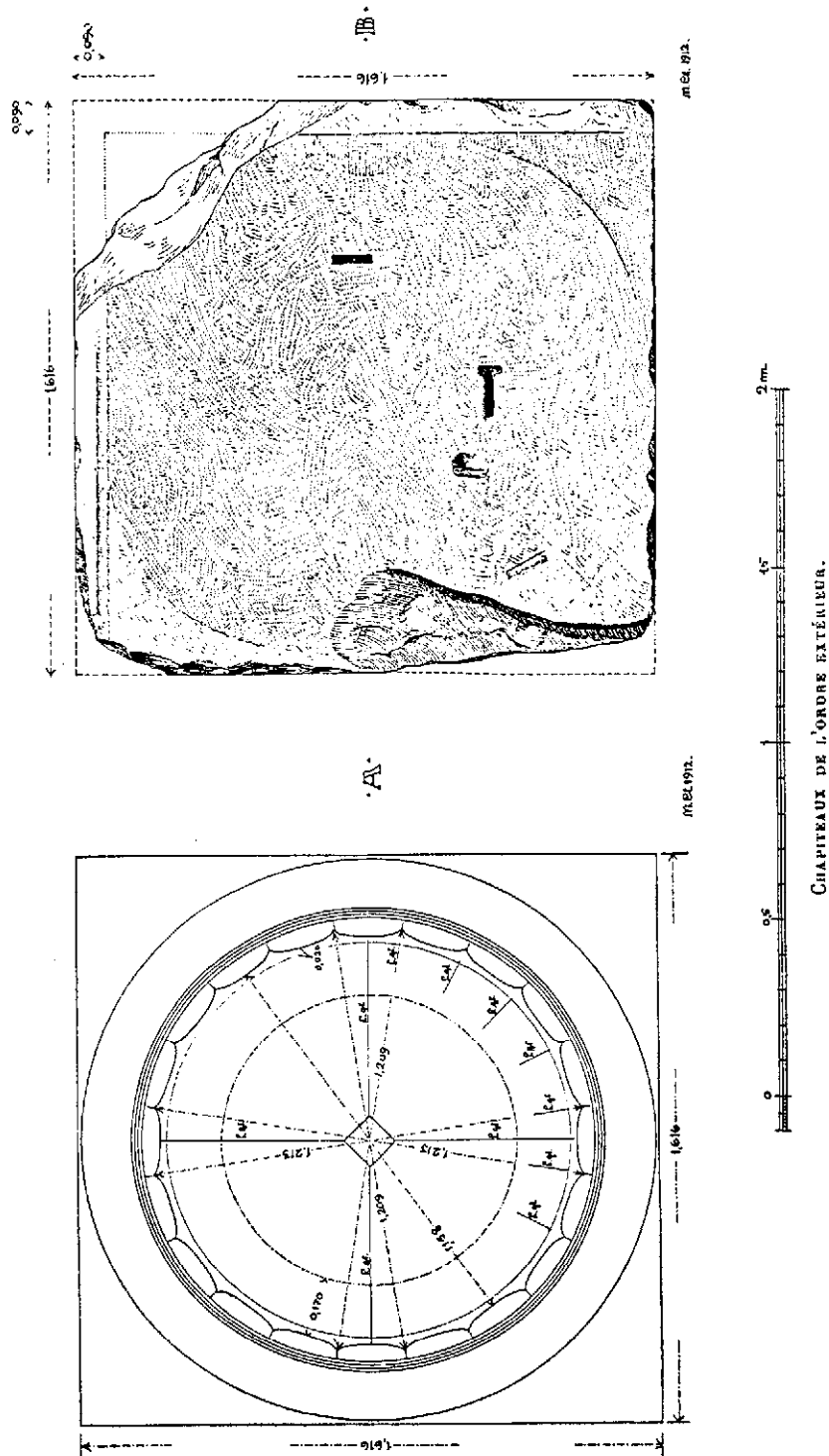

Fig. 14. Peristyle capital, block 562. (M. Clemmensen, Dugas *et al.* 1924, pl. 36.)

rules is very probably correct. The capitals of the temple of Athena Alea were probably made on the basis of one design,⁷ and the variation in their proportions could be produced either purposely or by inaccurate copying of this design.⁸ The masons at Tegea were extremely skilled, as is shown for example by the elaborately decorated mouldings inside the cella,⁹ and, therefore, it is clear that the capitals did not have to be millimetre exact copies of each other. The range of both abacus and echinus height differences is less than a centimetre: the smallest abacus height value, 0.243 m, is only 3% smaller than the greatest value of 0.251 m; the corresponding echinus heights are 0.158 and 0.167 m, the former being 6% smaller than the latter. The range of the proportion $\frac{\text{echinus height}}{\text{abacus height}}$ is 0.636–0.687,

and the proportional difference, 8%, is now greater than the individual differences, mainly due to block 133 which has a low abacus and a high echinus. Here we have a case where the capital measurements can be taken to three significant figures, but variation in the dimensions makes the *second* decimal place of the proportion range (0.636–0.687) non-significant. Generally, the third decimals in the capital proportions at Tegea should simply be ignored. The normal procedure of dating the capitals on the basis of proportional analysis requires the use of at least two and often three significant figures to elucidate the differences between the build-

⁷ Usually a full scale specimen, a *paradeigma*, was made and the capitals then copied from this; Coulton 1977, 55–57, 104–108.

⁸ In the temple of Apollo at Bassai the differences in the peristyle capital proportions were obviously intentional: “The several permutations of heights and diameters suggest a conscious and sequential alteration of elements as the capitals pass in transition from one size to the next.” Cooper 1996, 233. One possible source for the proportional variation in the Tegea data could be errors in the new measurements: great care was taken to reduce these to the minimum, by the use of appropriate tools and by rechecking the measurements.

In Greek architecture, generally, some variation in dimensions seems, in many cases, to have been preferred over ‘mathematical’ exactness. The Parthenon on the Athenian Acropolis provides classic examples, such as the abacus width of the normal column capitals which varies by almost 6 cm (1.997–2.055 m; Balanos 1938, 38), and the variation in the length of the five architrave blocks on top of the normal column bays of the east front of the Parthenon: they should all be of equal length, but the difference between the shortest and longest block is 0.18 m. The bays vary only by 0.01 m, thus causing the architrave joints to be significantly off the alignment of the columns. (Balanos 1938, dépliant no. 10). J. A. Bundgaard suggests that the differences in block lengths are explained by the reluctance of the masons to cut away more than was absolutely necessary of the blocks coming from the quarry: the four largest blocks were probably used to the full and only the shortest block cut down (Bundgaard 1957, 140f.). Quite often these examples have been overlooked even in modern studies, and the precision of the workmanship—e.g. the jointing of blocks is very accurate—is taken to apply to all of the building; on variation and accuracy, see Coulton 1975, 89–98. The refinements—the slight intentional deviations from the vertical, horizontal and rectilinear—used in Greek architecture are one aspect which suggests that variation was sought after by the architect rather than just tolerated; on refinements, see p. 41, and e.g. Coulton 1977, 108–113; Korres 1993b; Lawrence—Tomlinson 1996, 125–128.

⁹ Dugas *et al.* 1924, pls. 64–65, 74–75, and 77–80.

ings.¹⁰ Thus, the measurements taken of the Tegea capitals also support Coulton's second conclusion: the use of architectural proportions to date buildings must be reconsidered.¹¹

The abaci of the three complete capitals that it was possible to measure—blocks 501, 539, and 562—show no certain sign of having been prepared for horizontal curvature: the abacus height measurements vary by 1–2 mm, but the top surfaces are flat: no indications of angles to adjust the surfaces to the broken curve formed by the architrave blocks were detected.¹² But the adjustment of capital top surfaces cannot be ruled out: block 562 is from the corner, and if it was adapted to horizontal curvature, it would have been necessary to fit it to the curving entablature of both the short and long sides of the temple.¹³ The original position of blocks 501 and 539 is unknown: there is a clear cluster of six capitals to the west of the temple, and, if they are from the back short side of the temple, all capitals from that part of the building are preserved. The relative lack of capitals to the north and south of the temple foundations could be explained by the narrowness of the excavated trenches;¹⁴ it is quite likely that there are more capitals lying in the unexcavated parts of the sanctuary. Another possibility is that some of the capitals presently in the western part have been moved there from the flanks of the temple to be reused in some later structure. Blocks 501 and 539 could both be from the middle of the colonnades where the required adaptation is less than that closer to the corners of the temple—there is a parallel to the measured height differences of 1–2 mm at Tegea in the Parthenon colonnade.¹⁵

One partially preserved capital, block 516, was probably adjusted for horizontal curvature: on the east side of the capital the total height of the block is 0.592 m and the abacus height 0.250 m; on the south side the same dimensions are 0.595 and 0.246 m. Thus, even though the abacus height is slightly lower on the

¹⁰ See e.g. Michaud 1977, 37–39 and app. III; and more recently, Miles 1989, 160–162. Coulton has avoided the danger of inaccurate data by the use of statistics over a large number capitals, so that even if there are errors, they are less likely to lead to false conclusions. E.g. when the single error I came across in checking Coulton's figures is corrected, the proportion $AbW : Diam_{LA}$ for the Metroon at Olympia is actually consistent with the rest of the proportions (table 17: the figure for the proportion is 1.05, not 0.93684 as given; for the values used in the calculation, see App. D, Table D1 and Adler *et al.* 1982, 37). To Coulton's credit it can also be said that even though the quotients in the tables are given to five decimal places, he has not given any weight to the insignificant digits; Coulton 1979, 82–103.

¹¹ The difficulty of chronological schematisation of capital proportions has also been observed by F. A. Cooper in connection with the Bassai temple; Cooper 1996, 233.

¹² See Fig. 18 on p. 47 for a reconstruction of the Tegea west peristyle order with exaggerated distortions and adjusted abaci.

¹³ Balanos' illustrations of the Parthenon colonnade show no adjustment of the corner abaci; Balanos 1938, dépliant 10–11.

¹⁴ See the plan in Fig. 11 on p. 32.

¹⁵ In the centre of the colonnades Balanos recorded the same abacus height variation, 1–2 mm, as in the new measurements at Tegea. The maximum height difference measured by Balanos in a single capital is 7 mm; Balanos 1938, dépliant 2, 10, 11.

south face, the total height there is greater than on the east side of the block. Unfortunately, the block is only half preserved and lying upside down, so it is not possible to reach any definite conclusions. For these we must study the evidence of horizontal curvature in the foundations and the entablature.

IV. Horizontal curvature

Among modern scholars there is no general agreement as to the purpose of horizontal curvature in Greek architecture. Curvature of the stylobate is explained by Vitruvius as an optical correction: if it was level, it would appear to be hollow in the centre.¹ Even though modern empirical observation does not seem to support the optical illusion theory,² some scholars accept Vitruvius' statement on the purpose of refinements as the original intention of the Greek architects while others reject this and regard the curving lines as intentional avoidance of straight lines. The latter view is best expressed by J. J. Coulton: "they [the refinements] were intended to save a temple from a mechanical, lifeless appearance, and to create a slight and desirable tension between what the eye saw and what the mind recognised as the underlying form."³ Both of these views can be argued for,⁴ and for the stylobate curvature there is also the practical reason of shedding rain water.

¹ Vitr. 3.4.5.

² See e.g. Goodyear 1912, and Rankin 1986.

³ Coulton 1977, 109. The former view is held by e.g. Dinsmoor 1950 (1985), 165, and the latter by e.g. Goodyear 1912, 102. Rankin goes further in the rejection of the optical correction theory and regards the refinements as "visual reinforcement of the temple's stability, its load-bearing and its scale." Rankin 1986, 40.

⁴ Coulton gives the literary and archaeological support for the views: Coulton 1977, 109–110 and 175–176 ns. 24–31.

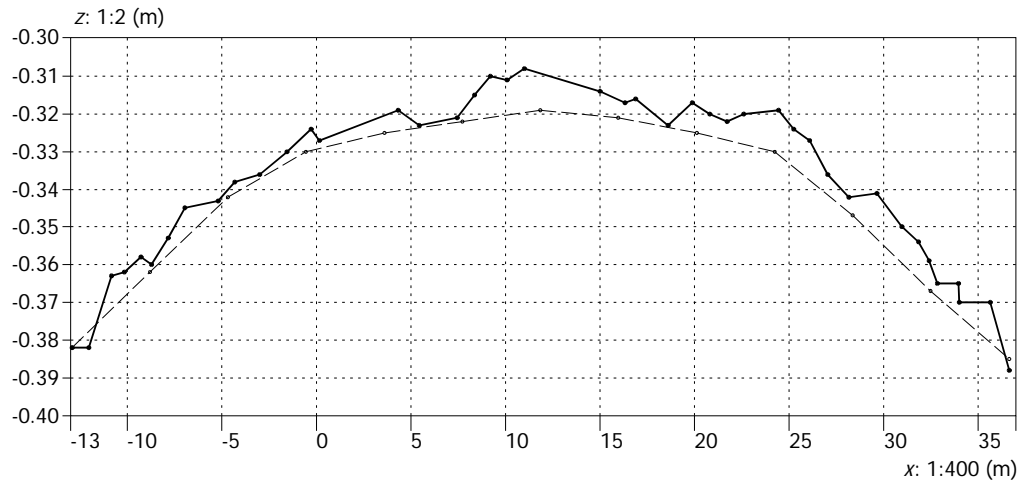

Fig. 15. Horizontal curvature of the foundations on the south long side. Values on the x and z axes are the x and z co-ordinates of the general co-ordinate system of the sanctuary. Solid line: new measurements; dotted line: Clemmensen's measurements. Scale on x axis 1:400 and on z axis 1:2.

1. Foundations

The curvature of the foundations of the temple of Athena Alea at Tegea had been measured by M. Clemmensen and Ch. Dugas,⁵ and this was rechecked in 1998 with a theodolite and an electronic distance meter. To minimise the effect of the unevenness of the top surfaces of the conglomerate foundation blocks a piece of hardboard of $600 \times 500 \times 4$ mm was used; the measurements were taken at the edge of the board as close as possible to the edge of the foundations. Only the south long and west short side of the temple could be measured, as foundation blocks on the north flank are largely missing, and the views to the edge of the east front from the current fixed station points of the theodolite are mostly blocked by column drums on the foundations. The measurements were taken from the origin of the general co-ordinate system of the sanctuary.⁶

Figure 15 shows a plot of the new measurements compared with Clemmensen's measurements on the south side from west to east. The measurements do not exactly coincide,⁷ and in general the curve in Clemmensen's measurements is slightly less pronounced than in the new ones. The foundation curve is quite symmetrical: the east end is 6 mm lower than the west, and the mid part of the foundations is 80 mm higher than the east corner. The angle between the start of

⁵ Dugas *et al.* 1924, fig. 1.

⁶ The co-ordinates of the origin station point are (0, 0, -0.366). The thickness of the hardboard has been subtracted from the measurement data used in the following discussion.

⁷ The general error margin of the EDM is 1 cm, but the error in the z co-ordinates for nearly horizontal sightings is much less: even if the prism is not held completely motionless in the horizontal plane, the height of the prism remains constant due to the supporting rod.

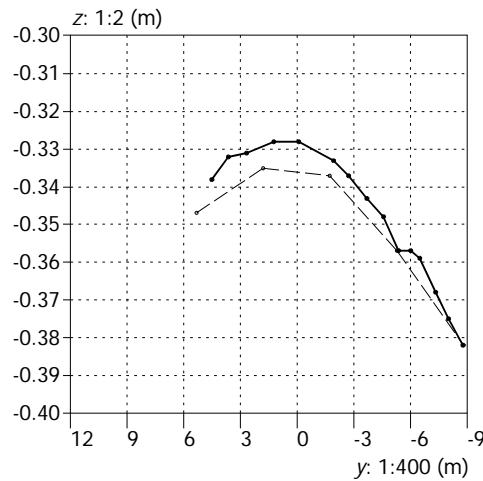

Fig. 16. Horizontal curvature of the foundations on the west short side. The blocks of the north-east corner foundations are partially missing. Values on the y and z axes are the y and z coordinates of the general co-ordinate system of the sanctuary. Solid line: new measurements; dotted line: Clemmensen's measurements. Scale on y axis 1:400 and on z axis 1:2.

the curve and the horizontal at the south-east corner of the foundations is ca. 0.5° .⁸

Figure 16 shows the measurements taken along the west short side of the temple: due to missing blocks on the north side (on the left in the figure) not all the measurements could be taken. The maximum height difference is 54 mm and the angle at the south-east corner is ca. 0.6° .⁹

The foundation curvature according to the new measurements is slightly more pronounced than that according to Clemmensen's. The solid lines in Figures 15 and 16 are not as smooth as Clemmensen's broken curves, but this is mainly due to the measurement of more data points in the new study. The horizontal curvature of the foundations is systematic and clearly intentional, and, as previously argued, the curvature at stylobate level was very probably approximately the same as at foundation level.¹⁰

⁸ The height difference between the corner and at 2.07 m to the east of the corner is 0.019 m: the angle \mathbf{a} is solved from $\tan \mathbf{a} = 0.019 / 2.07$.

⁹ The height difference between the corner and at 2.25 m to the north of the corner is 0.023 m: the angle \mathbf{a} is again solved from $\tan \mathbf{a} = 0.023 / 2.25$.

¹⁰ See pp. 25–26, esp. n. 46 on p. 25.

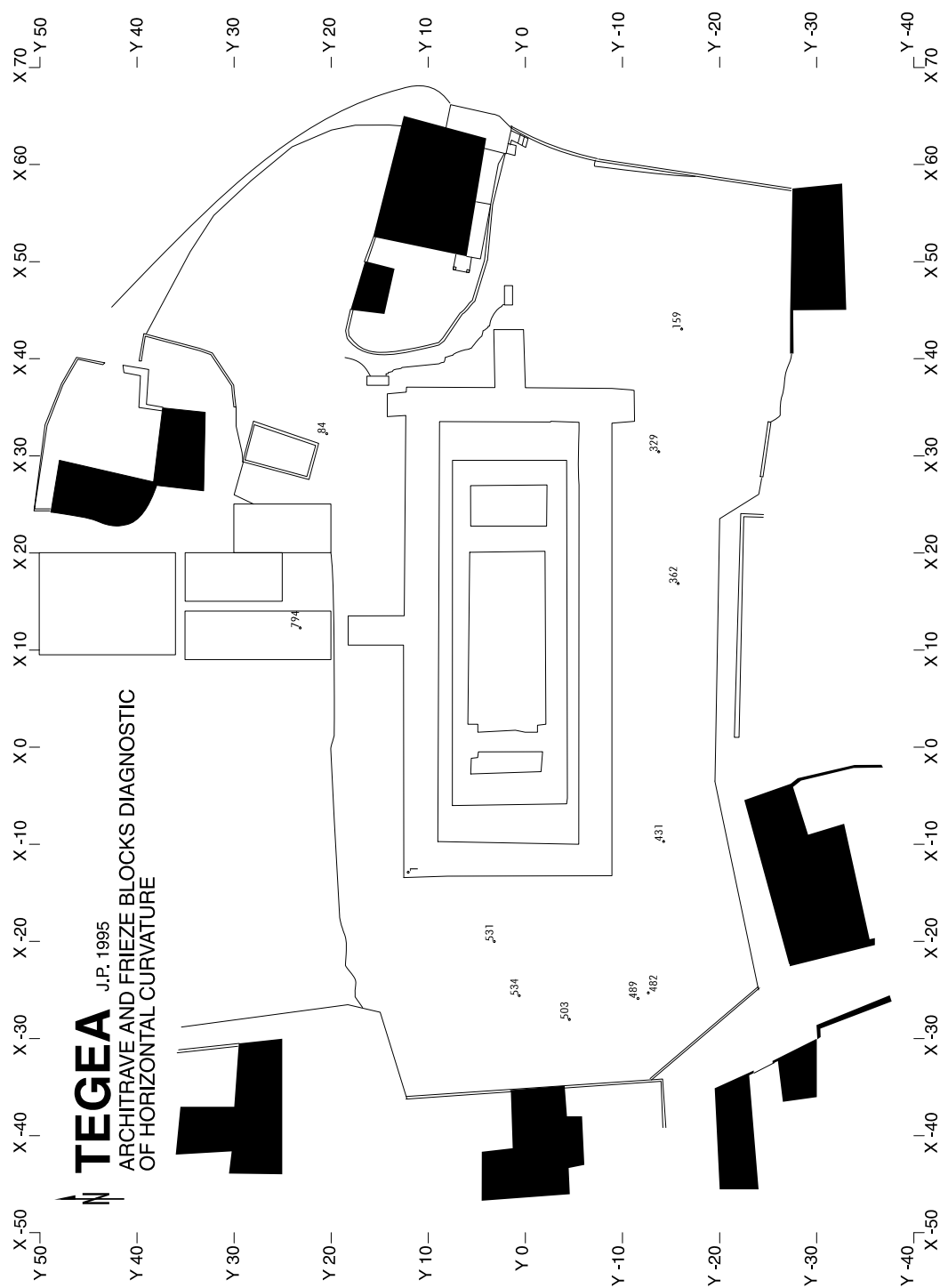

Fig. 17. Plan of architrave and frieze blocks diagnostic of horizontal curvature with block numbers.

2. Entablature

The existence of horizontal curvature in the entablature is crucial in determining the height of the columns: if the columns were standing on a curving stylobate and the architrave on top of the columns was straight, then the range of possible column heights would be quite large. For a curving entablature, however, even if the angles cannot be exactly determined, there is less height variation.

Of the 25 architrave blocks or fragments within the sanctuary, six have preserved at least one corner where it is possible to measure the angle in order to check whether it was adjusted for horizontal curvature. The statistics are similar for the frieze blocks and fragments: of the 28 blocks six have an adequately preserved corner for the purposes of this study. These blocks are listed in Appendix C and their locations in the sanctuary are shown in Figure 17.

The angle measurements of the corners were taken using a large metal square: if the angle was not 90° , one arm of the square was held tightly against one surface of the block and the distance between the other surface and the square was measured.¹¹ If the square fitted tightly to the edge of the block, then the angle was determined to be less than 90° ; angles greater than 90° caused space to be left between the square and the stone at the corner of the block. For acute angles the distance between the square and the block surface was measured as far away as possible from the corner of the block (0.715–0.82 m). In measurements of obtuse angles the tip of the shorter arm of the square touches the block surface at 0.47 m¹² and the distance at the corner was measured by use of a long steel ruler set tightly against the block surface. Calculation of the angle from these measurements is more reliable than a direct angle measurement taken at the corner with a goniometre because in this way the measurements can be taken over longer distances. All the measurements were taken by two persons.

All six of the measurable architrave blocks and three of the six frieze blocks were discovered to be adjusted to horizontal curvature: the range of angles is $89.7\text{--}90.8^\circ$.¹³ The most likely explanation for blocks having a corner cut into an angle differing from 90° is that the vertical joints of the blocks were kept at least almost vertical, but the bottom and top surfaces of the blocks were cut to form the broken curve of the entablature. Frieze block 431 has a corner cut into a

¹¹ See photographs on p. C2 of App. C.

¹² The length of the shorter arm is 0.500 m and the width 0.030 m ($0.500\text{ m} - 0.030\text{ m} = 0.470\text{ m}$).

¹³ See Appendix C. Even though it may appear that the angle measurements are calculated to three significant figures from data with one significant figure, this is not the case: the calculated angle is always a small acute angle ($0.1\text{--}0.8^\circ$) which is then subtracted from or added to a right angle. Clemmensen actually noticed the acute angle of block 159, an architrave fragment, and recorded it in his drawing of Dugas *et al.* 1924, pl. 39A, but this observation is not discussed in the publication. Block 482, an inner architrave block, has a corner cut into a right angle, but it is most probably matching with block 503, an exterior architrave block, which has the bottom surface adjusted to horizontal curvature.

right angle: it is from the corner of the building, and as the architrave block 1, the side of the block facing the façade and the top surface form a right angle (see Appendix C). The two other frieze blocks with 90° corners, 362 and 489, were possibly from the middle of the entablature where no angle adjustment is necessarily required.¹⁴ Anyhow, the joint between two frieze blocks was not visible: it was covered by the slight projection of the triglyph over the metope.¹⁵

On the basis of two architrave blocks (503 and 531)¹⁶, each with two preserved corners, it is possible to reconstruct the execution of the curvature of the architrave at Tegea. Block 503 has both corners with right angles, but there is a slight tilt in the bottom surface. The vertical side of block 531 forms an obtuse angle with the bottom surface, and an acute angle with the top. Figure 18 presents a reconstruction of the western colonnade with exaggerated horizontal curvature, and in the figure both of these blocks are placed in their original positions: block 503 is the left end of the architrave block above the centre bay of the west façade of the temple, and block 531 is the right end of the left corner architrave.¹⁷ As block 503 demonstrates, besides cutting the top of the abacus to accommodate the broken curve of the entablature (as in the Parthenon¹⁸), it is also possible to slightly adjust the bottom surface of the architrave.

The three top column drums in Figure 18 are placed in their respective places in the figure on the basis of their present location west of the temple foundations (see Fig. 8 on p. 21) and the measured height differences.

The adjustments of the bottom and top drums and the architrave blocks suggest that the horizontal curvature of the foundations, krepidoma and entablature was approximately equal; it is very probable, therefore, that all the peristyle columns were of equal height.

¹⁴ For comparison, see Fig. 18.

¹⁵ Dugas *et al.* 1924, pls. 41–43.

¹⁶ The measurements of these crucial blocks were rechecked in the 1996 season.

¹⁷ The blocks are restored to their positions on the basis of the adjustments and their present positions in the sanctuary.

¹⁸ Cf. e.g. Lawrence—Tomlinson 1996, fig. 109.

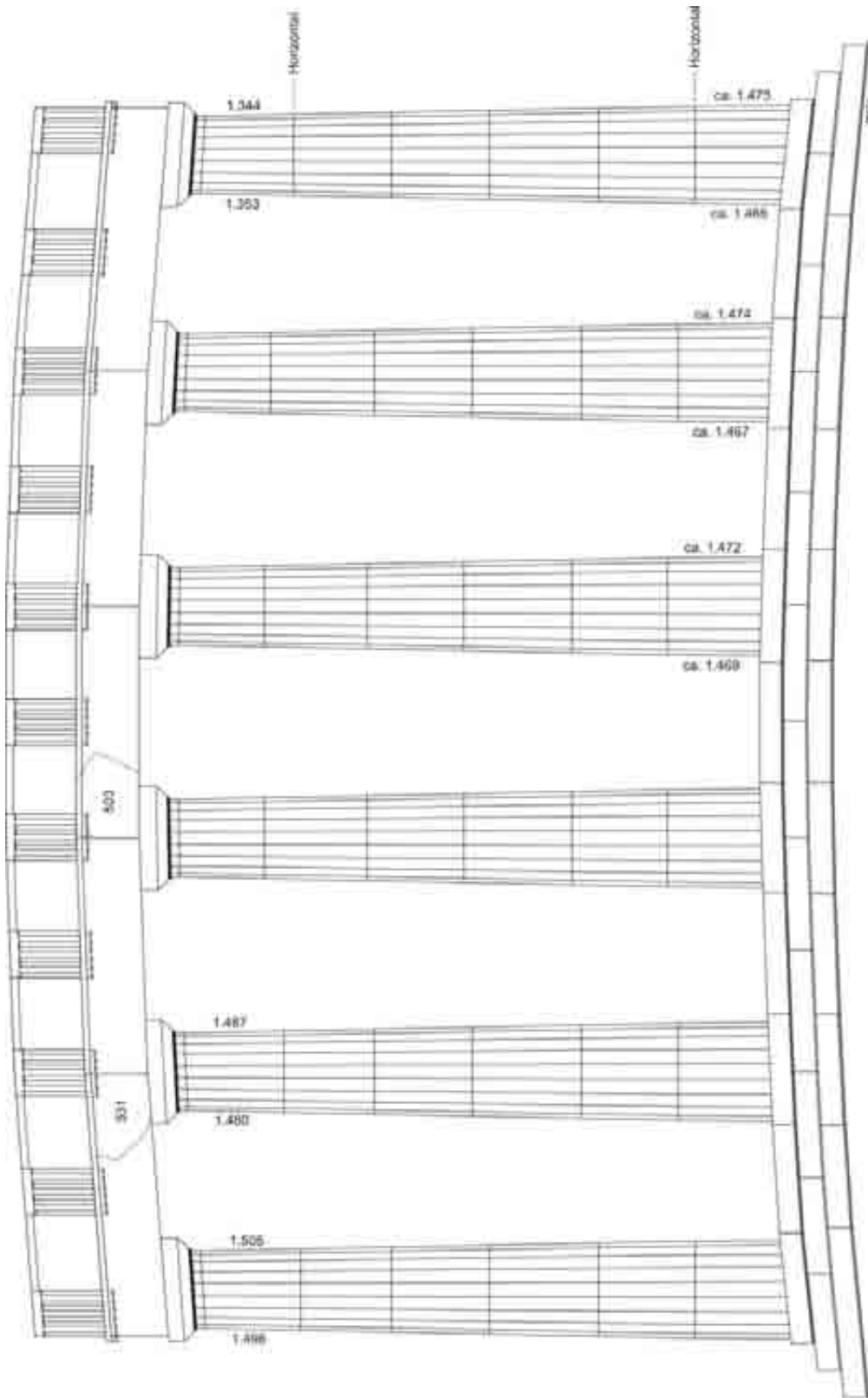

Fig. 18. Exaggerated horizontal curvature of the west facade of the temple of Athena Alea.

V. Column Height and Shaft Profile

1. The Dugas & Clemmensen Reconstruction of the Column Height

As we have seen, the height of the drums in the first two levels (*A* and *B*) is almost constant, but from the third to sixth levels (from *C* to *F*) there is considerable variation.¹ Dugas describes their method for matching the column drums as follows:

“Cette reconstruction graphique se fait de la façon suivante: soit un tambour inférieur *A*, de hauteur a , que l’on reconnaît à son plus grand diamètre à la face inférieure; on constate que, à la hauteur a de sa face supérieure, le diamètre n’est plus que $a - x$. Parmi les tambours, l’on cherche celui dont le diamètre inférieur est égal à $a - x$, et on place ce tambour, que nous appellerons *B* et qui est haut de b , au-dessus du tambour *A*. On peut ainsi dessiner la colonne jusqu’à une hauteur de $a + b$. Le diamètre supérieur du tambour *B* étant égal à $a - x - y$, on cherche ensuite le tambour *C* dont le diamètre inférieur aura cette dimension; on dessinera ainsi la colonne jusqu’à la hauteur $a + b + c$, et ainsi de suite jusqu’au tambour ayant le plus petit diamètre, tambour dont le diamètre supérieur est égal au diamètre inférieur du chapiteau.”²

Dugas’ and Clemmensen’s algorithm for reconstructing the column height is per-

¹ See p. 22.

² Dugas *et al.* 1924, 19 n. 2.

fectly reasonable, but Dugas' certainty of the exactness of their result is quite surprising,³ especially in the light of the doubts expressed by Clemmensen only slightly later.

Clemmensen's doubts are based on a comparison of measurements of the temples of Zeus at Nemea and Athena Alea at Tegea. He suggests that different foot units were used at Nemea and at Tegea and presents a table of 14 dimensions: the dimensions expressed in round numbers of 'Nemea feet' are equal to 'Tegea feet' in eight of the cases. The ninth possible match is the height of the peristyle columns. The height at Tegea does not seem to fit the pattern and it can only be expressed by using fractions of the 'Tegea foot'. Clemmensen gives two possible explanations: Firstly, there could be an error in the Tegea reconstruction. Instead of $31\frac{3}{4}$ feet the height could have been 33 feet as at Nemea. The missing $1\frac{1}{4}$ feet correspond to the height of one of the cella wall blocks. The height of the column would in this case be 9.847 m instead of the originally reconstructed 9.474 m. Secondly, he suggests that the column at Tegea could have been designed to be lower than at Nemea and that perhaps some other height, such as the height of the column and architrave together, was designed to be a round number of feet.⁴

Clemmensen's argument is not very convincing,⁵ but it is significant that he himself, in the paper, doubts the published reconstruction of the temple. The contradiction between this attitude and the emphasis of mathematical exactness in the 1924 publication is striking, but Clemmensen gives no explanation for this.⁶

2. Determining the Height of the Column

The heights of individual column drums are measured along the outer edge; this means that when one adds together the height measurements of the drums, the result is actually the length of the polygonal line which is approximately the same as the length of the column shaft face with entasis (Fig. 19). If we take a hypothetical

³ See p. 1 n. 2 for Dugas' quote.

⁴ Clemmensen 1925, 11–12.

⁵ In the worst case the proposed matching dimension expressed in feet and meters at Nemea is almost a foot unit off the mark (length of the euthynteria), at Tegea there are three dimensions for which Clemmensen did not even try to find a match, and the selection of dimensions presented in the table on p. 11 is far from being exhaustive. Also, the presented foot units for Tegea and Nemea are far from being certain: on the foot unit at Tegea and on the difficulty of determining foot units used, see Bankel 1984, 413–430; Hill's suggestion for the foot unit at Nemea 0.32565 m (Hill 1966, 9 n. 23) is significantly different from Clemmensen's 0.312 m (Clemmensen 1925, 11). On foot units and proportions, see also Coulton 1975, 85–89.

⁶ There are several possible reasons—perhaps Clemmensen did not express his lack of conviction when working with Dugas, or this issue was left out of the publication by Dugas, or perhaps Clemmensen only later came to have second thoughts—but without further evidence, no certain explanations can be given.

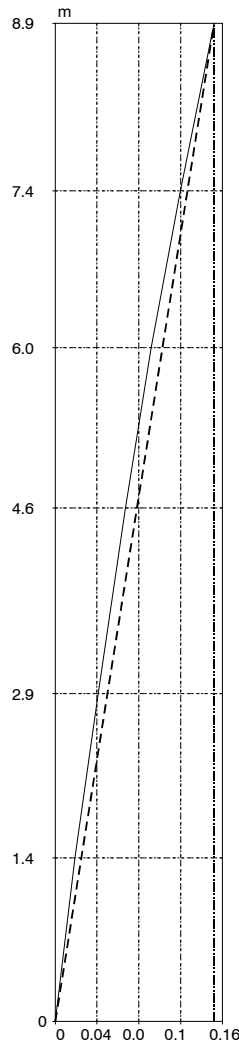

Fig. 19. Polygonal, hypotenuse, and true height of a column shaft.
 — polygonal height
 - - - - - hypotenuse
 - · - · - true height
 Differences on x axis exaggerated.

example of a column shaft consisting of blocks 51, 529, 9, 415, 401, and 542, the length of the polygonal line and the hypotenuse is 8.973 m, whereas the true height is 8.972 m.⁷ As we can see from this example, the polygonal height is only a millimetre taller than the true height; this difference is insignificant because even in a single drum the error margin of the height measurements is greater than a millimetre. Therefore, the polygonal height, rather than the true height, is used to determine the height of the column shaft. Likewise, when the height of a single

⁷ Polygonal line = 1.474 + 1.473 + 1.668 + 1.447 + 1.411 + 1.500 = 8.973 m (for the heights, see App. A); true H = $\sqrt{a} + \sqrt{b} + \sqrt{c} + \sqrt{d} + \sqrt{e} + \sqrt{f} \approx 8.972$ m, where $a = 1.474^2 - ((1.458 - 1.422) / 2)^2$, $b = 1.473^2 - ((1.418 - 1.376) / 2)^2$, $c = 1.668^2 - ((1.375 - 1.322) / 2)^2$, $d = 1.447^2 - ((1.326 - 1.274) / 2)^2$, $e = 1.411^2 - ((1.274 - 1.216) / 2)^2$, and $f = 1.500^2 - ((1.220 - 1.154) / 2)^2$; hypotenuse = $\sqrt{(\text{true H})^2 + ((\text{bottom diam.} - \text{top diam.}) / 2)^2} = \sqrt{8.9716^2 + ((1.458 - 1.154) / 2)^2} \approx 8.973$ m.

A. Classical Statistical Confidence Interval of the Shaft Height

Using classical statistics to derive a shaft height range from the Tegea drum data is fairly straightforward: the information needed in the calculation is the sample size (number of preserved drums), the population size (original number of drums), the sample mean (average height of the preserved drums), the sample standard deviation, and the t -value from the appropriate statistical table. Substituting these into the correct formula, we obtain a 95% confidence interval of 1.458–1.495 m for the drum height. In other words, we can be 95% sure that the mean drum height is between 1.458 and 1.495 m, and that the column shaft height is therefore between 8.749 and 8.967 m.⁸

Unfortunately, the matter is not this simple. There are two assumptions which have to be met before classical confidence interval calculation can be used: the sample must be random, and the original population must be normally distributed. Neither of these conditions are fulfilled at Tegea. The preserved drums do not constitute a random sample because neither the choice of the excavated area nor the process of column drum preservation at the site can be regarded as random.⁹ We do not know the height distribution of the original drums, but a height histogram of the 60 preserved drums¹⁰ gives some indication (Fig. 20): the clear peak in the middle is caused by *A* and *B* drums which are of uniform height, while the other drums are fairly evenly distributed between the minimum and maximum heights.¹¹ We have no reason to expect that the original distribution of the drums was much different, since the preserved drums account for 28% of the original number.

Fortunately, in recent years a number of computer-intensive statistical approaches have been developed which are able to deal with non-random and non-normal data. The following three sections show how it is possible to employ two of these, namely bootstrap- t and Monte Carlo analysis, in connection with the Tegea column drums.

⁸ The sample mean (\bar{x}) is 1.4764 m, the t -value corresponding to $n-1$ degrees of freedom and two-sided γ (=95%) probability level ($t_{\gamma, n-1}$) 2.001, the sample standard deviation (s) 0.082748, the sample size (n) 60, and the population size (N) 216. Substituting these into the formula

$\bar{x} \pm (t_{\gamma, n-1})s/\sqrt{n}\sqrt{(N-n)/N}$, we get the 95% confidence interval. For the t -value, see Neave 1981, 20, and for the sample size of 60, see n. 10 below. The finite population correction factor can be used in the calculation because the original number of drums is known. On confidence intervals, see e.g. Siegel—Morgan 1996, 321–330 and Shennan 1997, 77–83, and on finite population correction factor, see Shennan 1997, 363–365.

⁹ Cf. Shennan 1997, 61: “It is obvious that no archaeological sample can be considered a random sample of what was once present.” See also Edginton 1995, 6–8.

¹⁰ In addition to the 49 complete column drums (see p. 11), there are 11 drums which have the full height preserved; the heights of these drums are underlined in App. A, pp. A9–42.

¹¹ On the slight skewness of the distribution, see p. 54, esp. n. 16.

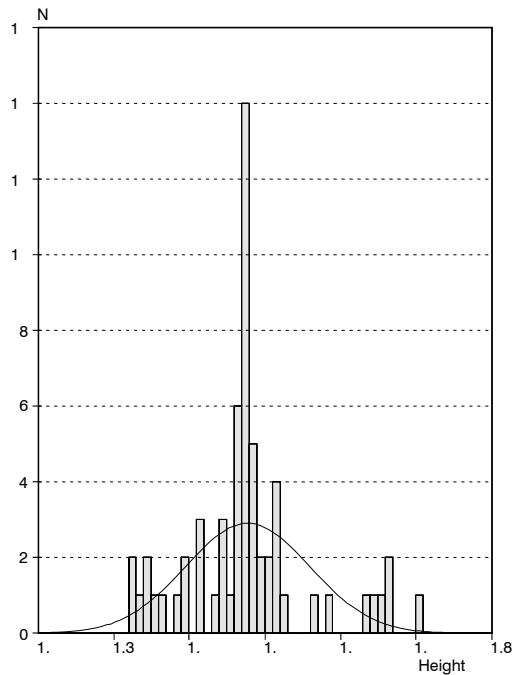

Fig. 20. Histogram of the height of the preserved column drums. $N = 60$.

B. Bootstrap- t Method for Constructing Confidence Interval

The basic principle behind the bootstrap method is that since there is no better knowledge of the population (in this case, all the original temple column drums) than the existing sample, this can be used as a guide to the population distribution. Technically, this involves taking several random resamples of the sample with replacement¹² in order to approximate, in this case, a confidence interval for the drum height. The bootstrap- t method was chosen because it does not assume that the population would be normally distributed.¹³ The method also gives reasonably accurate results even with small sample sizes, though it should not be used without evaluating its performance; the validity of the bootstrap method is discussed in the next section.¹⁴

Using the 5000 generated bootstrap values we obtain a 95% confidence interval of 1.460–1.496 m for the drum mean height and of 8.758–8.977 m for the

¹² After the drum has been selected it is returned to the sample; the probability of it being reselected is the same as the probability of any other drum being selected.

¹³ On bootstrap methods, and esp. on the bootstrap- t method, see Efron 1981, 152–154, and Manly 1997, 34, 56–59. The technique is called the bootstrap method because it “is supposed to be analogous to someone pulling themselves out of mud with their bootstraps” (Manly 1997, 34). In archaeological contexts, the bootstrap method has not been widely used (for an exception, see Ringrose 1992).

¹⁴ B. F. J. Manly (1997, 58–59) has compared the performance of different bootstrap methods with the small sample size of 20; he emphasizes that “bootstrap methods should be tested out before they are relied upon for a new application”.

shaft height.¹⁵ The bootstrap-*t* method defines a range slightly different from the classical statistics range of 8.749–8.967 m: the most probable reason for the difference is the slight skewness of the original drum height distribution (see Fig. 20).¹⁶ The relatively good agreement between a randomisation method and classical statistics is not unexpected, since corresponding cases have often been observed in statistical studies.¹⁷

C. Monte Carlo Method for Testing Bootstrap Confidence Intervals

Monte Carlo analysis¹⁸ can be used to test the validity of using the bootstrap-*t* method for calculating the confidence interval for the mean drum height. A computer model which can be used to simulate the temple colonnade at Tegea is required. It is possible to implement such a simulation model, as I have demonstrated in a recent paper analysing the preserved drums of the temple of Zeus at Labraunda, Asia Minor.¹⁹

The computer model, written in C language, can be used to simulate the

¹⁵ The formula used to calculate the *t*-statistic was $T_B = (\bar{x}_B - \bar{x}) / (s_B / \sqrt{n})$, where \bar{x}_B and s_B are calculated from each bootstrap sample (for \bar{x} and n , see n. 8 above). The minimum of the generated 5,000 t_B values was -3.905 and the maximum 3.189 ; the values limiting 95% of the distribution were $t_{\alpha/2} = 1.846$ and the maximum $t_{1-\alpha/2} = -2.186$. The confidence interval can be calculated as

$$\bar{x} - t_{\alpha/2} (s/\sqrt{n}\sqrt{(N-n)/N}) < \mu < \bar{x} + t_{1-\alpha/2} (s/\sqrt{n}\sqrt{(N-n)/N}),$$

and we obtain the interval 1.460–1.496 m; since the *t*-statistic T_B was calculated without using the finite population correction factor it is justified to introduce it in the confidence interval calculations (on the factor, see n. 8 above). The random numbers used in the generation of the t_B values are produced with statistical program Survo's *rand(n_s)* function ($1 \leq n_s \leq 2^{32-1}$) using INSEED and OUTSEED specifications (the function has been implemented by S. Mustonen; the numbers are generated according to a Combined Tausworthe generator presented by S. Tetsuoka and P. L'Ecuyer, *ACM Transactions on Modelling and Computer Simulation* 1.2, 1991. The period length of *rand* is about 10^{18}). For the bootstrap-*t* formulae, see Manly 1997, 56–58, and for the program used in the bootstrapping, see App. E, p. E1. The number of generated random values needed in the analysis is discussed in Manly 1997, 80–84.

¹⁶ Skewness of the height distribution is 0.6465.

¹⁷ See e.g. Manly 1997, 16–17. E. S. Edginton (1995, 10–13) emphasises that even though classical statistics and randomisation often produce similar results, the differences show that the consideration of the validity of the method used is also a practical issue.

¹⁸ The use of Monte Carlo methods in archaeology is not very common: P. Fisher *et al.* (1997, 584–585) give a list of archaeological studies which have employed Monte Carlo analysis, and they regret that the method “is not even mentioned by many texts in archaeological statistics”; to their list can be added a paper by B. F. J. Manly (1996), and that in the second edition of his textbook, S. Shennan (1997, 64) discusses Monte Carlo testing briefly. On Monte Carlo methods in general, see e.g. Manly 1997, 69–78.

¹⁹ See Pakkanen 1998; the computer programs used for simulation in the paper were originally programmed for the purposes of the Tegea study, but the results of the Labraunda temple study were first in print.

process of first building the temple columns, then their partial destruction, and finally the scholar's attempt to reconstruct the shaft from the remaining drums. The information input to the program is as follows: lower and upper diameter of the shaft, range of the lower diameters, column height, the amount and height of the maximum entasis, number of columns on front and flank, number of drums in one column, minimum and maximum height of each course of drums, number of preserved drums, and accuracy of taken measurements. The program uses this information to build up the column shafts, all of them randomly slightly different. The selection of the 'surviving' drums is also random. The last phase of reconstructing the possible shaft combinations is not used in the Monte Carlo analysis: only the generated drum height data is used to determine whether the shaft height given as a parameter to the program falls within the defined bootstrap intervals.²⁰

Since the exact height of the column shaft is unknown, the bootstrap-*t* confidence interval of 8.76–8.98 m was taken as the starting point of the simulations: beginning with a shaft height of 8.76 m, the process of building the colonnade and defining a bootstrap confidence interval for the mean shaft height was repeated 84 times for each height at two centimetre intervals, so that the total number of simulations was 1,008.²¹ The height ranges of each course of drums were given as follows: *A* drums, 1.46–1.48 m; *B* drums, 1.46–1.49 m; and *C–F* drums, 1.30–1.73 m.²² The confidence interval was defined by randomly selecting 60 drums; based on these drums the interval was calculated by producing 1,000 bootstrap values.

The result of the 1008 simulations is that in 955 cases (94.7%) the original shaft height is within the obtained 95% bootstrap confidence interval. The discrepancy between the expected confidence level of 95% and the obtained level of 94.7% is very small, and it may, therefore, be concluded that the bootstrap method is a valid method for determining the shaft height at Tegea.

D. Monte Carlo Test for Confidence Intervals and Non-random Data

The computer model described above can also be used to simulate the effect of non-random data on the column shaft height distribution. The simulation is done by reducing the number of columns given as a parameter to the program: if the 60 preserved drums were originally from ten columns of six drums each, we would have the complete population accounted for, so that the mean drum height multiplied by six would accurately give the shaft height. The degree of randomness can be increased by increasing the column-number parameter: the simulation was started with 12 columns, and continued at an interval of two, until 36, the number

²⁰ On the computer program, see App. E, p. E1.

²¹ 84 colonnades of 8.76 m, 84 colonnades of 8.78 m, etc. until 8.98 m was reached; $12 \times 84 = 1,008$.

²² For the height ranges of the preserved drums at the site, see p. 22. The shapes of the random drum height distributions created using these ranges are very similar to the drum height distribution shown in Fig. 20.

of columns in the temple, was reached. With 36 columns the simulation is comparable to a completely random situation. The testing was done by determining how frequently the original shaft height falls within the classical 95% confidence interval calculated from the randomly selected 60 drums.²³ The classical confidence interval was used in the tests because it requires only a fraction of the calculations needed to determine the bootstrap interval. The simulation was executed 1,008 times for each number of columns.²⁴ The results of the simulations are summarised in Table 6.

Table 6. Effect of non-random data on confidence interval.

<i>Number of columns</i>	<i>Within limits (f)</i>	<i>Within limits (%)</i>
12	1,008	100.0
14	1,004	99.6
16	1,000	99.2
18	998	99.0
20	992	98.4
22	987	97.9
24	985	97.7
26	973	96.5
28	967	95.9
30	965	95.7
32	966	95.8
34	967	95.9
36	957	94.9

Even though the fairly small number of simulations does not produce an absolutely smooth change, the trend in the coverage of the confidence interval is clear: the more random the selection of column drums, the less often the column shaft height falls within the limits of the 95% classical confidence interval. When the simulation corresponds to a completely random situation, the classical and Monte Carlo intervals converge. Therefore, the use of confidence intervals can be justified in this instance: even if the drums discovered at Tegea were from a limited number of columns and as such constituting a seriously non-random sample, the confidence interval will give a conservative estimate of the shaft height range.

In the next sections, the possibility of defining the shaft height range more accurately than the statistical confidence interval is surveyed: the key factor in this process is determining certainly matching pairs of column drums at Tegea.

²³ In order to demonstrate the effect of non-randomness, the population size N was kept as $36 \times 6 = 216$ in the confidence interval calculations; for the formula, see n. 8 on p. 52.

²⁴ The simulated heights were 8.76–8.98 at 2 centimetre intervals, and the number of simulations for each height was 84 ($12 \times 84 = 1,008$).

Table 7. Probability of matching pairs of column drums at Tegea.

n	$A \& B$	$B \& C$	$C \& D$	$D \& E$	$E \& F$
0	0.04146	0.00772	0.07880	0.18697	0.24388
1	0.19349	0.06173	0.27580	0.39833	0.42678
2	0.33605	0.19097	0.35460	0.29875	0.25607
3	0.28004	0.29955	0.21491	0.09958	0.06566
4	0.12002	0.26211	0.06541	0.01532	0.00730
5	0.02619	0.13243	0.00981	0.00102	0.00031
6	0.00266	0.03863	0.00065	0.00002	0.00000
7	0.00009	0.00631	0.00001	0.00000	
8		0.00054			
9		0.00002			
10		0.00000			
1 or more	0.95854	0.99228	0.92120	0.81303	0.75612

E. Probability of Matching Column Drums at Tegea

Calculating the mathematical probability of matching pairs of column drums will give some suggestions of what kinds of results might be expected with the excavated material. With 49 of the original 216 drums the probability of a complete shaft being preserved at Tegea is very small, only 0.4%.²⁵ However, the chances of discovering individual matching pairs is very high. The probability of the number of matching pairs is summarised in Table 7. The last line gives the sum of one or more matching pairs. For example, the probability of discovering one matching pair of C and D drums at Tegea is 27.6%, while the probability of discovering *at least* one pair is as high as 92.2%.

F. Matching Drums

The study of matching drums at Tegea involved several different phases. In the first place, the schematic drawings of empolion cuttings and dowel holes were copied from zone sheets to transparent draft papers.²⁶ The drums that could, on the basis of their diameter measurements, be matching are listed in Appendix A (pp. A60–61), and using this list as a guide, the possibly matching pairs were

²⁵ The following iterative formulae for calculating the probability have been derived by S. Mustonen:

Let $P(k, h)$ be the probability that on level k there are h preserved complete columns.

If $k = 1$ then if $h = n_1$ then $P(k, h) = 1$ else $P(k, h) = 0$.

If $k > 1$ then $P(k, h) = \sum_{j=h}^{n_{k-1}} \left[P(k-1, j) \binom{j}{h} \binom{n-j}{n_k-h} / \binom{n}{n_k} \right]$.

At Tegea the numbers of preserved drums on each level are $n_1 = 7$, $n_2 = 12$, $n_3 = 10$, $n_4 = 7$, $n_5 = 7$, and $n_6 = 6$, and the number of columns $n = 36$. The probability of one or more complete columns being preserved can be calculated as $1 - P(6, 0) \approx 0.00408$. The calculations were performed using editorial arithmetics in the statistical program Survo.

²⁶ Copies of these are in App. A, pp. A43–59.

checked from the drawings. For example, the upper faces of *A* drums were compared with the lower faces of *B* drums; for the comparison, the sheet for *B* drums must be turned upside down in order to imitate the situation with real drums. This procedure was followed through for all the possible matching drums. The information gathered during the process is typographically coded in the list of matching drums.

The placement of the empolion and dowels was confirmed to be characteristic of each block: the distance between the cuttings and their orientation compared to flutes and to each other varies considerably; also the dowels are quite often asymmetrically placed on the two sides of the empolion. Three pairs of drums were discovered to be matching according to the 1:25 drawings.²⁷ In addition to these, five pairs were discovered to be possible matches, but they had the other or both surface drawings incomplete with, for example, only one dowel hole.

When the three matching drum pairs were rechecked and drawn at a scale of 1:10 in 1995, only one pair was found to actually match: the pair consisting of a *D* drum 35 and an *E* drum 115. The upper surface of block 35 is shown in Figure 21 and the lower surface of block 115 in Figure 22.

A different method for determining matching pairs of drums was experimented with in 1998: the flute widths were measured with a special instrument and the slightly varying flute width sequences of different drums were compared. A new pair comprising of a *C* drum 9 and a *D* drum 7 was discovered: the drums are located on the temple foundations very close to each other. The pair was originally missed because the top surface of the *C* drum and the bottom of the *D* drum are currently against the foundations and only partially visible.²⁸ The flute width sequences of the two matching pairs are presented in Table 8. Since the edges of the surfaces were largely broken on all the blocks, the flute width measurements are taken at ca. 0.20–0.30 m above or below the joint; the flute widths are, therefore, listed as differences of the mean value (the range is $-1 - +2$ mm). The flute widths of blocks 35 and 115 overlap for six flutes, and only one of the overlapping flutes can be measured accurately on both of the drums. The result of the flute width comparison is more reliable in the case of the second matching pair of drums: the measurements can be taken for 17 overlapping flutes, and of the six flutes which it was possible to measure accurately, only one shows a discrepancy of 0.5 mm. All the other flutes match within the measurement accuracy.

²⁷ The corners of the empolion cuttings would not have to coincide exactly due to the construction of the empolion: the small square wooden blocks are only needed to hold the centring pin. But since matching empolion cuttings produced good results at Nemea, where there are no dowels, this method was also adopted at Tegea. On Nemea, see Cooper—Smith 1983, 63–64.

²⁸ On the basis of the positions of the visible dowel holes and the empolion cuttings the two drums could be matching.

Table 8. Flute width sequences of the matching pairs of drums.

35	-	(0)	(0)	(0)	+1	(+1)	(0)	+1	+1	0	+1	0	(+1)	(+1)	-	-	-	-	-	-
115	(-1)	(0)	(0)	-	-	-	-	-	(+1)	(-1)	+1	(0)	(0)	(0)	0	(0)	(0)	(+1)	(0)	0
9	(0)	(0)	-1	+1	0	0	+1	+1	(0)	0	+1	0	+1	(0)	(+1)	0	(0)	0	0	0
7	0	0	-0.5	(+1)	(0)	0	(0)	(+1)	(0)	0	(0)	0	+1	+1	(+2)	0	+1	-	-	-

The measurements of the same flute are listed one above the other. The parentheses denote flutes with partially broken arrises indicating a possible discrepancy of ± 1 mm with the given figure.

G. Height of the Column Shaft

Using the pairs of column drums ascertained above it is possible to attempt to define the shaft height more accurately than the 95% confidence interval. Since the shaft height is partially determined by the matching pairs, determination of the confidence interval is only necessary for the rest of the shaft: taking the pair comprising the blocks 35 and 115 (*D* and *E* drums), the 95% bootstrap-*t* confidence interval for the mean height of *A*, *B*, *C*, and *F* drums can be determined as 1.454–1.493 m and for the shaft height as 8.891–9.046 m.²⁹ The difference between this confidence interval and the previously determined bootstrap interval of 8.758–8.977 m is due to the matching pair being slightly taller than the average drums. Cutting the non-overlapping tails off, it is possible to establish the new limits as 8.891 and 8.977 m.

The procedure can be repeated for the second pair of blocks 9 and 7 (*C* and *D* drums). The confidence interval for the mean height of *A*, *B*, *E*, and *F* drums is 1.442–1.482 m and for the shaft height 8.952–9.111 m.³⁰ Both of the drums in this pair are significantly taller than average drums, so the limits of the confidence interval are also greater than the previously defined limits. In fact, the intervals have an overlap of only 2.5 cm, thus allowing the shaft height to be determined as 8.952–8.977 m at a confidence level of 95%. The bootstrap confidence interval of the mean capital height is 0.592–0.603 m,³¹ so that the confidence interval of the

²⁹ The minimum of the generated 5,000 bootstrap *t*-values was -3.7938 and the maximum 3.8287; the values limiting 95% of the distribution were $t_{\alpha/2} = 1.976$ and $t_{1-\alpha/2} = -2.101$. Other variables substituted into the confidence interval formulae of n. 15 (p. 54) above were $\bar{x} = 1.4733$, $s = 0.070907$, $n = 40$, and $N = 4 \times 36 = 144$. The minimum of the shaft height range was calculated as follows: 1.493 [height of block 35] + 1.580 [height of block 115] + $(4 \times 1.4544) \approx 8.891$ m; the maximum: 1.493 + 1.580 + $(4 \times 1.4933) \approx 9.046$ m.

³⁰ The minimum of the generated 5,000 bootstrap *t*-values was -3.9087 and the maximum 3.5060; the values limiting 95% of the distribution were $t_{\alpha/2} = 2.016$ and $t_{1-\alpha/2} = -2.093$. Other variables substituted into the confidence interval formulae of n. 15 (p. 54) above were $\bar{x} = 1.4619$, $s = 0.070993$, $n = 39$, and $N = 4 \times 36 = 144$. The minimum of the shaft height range was calculated as follows: 1.668 [height of block 9] + 1.514 [height of block 7] + $(4 \times 1.4424) \approx 8.952$ m; the maximum: 1.668 + 1.514 + $(4 \times 1.4823) \approx 9.111$ m.

³¹ The minimum of the generated 5,000 bootstrap *t*-values was -14.067 and the maximum 4.2657; the values limiting 95% of the distribution were $t_{\alpha/2} = 1.9089$ and $t_{1-\alpha/2} = -3.2667$. Other variables substituted into the confidence interval formulae of n. 15 (p. 54) above were $\bar{x} = 0.5961$, $s = 0.007978$, $n = 10$, and $N = 36$.

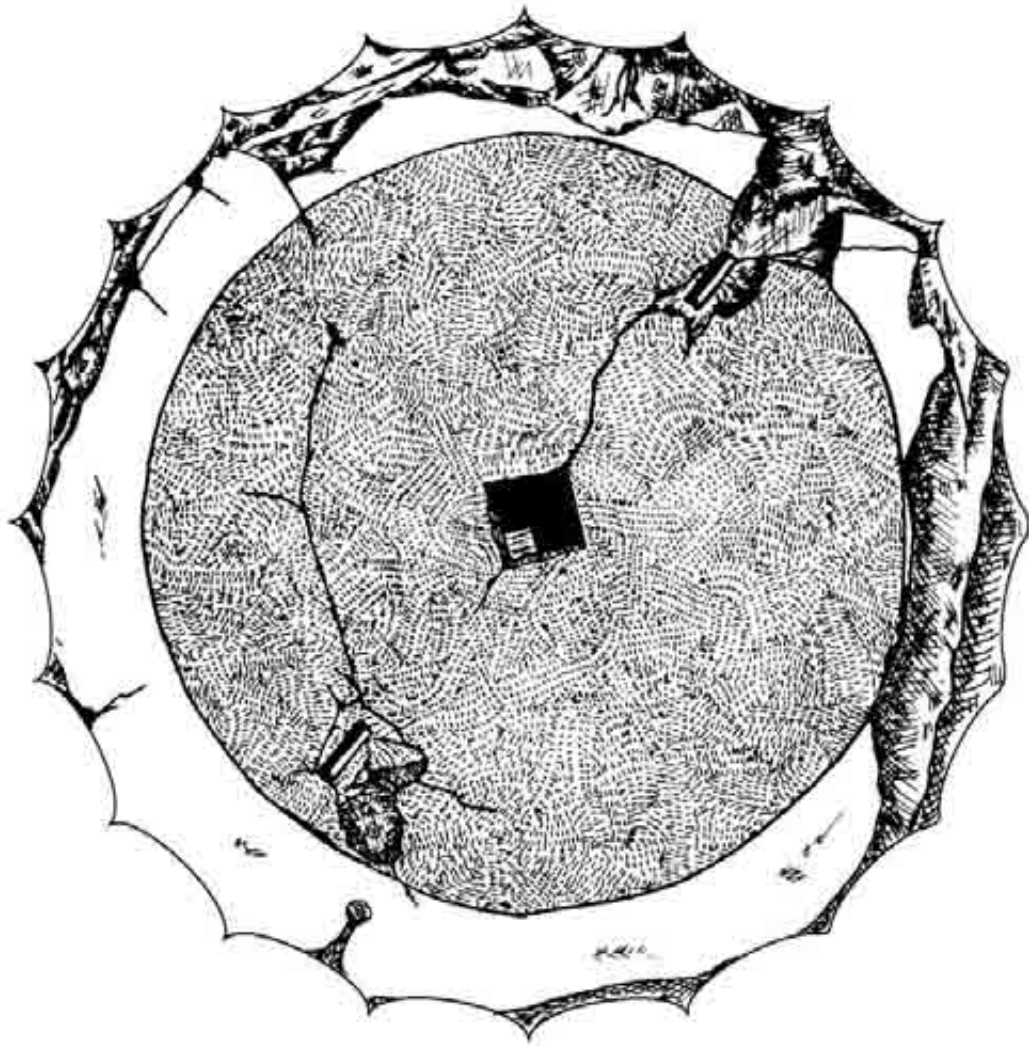

Fig. 21. Upper surface of block 35. Scale 1:10.

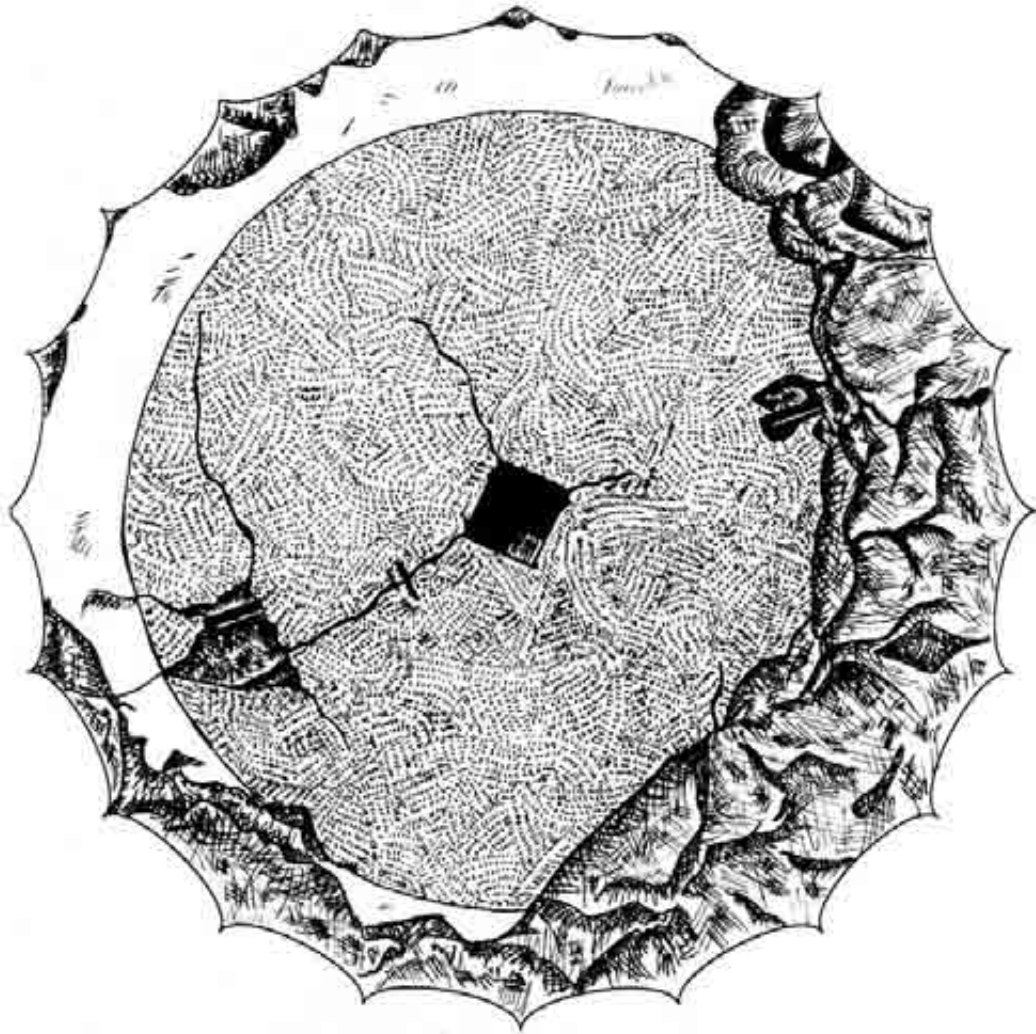

Fig. 22. Upper surface of block 115. Scale 1:10.

whole column height with the capital is 9.544–9.580 m.³²

3. The Shaft Profile

As we saw in the previous section, the height of the column shaft can be quite accurately determined. Another important feature of the shaft, entasis, is discussed in the following sections.

A. Possible Combinations of the Column Drums

During the documentation project of the drums an error margin particular to each measurement was determined.³³ When the computer program which combines the drums according to diameter measurements and measurement margins is run with the new data as input, the result is quite similar to a run using Clemmensen's data: the histogram of the possible column shaft combinations for the old data is presented in Figure 1 and for the new data in Figure 23.³⁴ The distribution in the latter is more clearly trimodal with one main and two subsidiary modes. The peak of the main mode is at 8.77–8.81 m, at a slightly lower height than Clemmensen's first cluster of 8.80–8.85 m, but the second peaks coincide at 8.95–8.98 m. The second peak—shaded darker than the rest of the distribution—also corresponds to the shaft height defined in the previous section. Due to more measured drums and to some wider measurement margins, the number of possible combinations has exploded from 3,361 to 27,516. The number of possible shaft combinations within the range 8.952–8.977 m is 1,678.

B. Shaft Profiles and Maximum Entasis

Measurement accuracy is an important factor in determining which of the possible drum combinations constitute acceptable shaft profiles. The average accuracy of

³² Independently of the statistical confidence interval of the mean shaft height, I have argued for a column height of 9.56–9.58 m based on the cella wall; however, there is no question that the height analysis presented here is a better solution to the problem and should be preferred over the analysis in Pakkanen 1996b, 163–164. Moreover, it is very probable that an analysis of the cella wall height will not make it possible to define the temple height any more accurately than on the basis of the column height; even if it is possible to determine the sequence of cella wall blocks of different heights with certainty, the variation in the heights of the courses easily amounts to three or four centimetres.

³³ See p. 12, esp. n. 6.

³⁴ On the computer program, see p. 2 and App. E, p. E2; for a discussion of Fig. 1, see pp. 2–3. Blocks 48 and 93, both *A* drums, are omitted from the possible shaft combinations because their lower diameter can only be estimated.

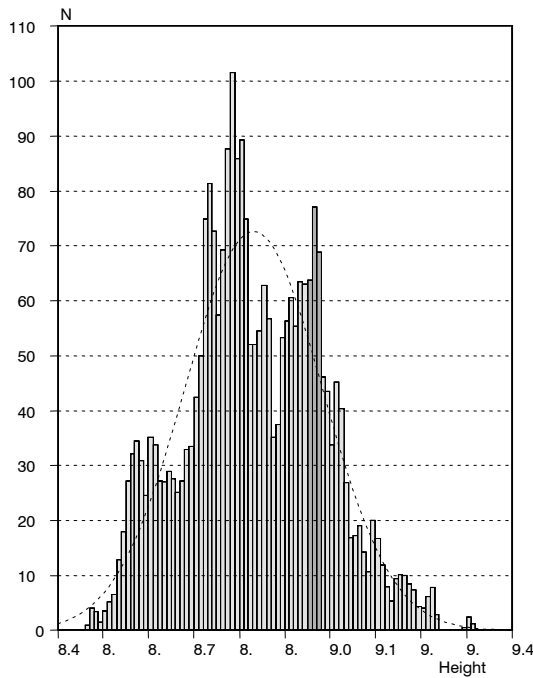

Fig. 23. Histogram of possible shaft height combinations: $N = 27,516$. Based on new measurements.

the column drum diameter measurements at Tegea is ± 2.9 mm (for the measurement ranges, see Appendix A). In the profile analysis the radii of the drums are used rather than the diameters, so the level of accuracy must also be halved: for a measurement margin of ± 2.9 mm the parameter of accuracy can be input as ± 1.5 mm to the computer program used in the analysis.

It is possible to determine which of the drum combinations at Tegea produce a consistent shaft profile within the measurement accuracy by employing a computer program³⁵ which defines two boundary lines for each combination: all the points of the shaft profile should fall within these two lines to be accepted as a possible solution. Figure 24 presents an acceptable drum combination: all the small circles representing the shaft co-ordinates are within the zone defined by the dotted lines. Figure 25 shows an unacceptable profile where the point at the joint of the first and the second drum falls outside the zone.

The curves of the boundary lines are parabolas, and their position is defined by the measurement accuracy parameter and the position of the maximum entasis input to the computer program. The curve on the left is 1.5 mm to the left of the “ideal” shaft profile, and that on the right is the same amount to the right (see Figs. 24 and 25). The width of the complete zone is in this case ± 1.5 mm.

For the starting point of the analysis, a data-file including the shaft co-ordinates of the 1,678 possible shaft combinations within the shaft height range of 8.952–8.977 m was created. The computer program was run with different parameters for the height of maximum entasis (at 40–60% of the shaft height) and

³⁵ See App. E, pp. E2–3; on the use of the same computer program in connection with Labraunda, see Pakkanen 1998.

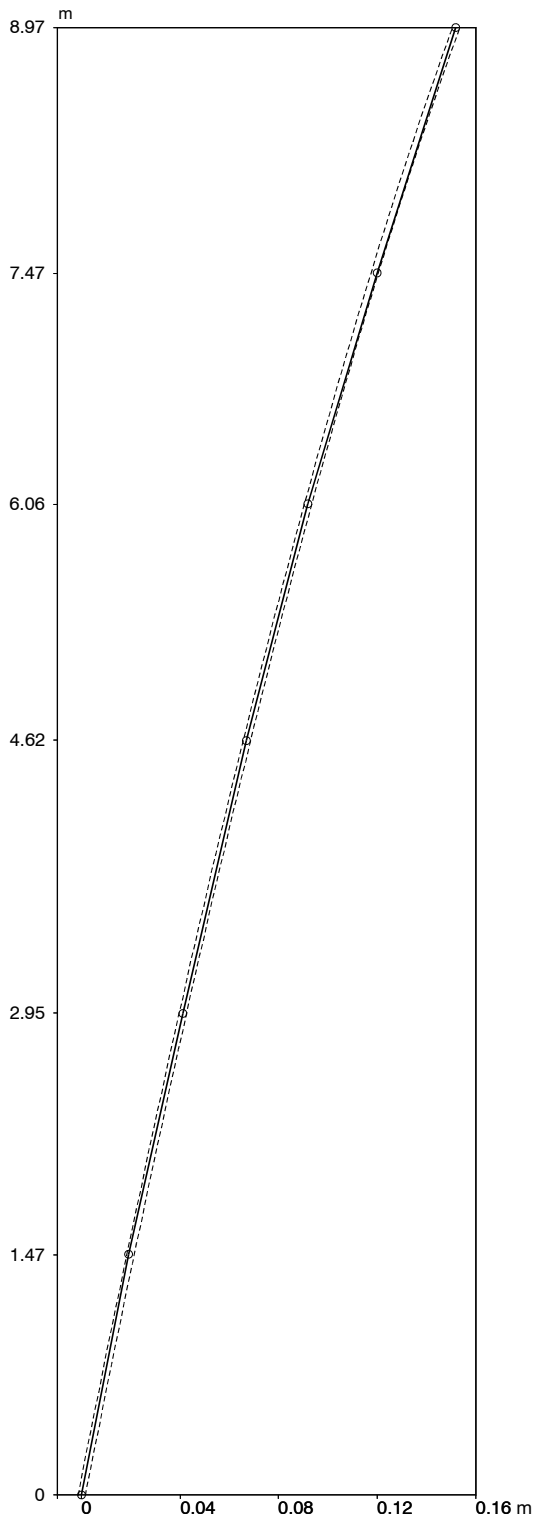

Fig. 24. Example of acceptable shaft profile.

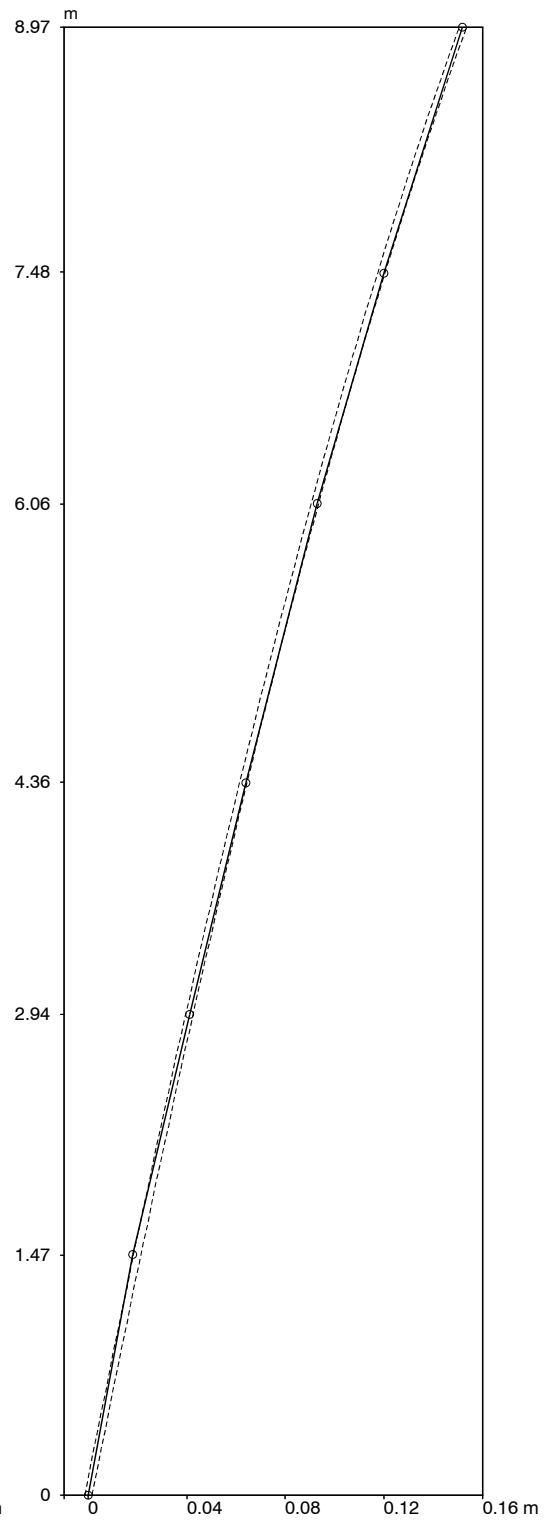

Fig. 25. Example of unacceptable shaft profile.

Table 9. Frequencies of accepted shaft profiles.

	13 mm	12 mm	11 mm	10 mm	9 mm
0.60	42	88	137	82	66
0.59	42	87	119	81	62
0.58	42	88	113	79	61
0.57	42	88	111	77	62
0.56	40	88	116	77	62
0.55	37	89	126	79	62
0.54	35	89	139	81	61
0.53	25	87	149	82	61
0.52	23	81	150	82	65
0.51	18	84	151	79	66
0.50	20	77	152	69	65
0.49	20	68	146	70	63
0.48	20	70	144	82	66
0.47	19	66	130	84	42
0.46	10	61	127	89	31
0.45	11	50	114	83	38
0.44	11	43	93	88	44
0.43	8	25	90	98	47
0.42	8	19	87	96	59
0.41	5	20	81	148	59
0.40	4	13	70	152	80

The top row gives the amount of maximum entasis and the left column the proportional height of maximum entasis.

the amount of maximum entasis (9–13 mm). The values of these parameters were based on preliminary analysis and architectural comparanda: Varying the amount of maximum entasis, there are very few acceptable shaft profiles below 9 mm and above 13 mm. In Late Classical Doric architecture in the Peloponnese and at Delphi the position of maximum entasis is invariably approximately in the middle of the shaft.³⁶ All the 1,678 shaft profiles were tested, for all the different combinations of input parameters, for whether they produce an acceptable within the measurement accuracy or not: the frequencies are summarised in Table 9. The darker the background colour, the more acceptable shafts there are in the class. For example, with the amount of maximum entasis set as 12 mm and the height of entasis as 0.46, of the 1,678 possibilities 61 fall within the zone of conceivable profiles.

There are two clusters with high frequency of acceptable shaft profiles: the first one has a maximum entasis of 11 mm at the height of 48–53% of the complete shaft and the second has a maximum entasis of 10 mm at 40–41% of the shaft. Comparative material would suggest that the first cluster is the more probable position of maximum entasis,³⁷ and this is confirmed by calculating the means of the *x* and *y* co-ordinates of the 1,678 possible shaft profiles: the amount of maximum entasis of the mean profile is 11 mm at 48% of the shaft height. This

³⁶ At 48–56% of the shaft height (Pakkanen 1997, 342, table 3).

³⁷ See n. 36 above.

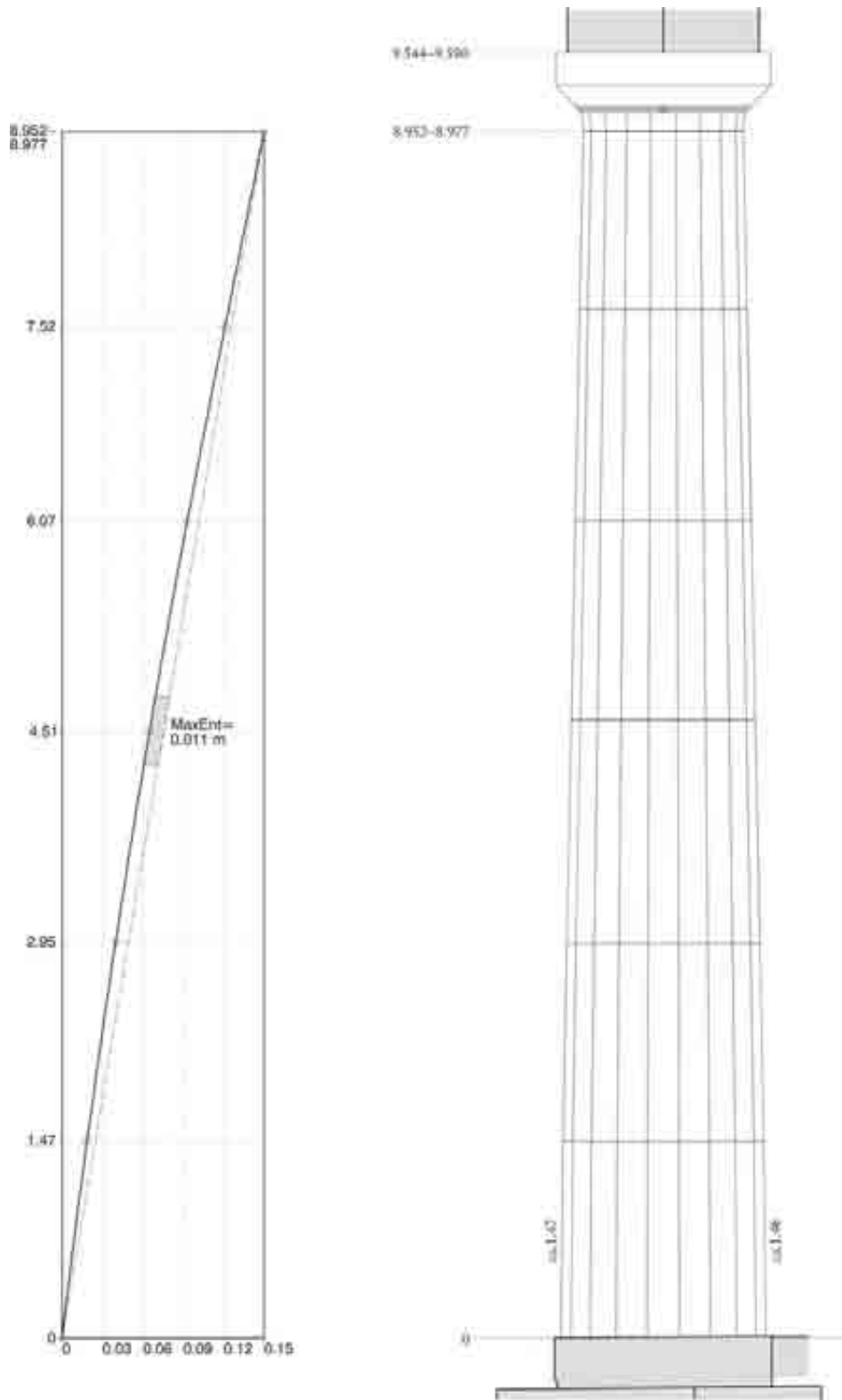

Fig. 26. Shaft profile with exaggerated x axis (left); reconstruction of the peristyle column (right; scale 1:50).

shaft profile is presented in Figure 26; the change in the direction of the entasis curve is minimal in the middle of the shaft, such that it is preferable to give the height of the maximum entasis as within the range 48–53% rather than selecting a single value for it.³⁸ The right part of Figure 27 shows a reconstruction of the peristyle column at Tegea.

4. Shaft Design

A. Foot Unit

I have intentionally refrained from making any references to ancient foot units in the previous analysis: the measurement ranges have been determined using statistics and various computer programs. Table 10 displays the main dimensions of the column, and they are compared to a number of foot units proposed by different scholars. H. Bankel has tentatively suggested an ‘Ionic foot’ of 0.294 m, H. Bauer a unit of 0.296 m, Ch. Dugas, M. Clemmensen, and W. Koenigs a unit of 0.2985 m, and finally W. B. Dinsmoor a ‘Doric foot’ of 0.326 m.³⁹

Table 10. Dimensions expressed in different foot units and their discrepancies.

<i>M</i>	<i>Min</i>	<i>Max</i>	<i>Bankel</i>	<i>Discr</i>	<i>Bauer</i>	<i>Discr</i>	<i>Dugas</i>	<i>Discr</i>	<i>Dinsm</i>	<i>Discr</i>	0.3065	<i>Discr</i>
Diam _{LA}	1.545	1.554	5'4"	-0.001	5'4"	-	5'3"	-	4'12"	-	5'1"	-
Diam _{UA}	1.196	1.213	4'2"	-	4'1"	-	4'1"	-	3'11"	-	3'15"	-
ColH	9.544	9.580	32'8"	-	32'4"	-	32'0"	-	29'6"	-	31'4"	-
ShaftH	8.952	8.977	30'8"	-	30'4"	-	30'0"	-	27'8"	-	29'4"	-
CapH	0.592	0.603	2'1"	0.003	2'0"	-	2'0"	-	1'13"	-0.001	1'15"	-
AbW	1.609	1.616	5'8"	0.001	5'7"	-	5'6"	-0.005	4'15"	-	5'4"	-

If the measurement expressed as feet and dactyls falls within the measurement range, no discrepancy is reported, and if it does not, the distance to the closest limit is reported as the discrepancy: for example, a discrepancy of -0.001 m in Bankel’s lower shaft diameter means that 5'4" (≈ 1.544 m) is actually 0.001 m below the lower limit of the measurement range. As we see, the different foot measures generally fit very well within the established ranges, and even though there are no discrepancies with Bauer’s foot unit of 0.296 m, I would hesitate to prefer it to the others because of the very small discrepancies observable in the other proposals. It is actually possible to find a number of completely hypothetical ‘foot units’ that fit to the ranges without any discrepancies; in Table 10 a unit of 0.3065 m is given as an example. However, it is interesting that the column and shaft

³⁸ The plotted points in Fig. 26 are (0,0), (0.018,1.471), (0.040,2.947), (0.065,4.502), (0.093,6.072), (0.121,7.523), (0.150,8.964), and the formula of the fitted curve is $y = 0.005 + 82.3x - 235.5x^2 + 562.4x^3$.

³⁹ Bankel 1984, 415; Bauer 1973, 69; Dugas *et al.* 1924, 59; Clemmensen 1924, 10; Koenigs 1977, 231–233; Dinsmoor 1950, 195 n. 1, 219.

heights can be expressed in feet and simple fractions of a foot in four of the systems: the column height could be $32\frac{1}{2}$ and the shaft height $30\frac{1}{2}$ 'Ionic feet' of 0.294 m, or $32\frac{1}{4}$ and $30\frac{1}{4}$ Bauer's foot units of 0.296 m, or 32 and 30 Dugas' foot units of 0.2985 m, or $31\frac{1}{4}$ and $29\frac{1}{4}$ feet of 0.3065 m. In conclusion, it seems that no decision on the ancient foot unit used in the design of the temple of Athena Alea at Tegea can be made on the basis of the column measurements.

B. Drum heights

It was recently suggested to me by M. Korres that one possible explanation for the differing heights of the *C*, *D*, *E*, and *F* drums could be that the *C* and *D* drums on the one hand, and the *E* and *F* drums on the other hand, were designed as pairs so that the height of the joint of *D* and *E* drums was constant. This suggestion, however, does not seem to be supported by the possible drum combinations with the known pairs of matching drums. In the shafts comprising the matching *C* drum 9 and *D* drum 7 the top surface of the *D* drum is at a height of 6.12–6.14 m, and in the shafts with matching *D* drum 35 and *E* drum 115 the joint between the drums is at a height of 5.91–6.07 m.⁴⁰ Since these ranges do not overlap, the placing of the tall and short drums within the shaft appears not to have been systematic.

C. Entasis Design

I have discussed entasis in fourth-century BC Doric buildings in the Peloponnese and at Delphi in a recent article:⁴¹ the data presented in Table 11 conforms well to the conclusions of that text. On the basis of the figures in Table 11 it is possible to evaluate how well the conic sections—circle, ellipse, parabola and hyperbola—fit to the shaft profile measurements.⁴² The residual sum of squares is calculated by squaring the differences between the *y* co-ordinates and the predicted values of *y* and then adding these together. On the basis of the mean of the absolute discrepancies it is possible to evaluate the accuracy of the estimated curve: for example, with the circle formula the measured heights are on average at a distance of 26 mm from the calculated shaft profile *y* co-ordinates.

All the different conic sections fit to the shaft profile data very accurately. If Skopas used a conic section in the design of the shaft profile, it is reasonable to suggest that he would have employed a circle or an ellipse, as they are easier to

⁴⁰ The number of shaft combinations within the height range 8.952–8.977 m for the matching *C* and *D* drums is 97, and for the matching *D* and *E* drums it is 18.

⁴¹ Pakkanen 1997.

⁴² For the co-ordinates of the fitted shaft profile, see n. 38 above. On curve fitting and entasis in general, see Pakkanen 1997, 336–341.

Table 11. Mathematical formulae and their fit to points of the Tegea shaft profile.

Building and fitted formula	Residual sum of squares	Mean of absolute discrepancies (m)
Circle: $(x - x_0)^2 + (y - y_0)^2 = r^2$ $x_0 = 947.328$ (0.009), $y_0 = -11.461$ (0.059), $r = 947.328$ (0.009)	0.0102	0.030
Ellipse: $\frac{(x - x_0)^2}{a^2} + \frac{(y - y_0)^2}{b^2} = 1$ $x_0 = 2.983$ (-), $y_0 = -12.868$ (0.952), $a = 3.0606$ (0.0075), $b = 57.604$ (1.714)	0.0040	0.023
Parabola: $(y - y_0)^2 = a \times (x - x_0)$ $x_0 = -0.06948$ (0.00613), $y_0 = -11.4564$ (0.7467), $a = 1893.99$ (88.44)	0.0034	0.021
Hyperbola: $\frac{(x - x_0)^2}{a^2} - \frac{(y - y_0)^2}{b^2} = 1$ $x_0 = 0.7700$ (-), $y_0 = -7.7277$ (0.3579), $a = 0.7235$ (0.0034), $b = 21.227$ (0.214)	0.0025	0.015

The standard errors of the estimated parameters are given in the parentheses.⁴³

use than a parabola or a hyperbola. In the following I will present two possibilities for how the architect could have designed the gently curving profile.

Producing a scale drawing of a polygon approximating an arc of an ellipse is quite simple.⁴⁴ All that is required are a ruler with dactyl markings and a drawing surface of ca. 0.20 × 0.60 m. Let us hypothetically suppose that Skopas was using Dugas' foot unit of 0.2985 m in the design: the shaft height expressed in feet would in that case be 30 feet, and the taper of the profile half a foot or eight dactyls.⁴⁵ I am intentionally using here values calculated from the shaft diameters measured between the flutes and not the arrises, because this makes it possible to compare the measurements derived from the drawing with dimensions of the shaft profile: I am not suggesting that the architect actually designed the profile of the flute bottom instead of the arris.

In the scale drawing the width of the area, eight dactyls, is marked at full scale, but the height is scaled down: one dactyl corresponds to one foot and the height of the drawing is 30 dactyls. If the architect is of the opinion that dividing

⁴³ No standard error is given for parameter x_0 of the ellipse and the hyperbola because it is given as input to the program which estimates the other parameters; see Pakkanen 1997, 338 n. 79.

⁴⁴ I wish to thank M. Korres for several discussions on curvature design: I have greatly benefited from his insights. Even though no Late Classical scale drawings are known, there is a mid-third-century drawing of a shaft profile on the cella wall of the Ionic temple of Apollo at Didyma; see Haselberger 1983, 115–121.

⁴⁵ The lower diameter of the shaft between flutes expressed in Dugas' feet is 4'14" and the upper diameter 3'14"; the difference, 16", must be halved in order to get the taper of the profile, 8".

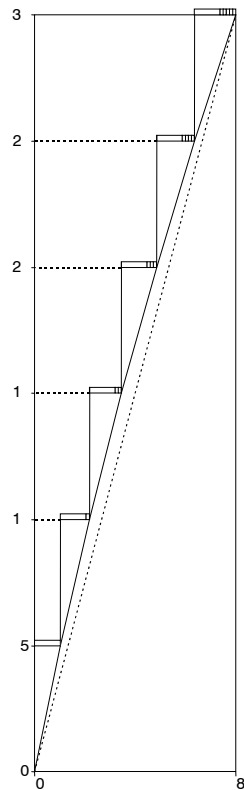

Fig. 27. Hypothetical design drawing of the shaft profile. Dimensions in dactyls.

the shaft height into six equal parts—six is also the number of drums in the shaft—is enough, the ruler must have one of the dactyl markings divided into eight equal parts. The method of drawing the polygon is illustrated in Figure 27. The first point is marked at five dactyls above the base line and one dactyl to the right of the vertical line. From this point another vertical line is drawn to ten dactyls and the next point is marked one dactyl and one subdivision to the right of the new vertical. Again, a new vertical is drawn from this point, but at 15 dactyls the offset to the right is now one dactyl and two subdivisions. At 20 dactyls the offset is increased to one dactyl and three subdivisions, and at 25 dactyls the offset is one dactyl and four subdivisions; at 30 dactyls, or at the top of the drawing, the new point set at one dactyl and five subdivisions to the right of the previous point is very nearly eight dactyls to the right of the first vertical line (the discrepancy is 2 mm). After the marked points are connected, the amount of shaft taper can be measured from the drawing for any given height. No difficult calculations are necessary at any stage of the method.⁴⁶

The discrepancies between the x co-ordinates of the above presented

⁴⁶ Anyhow, it is possible to derive a formula for determining the x co-ordinates of the polygon when y is divided into k equal parts:

$$x(0) = 0; x(1) = d; \text{ for } \frac{k}{2} x(n) = nd + m(n) \times d / a, \text{ where } m(n) = \sum_{i=1}^{n-1} i \text{ and, in this case, } d = 1 \text{ dactyl}$$

and $a = 8$.

Table 12. Comparison of different methods of deriving the x co-ordinates of the shaft profile (m).⁴⁷

<i>Shaft height</i>	<i>Design drawing</i>	<i>Estimated circle</i>	<i>Unit of 0.3065 m</i>
5 ft.	0.019	0.019	0.019
10 ft.	0.040	0.041	0.041
15 ft.	0.063	0.065	0.065
20 ft.	0.089	0.091	0.091
25 ft.	0.117	0.120	0.120
30 ft.	0.147	0.151	0.151

graphical method and the true circle fitted to the measurement data are small but noticeable (Table 12).⁴⁸ If in the design drawing a ‘foot unit’ of 0.3065 m is used for the width of the drawing instead of Dugas’ foot unit of 0.2985 m, there are no differences between the fitted circle and the graphical method.

The method is also very flexible. Reducing the number of dactyl subdivisions increases the amount of maximum entasis: for example, dividing the dactyl into five equal parts instead of eight would have increased the entasis from 11 mm to 17 mm (and at the same time the drawing is widened from eight to nine dactyls). With some test drawings the architect could quickly have discovered the desired combination of shaft profile and taper.

The only drawback with the method is that a division of a dactyl into small equal parts is necessary, but, in fact, there is no indication in literary sources or inscriptions that Greek builders ever used any fractions of a dactyl less than a half.⁴⁹ On the other hand, if small fractions of a dactyl were used, it is precisely for the entasis design that they would have been required.

The second alternative design method presented here is quite different from the method of drawing described above. The required space is much larger, ca. 4.5×1.5 m; the equipment required is a ruler and a long string for drawing the arc of the circle. Figure 28 presents a solution based on drawing a true circle. I will again discuss the drawing in terms of Dugas’ foot unit. The centre of the circle is drawn one and a half times the height of the drawing, 45 dactyls, below the base line; the radius of the circle is half of the shaft height, or 15 feet. The right part of Figure 28 shows the drawing of the shaft profile at larger scale. The arc of the circle fits fairly accurately to the points of the first drawing method; these points are plotted as small circles in Figure 28. The amount of maximum entasis is 9 mm, slightly less than the determined entasis at Tegea of 11 mm. The architect could have increased the amount of entasis by bringing the centre of the circle slightly closer to the drawing area. The method is extremely simple, and, with a little testing, both the taper and entasis of the shaft can be controlled. Transforming the design to full scale, the realised shaft profile becomes an elliptical arc.

⁴⁷ The figures for ‘*Design drawing*’ and ‘*Unit of 0.3065 m*’ are calculated using the formula of n. 46 above. In the former $d = 0.2985 \text{ m} / 16$, and in the latter $d = 0.3065 \text{ m} / 16$.

⁴⁸ For the circle formula and the used estimated parameters, see Table 11.

⁴⁹ Coulton 1975, 92–93.

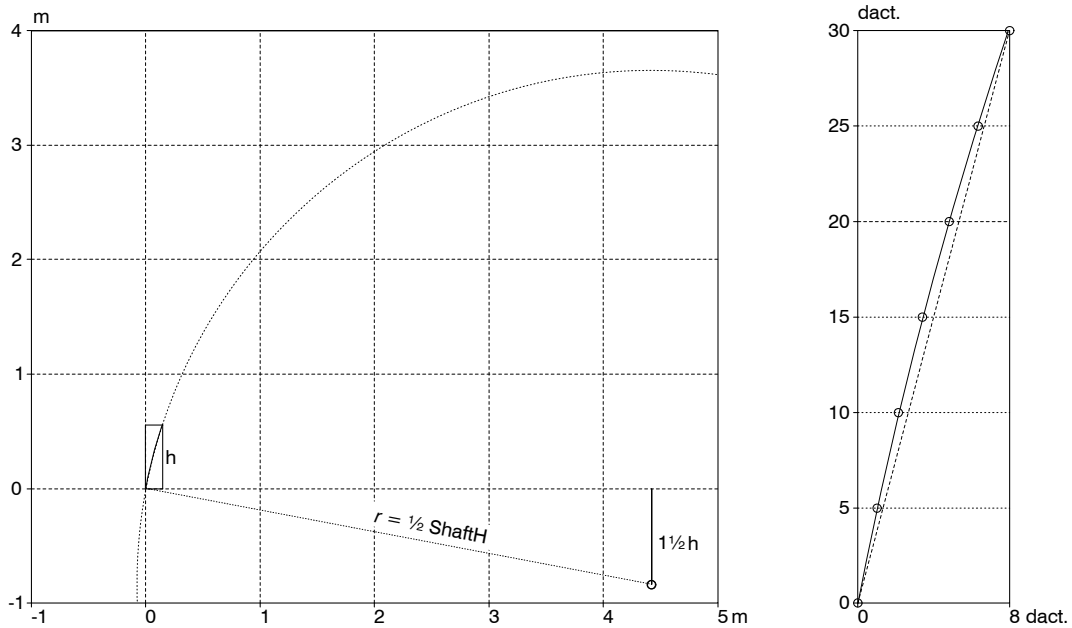

Figure 28. Hypothetical design drawing of the shaft profile (large circle).

In conclusion, both of the methods could easily have been employed by the ancient architect. I find the latter method slightly more attractive because of its simplicity; it also avoids the problem of using subdivisions of a dactyl. Therefore, I suggest that the shaft profile at Tegea was quite likely to have been designed using the circle method.

5. Column Proportions

With the column height and shaft profile of the temple of Athena Alea quite accurately determined it is possible compare the column proportions of different Doric buildings in the Peloponnese and Central Greece (Table 13). The slight modification in the column height at Tegea does not significantly alter the proportion

$\frac{\text{column height}}{\text{lower diameter between the arrises}}$: there is a trend, even if it is not very clear, to make

the column more slender during the fourth century. The columns of the two tholoi at Delphi and at Epidauros, and the treasury at Delphi are proportionally significantly taller than the columns of the other buildings (column A).⁵⁰

On the other hand no chronological trends can be observed in the taper of column (column B) or the proportional flute depths (columns C and D). The

⁵⁰ The columns of the tholoi are probably more slender in order to balance their proportionally greater width; see Roux 1961, 321 and Tomlinson 1983, 64.

Table 13. Column proportions (late 5th – late 4th century BC).

	A.	B.	C.	D.	E.	F.
Bassai, t. of Apollo (not frontal)	5.359	3.88–3.91	0.205	0.168	–	–
Argive Heraion, second t. of Hera	5.4–5.7 ⁵¹	4.3–4.5	0.20	0.15	<i>exists</i>	
Delphi, tholos	6.83	3.53	0.206	0.138	0.09	0.53
Delphi, 4th cent. t. Apollo	5.44	3.69		0.226	<i>exists</i>	
Delphi, 4th cent. t. Athena	5.91	3.41	0.268	0.248	0.08	0.52
Epidauros, tholos (11/12 drums)	6.9 / 7.5	3.5 / 3.5	0.17	0.13	0.15 / 0.14	0.48–0.52
Tegea, t. of Athena Alea	6.16–6.18	3.79–3.80	0.19	0.16	0.12	0.48–0.53
Delphi, treasury of Kyrene	6.94	2.69			0.22	0.56
Nemea, t. of Zeus	6.342	3.33	0.216	0.152	0.14 ⁵²	0.51 ⁵²
Stratos, t. of Zeus	6.0?	4.2?	0.22	0.13		

A. Proportional height of the column = $\text{ColH} / \text{Diam}_{\text{LA}}$

B. Taper of column shaft (%) = $100 \times (\text{Diam}_{\text{LA}} - \text{Diam}_{\text{UA}}) / \text{ShaftH}$

C. Proportional flute depth at the bottom of the shaft = $[(\text{Diam}_{\text{LA}} - \text{Diam}_{\text{L}}) / 2] / \text{FIW}_{\text{L}}$

D. Proportional flute depth at the top of the shaft = $[(\text{Diam}_{\text{UA}} - \text{Diam}_{\text{U}}) / 2] / \text{FIW}_{\text{U}}$

E. Proportional emphasis of maximum entasis (%) = $100 \times \text{Ent}_{\text{max}} / \text{ShaftH}$

F. Proportional position of maximum entasis in the shaft = $\text{EntH} / \text{ShaftH}$

fluting is always more shallow at the top of the shaft than at the bottom. The proportional emphasis of the maximum entasis varies during the fourth century (column *E*), but it is always placed approximately in the middle of the shaft (column *F*). In the two earlier buildings at Delphi the entasis is less pronounced. The emphasised entasis of the treasury of Kyrene is most likely a feature of ‘Kyrenaian’ Doric order; the building is clearly different in other respects, as well, from mainland Doric style.⁵³

⁵¹ Based on the preserved 14 column drums at the Heraion the bootstrap-*t* 95% confidence interval for the mean can be calculated as 0.825–0.865 m; the height of the column shaft cannot be determined any more accurately than as 6.60–6.92 m and the column height with the capital as 7.10–7.43 m (C. Pfaff’s proposal of 7.32 m for the column height cannot be sustained); for the drum heights at the Heraion, see Pfaff 1992, 123, pls. 116–123.

⁵² Calculated for the pronaos column.

⁵³ See Pakkanen 1997, 332–334.

VII. Conclusions

This study partially presents the results of the documentation project on the blocks of the fourth century BC temple of Athena Alea at Tegea obtained from 1993–1998; the building block documentation is directly connected with the five year Norwegian excavation project (1990–1994) in the sanctuary led by E. Østby.

The 49 column drums preserving their full height and both the lower and upper diameters were documented on zone sheets: each peristyle column of the temple had consisted of six drums and, correspondingly, the shaft was divided into six overlapping parts which take the entasis of the shaft into consideration. The measurements were recorded and the positions of the empolion cutting and the dowels drawn on the zone sheets. Once the documentation was complete it became possible to identify the blocks with the drums numbered by Ch. Dugas and M. Clemmensen and published in 1924. The previous measurements were discovered to be generally reliable.

The lower diameter of the bottom drums between the flutes is 1.45–1.46 m and between the arrises ca. 1.55 m. The corresponding measurements for the top of the shaft are 1.15–1.16 m and 1.20–1.21 m. The corner columns were not thickened. The peristyle columns were standing vertical: the height variation of the bottom drums is not enough to incline the columns towards the interior—as the previous reconstruction shows—but only to correct the horizontal curvature of the stylobate. All the drums used in the study can be shown to be from the peristyle order.

The variation of the capital dimensions, even though small, creates difficulties in the analysis of architectural proportions—individual capitals at Tegea could be placed on the basis of proportions almost anywhere in the chronological list of fourth century buildings. The Tegea capitals support the conclusions reached by J. J. Coulton in his study on Doric capitals (1979): 1) the homogeneity of the fourth century capitals is most likely a result of the use of proportional rules, and 2) the use of proportions to date buildings should be reconsidered.

The horizontal curvature of the foundations has been restudied: the central part of the south flank was measured to be 0.080 m higher than the south-east corner of the foundations, and the height difference on the west short side is 0.054 m. The entablature has been shown to have horizontal curvature as well. Nine of the twelve entablature blocks show signs of being adjusted for horizontal curvature: the range of the angle measurements is 89.7–90.8°.

The height of the column can be most reliably determined using computer-intensive statistics: the bootstrap-*t* method is able to deal with the non-random and non-normal drum height distribution. The validity of the method was confirmed by Monte Carlo simulation. Non-randomness of the data is shown to cause a conservative estimate of the shaft height, so the bootstrap-*t* method can be used to calculate the confidence interval of the shaft height. On the basis of matching pairs of drums the shaft height can be defined as 8.952–8.977 m at a confidence level of 95%; the column height with the capital is 9.544–9.580 m. This is 0.070–0.106 m higher than the previous reconstruction of 9.474 m, but perhaps even more significant than the definition of a new height is that millimetre exact reconstruction of the peristyle column at Tegea cannot be reached with the currently preserved material.

The number of possible drum combinations within the defined height range is 1,678. By determining which of the combinations produce an acceptable shaft profile within the measurement accuracy the amount of maximum entasis of is defined as 11 mm and the height of maximum projection as 48–53% of the shaft height.

It is demonstrated that all the foot units suggested by different scholars fit equally well to the column dimensions. Therefore, no decision can be made on the ancient foot unit used in the design of the temple on the basis of these measurements. Two alternative methods for designing the entasis curve are discussed; both are simple graphical methods which do not require any calculations. The second solution, based on a scale drawing and sketching a circle of approximately half the shaft height in radius, is proposed as the design method employed at Tegea.

The method for analysing the column height and shaft profile developed in this study can, with slight modifications, be applied elsewhere where there is enough architectural material preserved but the height of the building is not known. It is important to conduct the documentation so that individual margins can be determined for all the key measurements of the column drums—only data of this type can be used as input for the computer programs used in the analysis.

Sources and Literature

Bibliographical Abbreviations

AA	<i>Archäologischer Anzeiger</i>
ADelt	<i>Ἀρχαιολογικὸν Δελτίον</i>
AJA	<i>American Journal of Archaeology</i>
AM	<i>Mitteilungen des Deutschen Archäologischen Instituts, Athenische Abteilung</i>
BEFAR	Bibliothèque des Écoles françaises d'Athènes et de Rome
BCH	<i>Bulletin de correspondance hellénique</i>
BSA	<i>Annual of the British School at Athens</i>
CJS	<i>Canadian Journal of Statistics</i>
CRAI	<i>Comptes rendus. Académie des inscriptions & belles-lettres</i>
Délos	Exploration archéologique de Délos faite par l'École française d'Athènes
FdD	Fouilles de Delphes
<i>Hesperia</i>	<i>Hesperia. Journal of the American School of Classical Studies at Athens</i>
<i>IstMitt</i>	<i>Istanbuler Mitteilungen</i>
JAS	<i>Journal of Archaeological Science</i>
JdI	<i>Jahrbuch des Deutschen Archäologischen Instituts</i>
OpAth	<i>Opuscula Atheniensi</i>
Prakt	<i>Πρακτικά τῆς ἐν Ἀθήναις Ἀρχαιολογικῆς Ἐταιρείας</i>

Sources

IG *Inscriptiones Graecae*. Berolini 1873–.

PAUSANIAS

Pausanias. Description of Greece, vol. IV. Transl. by W.H.S. Jones. The Loeb Classical Library 1935 (1955). London.

Pausaniae Graeciae Descriptio, vol. II. Ed. M.H. Rocha-Pereira. Bibliotheca Scriptorum Graecorum et Romanorum Teubneriana. Leipzig 1977.

VITRUVIUS

Vitruvius. De architectura libri I-V, vol. I. Ed. and transl. by F. Granger. The Loeb Classical Library 1931 (1983). London.

Literature

ADLER, F.—BORRMANN, R.—DÖRPFELD, W.—GRAEBER, F.—GRAEF, P.
1892 *Die Baudenkmäler von Olympia*. Olympia II. Berlin.

AMANDRY, P.—BOUSQUET, J.

1940–41 'La colonne dorique de la Tholos de Marmaria,' *BCH* 64–65, 121–127.

BALANOS, N. M.

1938 *Les Monuments de l'Acropole. Relèvement et conservation*. Paris.

BANKEL, H.

1984 'Moduli an den Tempeln von Tegea und Stratos? Grenzen der Fussmassbestimmung,' *AA*, 413–430.

BAUER, H.

1973 *Korinthische Kapitelle des 4. und 3. Jahrhunderts v. Chr.* *AM* Beiheft 3. Berlin.

- BOUSQUET, J.
1952 *Le Trésor de Cyrène*. FdD. Paris.
- BUNDGAARD, J. A.
1957 *Mnesicles. A Greek Architect at Work*. København.
- BURFORD, A.
1969 *The Greek Temple Builders at Epidauros*. Toronto.
- CHARBONNEAUX, J.—GOTTLOB, K.
1925 *La Tholos du sanctuaire d'Athéna Pronaia à Delphes*. FdD. Le Sanctuaire d'Athéna Pronaia (Marmaria). Paris.
- CHRISTOU, CH.—DEMAKOPOULOU, A.
1965 'Έργασίαι εις χώρον ναοῦ Ἀλέας Αθηγὰς ἐν Τεγέα,' *ADelt* 20.2.1: Χρονικά, 169–170.
- CLEMMENSEN, M.
1925 'Le temple de Zeus à Nemée,' *BCH* 49, 1–12.
- COOPER, F. A.—SMITH, C.
1983 'The Reconstruction Project: 1980–1983,' in *Temple of Zeus at Nemea. Perspectives and Prospects*, 50–79. A Guide to the Exhibition, Benaki Museum. [Athens.]
- COOPER, F. A.
1988 'The Temple of Zeus at Nemea and Architectural Refinements of the Fourth Century B.C.,' in Πρακτικά του XII διεθνούς συνεδρίου κλασικής αρχαιολογίας [Proceedings of the 12th International Congress of Classical Archaeology] 4–10 Σεπτεμβρίου 1983, 37–40. Αθήνα.
- COOPER, F. A.
1992 *The Temple of Apollo Bassitas IV*. Princeton, N.J.
- COOPER, F. A.
1996 *The Architecture. The Temple of Apollo Bassitas I*. Princeton, N.J.
- COULTON, J. J.
1975 'Towards Understanding Greek Temple Design: General Considerations,' *BSA* 70, 59–99. Corrigenda in *BSA* 71, 1976, 148–149.
- COULTON, J. J.
1977 *Ancient Greek Architects at Work. Problems of Structure and Design*. New York.
- COULTON, J. J.
1979 'Doric Capitals: a Proportional Analysis,' *BSA* 74, 81–153.
- COURBY, F.—PICARD, CH.
1924 *Recherches archéologiques à Stratos d'Acarnanie*. Paris.
- COURBY, F.
1927 *La terrasse du temple*. FdD. Paris
- COURBY, F.
1931 *Les temples d'Apollon*. Délos XII. Paris.
- DEMAKOPOULOU, A.
1966 'Ἀνασκαφή εις Τεγέαν,' *ADelt* 21.2.1: Χρονικά, 152–154.
- DEMANGEL, R.
1923 *Les temples de tuf*. FdD. Le Sanctuaire d'Athéna Pronaia (Marmaria). Paris.
- DINSMOOR, W. B.
1950³ (1985) *The Architecture of Ancient Greece. An Account of its Historic Development*. London.
- DODWELL, E.
1819 *A Classical and Topographical Tour through Greece during the Years 1801, 1805, and 1806 II*. London.
- DÖRPFELD, W.
1883 'Der Tempel der Athena in Tegea,' *AM* 8, 274–285.
- DUCOUX, H.
1940–41 'Restauration de la façade du temple d'Apollon,' *BCH* 64–65, 266–267.

- DUGAS, CH.
1911 'Les fouilles de Tégée,' *CRAI*, 257–268.
- DUGAS, CH.
1921 'Le sanctuaire d'Aléa Athéna à Tégée avant le IV^e siècle,' *BCH* 45, 335–435.
- DUGAS, CH.—BERCHMANS, J.—CLEMMENSEN, M.
1924 *Le sanctuaire d'Aléa Athéna à Tégée au IV^e siècle*. Paris.
- EDGINTON, E. S.
1995³ *Randomization Tests*. New York.
- EFRON, B.
1981 'Nonparametric standard errors and confidence intervals,' *CJS* 9, 139–172.
- FISHER, P.—FARRELLY, C.—MADDOCKS, A.—RUGGLES, C.
1997 'Spatial Analysis of Visible Areas from the Bronze Age Cairns of Mull,' *JAS* 24, 581–592.
- GARDNER, E. A.—LORING, W.—RICHARDS, G. C.—WOODHOUSE, W. J.—SCHULTZ, R. W.
1892 *Excavations at Megalopolis 1890–1891*. The Society for the Promotion of Hellenic Studies Supplementary Papers I. London.
- GOODYEAR, W. H.
1912 *Greek Refinements. Studies in Temperamental Architecture*. Yale, London, and Oxford.
- HASELBERGER, L.
1983 'Bericht über die Arbeit am Jüngerem Apollontempel von Didyma,' *IstMitt* 33, 90–123.
- HILL, B.H.
1966 *The Temple of Zeus at Nemea*. Revised and supplemented by C.K. Williams, II. Princeton.
- KNELL, H.
1983 'Dorische Ringhallentempel in spät- und nachklassischer Zeit,' *Jdl* 98, 203–233.
- KOENIGS, W.
1979 'Zum Entwurf dorischer Hallen,' *IstMitt* 29, 209–237.
- KORRES, M.—TOGANIDES, N.—ZAMBAS, K.
1989 *Μελέτη Ἀποκαταστάσεως τοῦ Παρθενῶνος, τόμος 2α*. Ἀθήνα.
- KORRES, M.
1993a *Ἀπό την Πεντέλη στον Παρθενώνα*. Ἀθήνα.
- KORRES, M.
1993b 'Refinements of refinements,' manuscript of a paper presented in the *Second Williams Symposium on Classical Architecture* (University of Pennsylvania 1993). Forthcoming in L. Haselberger et al., *Appearance and Essence: Refinements of Classical Architecture—Curvature*.
- LAWRENCE, A. W.—TOMLINSON, R. A.
1996⁵ *Greek Architecture*. The Pelican History of Art. New Haven and London.
- MANLY, B. F. J.
1996 'The Statistical Analysis of Artefacts in Graves: Presence and Absence Data,' *JAS* 23, 473–484.
- MANLY, B. F. J.
1997² *Randomization, Bootstrap and Monte Carlo Methods in Biology*. London, Weinheim, New York, Tokyo, Melbourne, and Madras.
- MARTIN, R.
1965 *Manuel d'architecture grecque I. Matériaux et techniques*. Paris.
- MENDEL, G.
1901 'Fouilles de Tégée,' *BCH* 25, 241–281.
- MICHAUD, J.-P.
1977 *Le temple en calcaire*. FdD. Le Sanctuaire d'Athéna Pronaia (Marmaria). Paris.

- MILCHHÖFER, A.
1880 'Untersuchungsausgrabungen in Tegea,' *AM* 5, 52–69.
- MILES, M. M.
1989 'A Reconstruction of the Temple of Nemesis at Rhamnous,' *Hesperia* 58, 131–249.
- MUSTONEN, S.
1989 *Programming SURVO 84 in C. SURVO84C Contributions* 3, Department of Statistics, University of Helsinki. Helsinki.
- MUSTONEN, S.
1992 *SURVO. An Integrated Environment for Statistical Computing and Related Areas.* Helsinki.
- NEAVE, H. R.
1981 *Elementary Statistics Tables.* London and New York.
- NORDQUIST, G. C.
1995 'Tidiga tempel i Tegea,' *Medusa* 16.2, 26–35.
- NORMAN, N. J.
1984 'The Temple of Athena Alea at Tegea,' *AJA* 88, 169–194.
- ORLANDOS, A.K.
1968 *Les matériaux de construction et la technique architecturale des anciens grecs II.* Paris.
- ØSTBY, E.
1986 'The Archaic Temple of Athena Alea at Tegea,' *OpAth* 16, 75–102.
- ØSTBY, E.
1994 'Recent Excavations in the Sanctuary of Athena Alea at Tegea (1990-93),' in K. A. Sheedy (ed.), *Archaeology in the Peloponnese. New Excavations and Research.* Oxbow Monograph 48. Oxford.
- ØSTBY, E.—LUCE, J.-M.—NORDQUIST, G.C.—TARDITI, C.—VOYATZIS, M.E.
1994 'The Sanctuary of Athena Alea at Tegea: First Preliminary Report (1990–1992),' *OpAth* 20, 89–141.
- PAKKANEN, J.
1996a 'The Entasis of Greek Doric Columns and Curve Fitting: a Case Study on the Peristyle Column of the Temple of Athena Alea at Tegea,' *Archeologia e Calcolatori* 7, 693–702.
- PAKKANEN, J.
1996b 'The Height and Reconstructions of the Interior Corinthian Columns in Greek Classical Buildings,' *Arctos* 30, 139–166.
- PAKKANEN, J.
1997 'Entasis in the Fourth Century BC Doric Buildings in the Peloponnese and at Delphi,' *BSA* 92, 323–344.
- PAKKANEN, J.
1998 "Defining the Possible Column Shaft Height Range and Profile: a Case Study Based on the Temple of Zeus at Labraunda", forthcoming in *OpAth*.
- PALAGIA, O.
1995 'Two Sculptors Named Scopas,' *Newsletter. American School of Classical Studies at Athens* 35, 4.
- PFAFF, C. A.
1992 *The Argive Heraion: the Architecture of the Classical Temple of Hera.* Diss. New York University.
- RANKIN, E.
1986 'Geometry Enlivened: Interpreting the Refinements of the Greek Doric Temple,' *Acta Classica* 29, 29–41.
- RHOMAIOS, K. A.
1909 'Ἀνασκαφαὶ τοῦ Ναοῦ τῆς Ἀλέας,' *Prakt*, 303–316.

- RINGROSE, T. J.
1992 'Bootstrapping and Correspondence Analysis in Archaeology,' *JAS* 19, 615–629.
- ROUX, G.
1961 *L'architecture de l'Argolide aux IV^e et III^e siècles avant J.-C.* BEFAR 199. Paris.
- SHENNAN, S.
1997² *Quantifying Archaeology*. Edinburgh.
- SIEGEL, A. F.—MORGAN, C. J.
1996² *Statistics and Data Analysis. An Introduction*. New York.
- STEWART, A. F.
1977 *Skopas of Paros*. Park Ridge, N.J.
- TOMLINSON, R. A.
1983 *Epidaurus*. Austin.
- TREU, G.
1881 'Fragmente aus den tegeatischen Giebelgruppen des Skopas,' *AM* 6, 393–423.
- VALLOIS, R.
1978 *L'architecture hellénique et hellénistique à Délos jusqu'à l'éviction des déliens (166 Av. J.-C.) II.2*. BEFAR 157. Paris.
- VOYATZIS, M. E.
1990 *The Early Sanctuary of Athena Alea at Tegea. And Other Archaic Sanctuaries in Arcadia*. Studies in Mediterranean Archaeology and Literature 97. Göteborg.
- WALDSTEIN, C.
1902 *The Argive Heraeum I*. Boston and New York.
- WÄLKENS, M.—DE PAEPE, P.—MOENS, L.
1988 'Patterns of Extraction and Production in the White Marble Quarries of the Mediterranean: History, Present Problems and Prospects,' in J. C. Fant (ed.), *Ancient Marble Quarrying and Trade*, BAR International Series 453. Oxford.

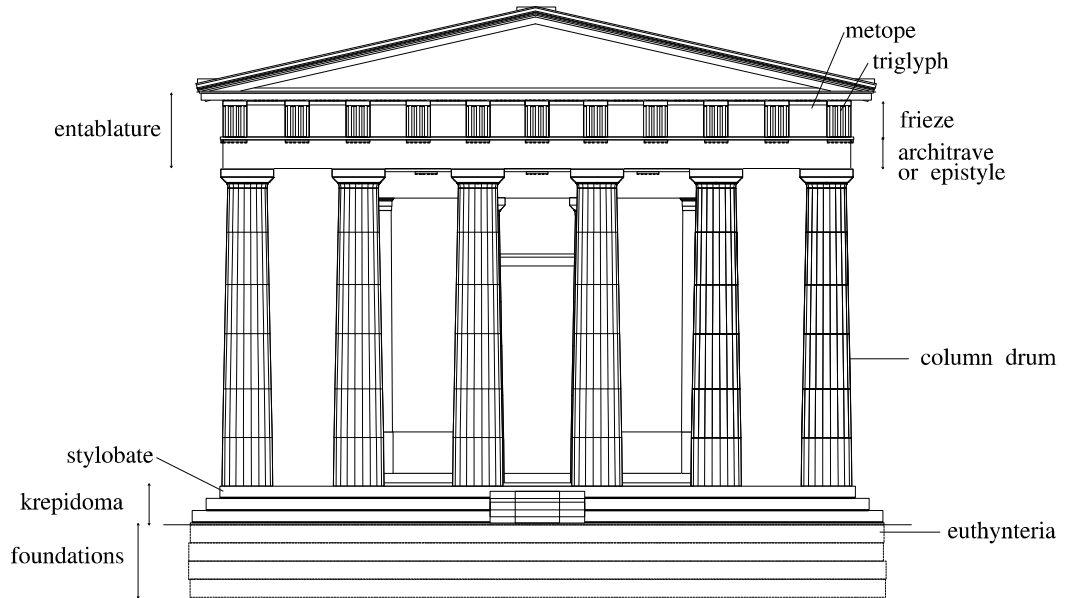

Fig. 29. Technical terms for building façade.

Glossary of Architectural Terms

abacus	The flat slab forming the top part of the capital.
anathyrosis other;	Smooth contact band at the edges of a block joined with another; the central part of the surface is roughly cut.
annulets	The projecting rings between the neck (trachelion) and the echinus of the capital; see Fig. 12 on p. 33.
architrave 29.	Lintel block carried by columns, also called epistyle; see Fig. 29.
arris	Sharp edge between two column flutes of a Doric column.
cella	Central room of a temple.
column drum	One course of a column shaft; see Fig. 29.
dowel	Attachment used to secure blocks to the course below them; in Tegea the dowels are of iron with molten lead around them.
echinus	Convex part of a Doric capital connecting the annulets and the abacus.
empolion	Block at the centre of the column drum joint. Usually wooden, it consists of three parts: two which fit into the square cuttings of the adjoining drums, each with a round hole for the wooden centring pin.
entasis	The slightly convex curve of the column taper.
entablature	Superstructure of a building carried by columns; includes the architrave, frieze and cornice; see Fig. 29.
euthynteria	Top course of foundations; see Fig. 29.
flute	Vertical channel of a column shaft.
foundations	Courses of blocks often needed to support e.g. krepidoma or cella wall; see Fig. 29.
frieze	Central part of an entablature; see Fig. 29.
gutta	Small cylindrical cuttings used in the Doric order under a regula and mutule.
krepidoma	Platform of a temple, usually consisting of three steps; see Fig. 29.
metope	Panels of a Doric frieze; see Fig. 29.
mutule	Projecting slab at the bottom of a Doric cornice block.
opisthodomos	Rear porch of a temple; cf. pronaos.
pronaos	Front porch of a temple enclosed by side walls and by columns in front.
regula	Rectangular strip under the taenia of a Doric architrave.
stylobate	Top step of a krepidoma; see Fig. 29.
taenia	Fascia at the top of a Doric architrave.
tholos	Circular building.
triglyph	Projecting member of a Doric frieze, between metopes and with two vertical grooves; see Fig. 29.
trachelion	The neck of the capital; see Fig. 12 on p. 33.

Appendix A: Column drums

General abbreviations used in the appendix are listed on p. iii.
All measurements in meters unless otherwise stated.

Bl#	Block number
Dug#	Drum number in Dugas <i>et al.</i> 1924, app. II, 131–133
Pos	Position of the drum within the shaft

Table A1. Column drum diameter measurements (A2–3)

L	Lower diameter; measurement taken between flutes
U	Upper diameter; measurement taken between flutes
1A	Measurement taken between flutes 1A–10B
2A	Measurement taken between flutes 2A–9B
3A	Measurement taken between flutes 3A–8B
4A	Measurement taken between flutes 4A–7B
5A	Measurement taken between flutes 5A–6B
6A	Measurement taken between flutes 6A–5B
7A	Measurement taken between flutes 7A–4B
8A	Measurement taken between flutes 8A–3B
9A	Measurement taken between flutes 9A–2B
10A	Measurement taken between flutes 10A–1B

Table A2. Column drum height measurements (A4–5)

1A–10A,	Height of the drum measured along the bottom of the flute
10B–1B	

Table A3. Column drums: measurement averages, margins, and differences (A6–8)

Av	Average of new measurements
Dugas	Measurement given in Dugas <i>et al.</i> 1924, app. II, 131–133
–	Negative margin of the new measurement
+	Positive margin of the new measurement
N	Number of new measurements taken of the drum
Differences = Dugas – Av	Printed in <i>italics</i> are the cases where the difference between Clemmensen's and the new column drum measurement (App. II, Dugas <i>et al.</i> 1924, 131–133) is larger than the error margin established on the basis of new measurements (see p. A8).

Catalogue of Column Drums and Drum Fragments (A9–42)

All photographs by J.P.

Schematic Drawings of Empolion and Dowel Holes (A43–59)

Scale 1:30 (original scale 1:25).

For drums in an upright position a north arrow is drawn next to the arris or flute facing north, and for drums lying on one side the top arris or flute is given an arrow pointing upwards.

Matching Drums (A60–61)

A4 The Temple of Athena Alea at Tegea

Table A2. Column drum height measurements.

Bl#	Dug#	Pos	1A	2A	3A	4A	5A	6A	7A	8A	9A	10A	10B	9B	8B	7B	6B	5B	4B	3B	2B	1B		
3	D13	B	1.464	1.464	1.466	1.466	1.465	1.464	-	1.464	-	1.463	1.463	1.463	1.463	-	-	-	-	-	-	-	-	
5	D15	D	1.659	-	-	-	-	-	-	-	-	-	-	-	1.655	1.657	1.658	1.658	1.660	1.657	1.658	1.659	1.659	
6	D16	B	-	1.470	-	-	1.473	-	1.473	-	1.473	-	-	-	-	-	-	-	-	-	-	1.471	1.471	
7	D17	D	-	-	1.514	-	-	1.516	-	1.516	-	1.514	-	1.514	-	1.513	-	1.512	-	1.513	-	-	1.515	1.515
8	D18	A	1.474	1.466	1.466	1.463	1.460	1.455	1.458	1.462	1.457	1.456	1.462	1.458	-	-	-	-	1.666	1.470	1.473	1.473	1.473	
9	D19	C	-	-	-	-	-	-	-	-	-	-	-	-	-	-	-	-	-	1.666	1.669	-	-	
15	D23	C	1.399	-	-	-	-	-	-	-	-	-	-	-	-	-	-	-	-	-	-	-	-	
20	D27	E	-	-	-	-	-	1.387	1.385	-	-	-	-	-	-	-	-	1.373	-	-	-	-	-	
21	D28	A	1.472	1.473	1.472	-	1.472	1.468	1.467	1.463	1.464	-	-	-	-	-	-	-	-	-	-	-	1.470	
22	D29	F	1.318	-	-	-	-	1.323	-	-	-	-	-	-	1.319	1.319	1.321	1.319	1.318	1.319	1.320	1.319	1.319	
24	D30	B	1.482	1.479	-	-	1.482	-	1.485	1.482	1.477	-	-	-	-	-	-	-	-	-	-	-	-	
27	D01	C	-	-	-	-	-	1.441	1.444	-	1.444	1.445	-	-	-	-	-	-	-	-	-	-	-	
33	D05	D	-	-	-	-	-	-	-	-	-	-	-	1.480	1.478	1.480	1.481	1.480	1.481	1.480	1.480	-	-	
35	D06	D	-	1.494	-	-	-	-	-	-	-	-	-	1.493	1.493	1.492	-	-	1.493	-	-	-	-	
36	D07	B	-	-	-	-	-	-	-	-	-	-	-	1.476	1.476	-	-	-	-	-	-	-	-	
45	D08	B	-	-	-	-	-	-	-	-	-	-	-	1.478	1.478	-	-	-	-	-	-	-	-	
46	D09	C	-	-	-	-	-	-	1.477	-	-	-	-	-	-	-	-	-	-	-	-	1.479	1.480	
47	D10	A	1.475	-	1.473	1.471	1.472	1.472	1.471	1.469	1.470	1.470	1.469	-	-	-	-	-	-	-	-	-	1.475	
48	D11	A	1.475	1.478	1.477	1.477	1.475	1.476	1.476	1.473	1.475	1.472	1.473	1.469	-	-	-	1.469	1.468	1.468	1.469	1.471	1.471	
51	D72	A	1.473	-	-	-	-	-	-	-	-	-	1.472	1.474	1.474	1.474	1.475	1.476	1.475	1.474	1.474	1.474	1.474	
77	D75	F	-	-	-	-	-	-	-	-	1.631	-	-	-	-	-	-	-	-	-	-	-	-	
79	D77	B	-	1.482	-	-	-	-	-	-	-	-	-	-	-	-	-	-	-	-	-	-	-	
80	D78	D	-	-	-	-	-	-	-	-	-	-	-	1.708	-	1.707	1.707	1.708	1.708	-	1.708	-	-	
88	D80	E	1.661	1.661	-	1.660	1.660	-	-	-	1.663	-	1.663	1.663	-	-	-	-	-	-	-	-	-	
89	D82	F	-	-	-	-	-	-	-	-	-	-	1.332	-	1.331	1.330	-	-	-	-	-	-	-	
90	D83	D	-	-	-	-	-	-	1.415	-	-	-	-	-	-	-	-	-	-	-	-	-	-	
91	D84	B	-	-	-	-	-	-	-	-	-	-	-	-	-	1.470	-	1.468	-	-	-	-	-	

Table A3. Column drums: measurement averages, margins, and differences.

Bl#	Dug#	Pos	Lower diameters						Upper diameters						Height			Differences		
			Av	Dugas	-	+	N	Av	Dugas	-	+	N	Av	Dugas	-	+	N	DiamL	DiamU	Height
3	D13	B	1.419	1.420	-0.001	0.002	3	1.373	1.375	-0.004	0.003	2	1.464	1.467	-0.001	0.002	11	0.001	0.002	0.003
5	D15	D	1.331	1.332	-0.003	0.002	2	1.270	1.272	-0.003	0.002	4	1.658	1.658	-0.003	0.002	9	0.001	0.002	0.000
6	D16	B	1.421	1.425	-0.002	0.002	2	1.380	1.378	-0.003	0.003	1	1.472	1.472	-0.003	0.002	5	0.004	-0.002	0.000
7	D17	D	1.323	1.322	-0.002	0.003	3	1.267	1.268	-0.004	0.004	1	1.514	1.515	-0.002	0.002	9	-0.001	0.008	0.001
8	D18	A	1.458	1.454	-0.004	0.004	1	1.412	1.421	-0.002	0.002	4	1.465	1.465	-0.009	0.009	15	-0.004	0.009	0.000
9	D19	C	1.375	1.377	-0.003	0.003	1	1.322	1.324	-0.002	0.003	3	1.668	1.675	-0.004	0.003	2	0.002	0.002	0.007
15	D23	C	1.375	1.376	-0.003	0.003	1	1.337	1.333	-0.004	0.003	2	1.399	1.392	-0.005	0.005	1	0.001	-0.004	-0.007
20	D27	E	1.264	1.264	-0.004	0.004	1	1.212	1.211	-0.003	0.003	2	1.382	1.380	-0.010	0.010	3	0.000	-0.001	-0.002
21	D28	A	1.453	1.454	-0.004	0.004	1	1.421	1.420	-0.004	0.004	1	1.469	1.469	-0.007	0.005	9	0.001	-0.001	0.000
22	D29	F	1.214	1.211	-0.003	0.003	1	1.151	1.155	-0.004	0.003	2	1.320	1.323	-0.003	0.003	10	-0.003	0.004	0.003
24	D30	B	1.414	1.421	-0.002	0.002	2	1.376	1.375	-0.004	0.004	1	1.481	1.482	-0.004	0.004	6	0.007	-0.001	0.001
27	D01	C	1.377	1.375	-0.002	0.001	3	-	1.332	-0.004	0.004	-	1.444	1.445	-0.003	0.002	4	-0.002	-	0.001
33	D05	D	1.328	1.329	-0.002	0.001	2	1.280	1.278	-0.004	0.004	1	1.480	1.480	-0.002	0.001	8	0.001	-0.002	0.000
35	D06	D	1.326	1.325	-0.004	0.003	1	1.269	1.271	-0.003	0.002	4	1.493	1.494	-0.002	0.002	5	-0.001	0.002	0.001
36	D07	B	1.423	1.423	-0.004	0.004	1	1.375	1.377	-0.004	0.004	1	1.476	1.477	-0.005	0.005	1	0.000	0.002	0.001
45	D08	B	1.418	1.420	-0.002	0.002	5	1.370	1.375	-0.005	0.005	1	1.478	1.478	-0.004	0.004	2	0.002	0.005	0.000
46	D09	C	1.371	1.372	-0.003	0.003	1	1.322	1.325	-0.003	0.003	1	1.479	1.478	-0.004	0.003	3	0.001	0.003	-0.001
47	D10	A	1.459	1.459	-0.004	0.003	2	1.420	1.420	-0.002	0.001	7	1.472	1.472	-0.003	0.003	12	0.000	0.000	0.000
48	D11	A	-	-	-	-	-	1.417	1.419	-0.005	0.004	7	1.473	1.474	-0.005	0.005	17	-	0.002	0.001
51	D72	A	1.458	1.457	-0.003	0.003	1	1.422	1.420	-0.002	0.001	10	1.474	1.472	-0.002	0.002	11	-0.001	-0.002	-0.002
77	D75	F	-	-	-	-	-	-	-	-	-	-	1.631	1.632	-0.005	0.005	1	-	-	0.001
79	D77	B	-	1.426	-0.003	0.003	-	-	1.379	-0.003	0.003	-	1.482	1.483	-0.003	0.003	1	-	-	0.001
80	D78	D	1.331	1.330	-0.002	0.002	3	1.271	1.269	-0.003	0.002	2	1.708	1.709	-0.002	0.001	6	-0.001	-0.002	0.001
88	D80	E	1.279	1.279	-0.002	0.002	2	1.216	1.215	-0.003	0.002	2	1.662	1.662	-0.002	0.001	7	0.000	-0.001	0.000
89	D82	F	-	1.215	-0.003	0.003	-	-	1.158	-0.003	0.003	-	1.331	1.332	-0.005	0.005	3	-	-	0.001
90	D83	D	-	1.326	-0.004	0.004	-	-	1.275	-0.004	0.004	-	1.415	1.413	-0.005	0.005	1	-	-	-0.002
91	D84	B	1.423	1.422	-0.003	0.003	1	1.377	1.380	-0.003	0.003	1	1.469	1.472	-0.003	0.003	2	-0.001	0.003	0.003

Bl#	Dug#	Pos	Lower diameters						Upper diameters						Height			Differences		
			Av	Dugas	-	+	N	Av	Dugas	-	+	N	Av	Dugas	-	+	N	DiamL	DiamU	Height
92	D85	C	1.378	1.381	-0.003	0.003	1	1.325	1.328	-0.003	0.003	2	1.643	1.643	-0.001	0.001	7	0.003	0.003	0.000
93	D86	A	-	-	-	-	1	1.426	1.420	-0.004	0.004	1	1.466	1.467	-0.005	0.005	4	-	-0.006	0.001
94	D87	C	-	1.374	-0.003	0.003	1	1.328	1.331	-0.003	0.003	1	1.413	1.413	-0.003	0.002	2	-	0.003	0.000
115	D33	E	1.272	1.272	-0.003	0.002	2	1.210	1.211	-0.002	0.002	2	1.580	1.579	-0.002	0.001	2	0.000	0.001	-0.001
135	D34	C	1.378	1.377	-0.002	0.002	2	1.323	1.328	-0.003	0.003	1	1.498	1.498	-0.002	0.002	2	-0.001	0.005	0.000
182	D31?	F	1.209	1.213	-0.003	0.003	1	1.156	1.156	-0.002	0.001	2	1.479	1.381	-0.001	0.001	6	0.004	0.000	-0.008
363	D37	C	1.375	1.377	-0.003	0.003	1	1.338	1.337	-0.003	0.002	2	1.321	1.321	-0.003	0.002	2	0.002	-0.001	0.000
395	D40	B	1.421	1.423	-0.003	0.003	1	1.377	1.377	-0.003	0.003	1	1.474	1.473	-0.003	0.003	2	0.002	0.000	-0.001
397	D41	C	-	-	-	-	1	1.216	1.216	-0.002	0.002	-	1.561	1.566	-0.005	0.005	1	-	-	0.005
401	D38	E	1.274	1.271	-0.003	0.003	1	1.216	1.216	-0.002	0.002	2	1.411	1.404	-0.003	0.003	1	-0.003	0.000	-0.007
415	D44	D	-	1.326	-0.003	0.003	-	1.274	1.274	-0.003	0.003	1	1.447	1.451	-0.003	0.003	2	-	-	0.004
454	D47	E	1.268	1.265	-0.003	0.002	2	1.212	1.213	-0.001	0.001	2	1.368	1.369	-0.001	0.001	3	-0.003	0.001	0.001
455	D46	D	-	-	-	-	1	1.267	1.269	-0.003	0.003	1	-	-	-	-	-	-	0.002	-
492	D51	D	-	1.321	-0.003	0.003	-	1.268	1.270	-0.002	0.002	2	1.448	1.448	-0.002	0.002	2	-	0.002	0.000
497	-	E	1.268	-	-0.003	0.003	1	1.218	-	-0.003	0.003	1	1.347	-	-0.003	0.003	1	-	-	-
498	-	B	1.420	-	-0.003	0.003	1	1.370	-	-0.003	0.003	1	1.484	-	-0.003	0.002	2	-	-	-
506	-	C	1.379	-	-0.002	0.001	1	1.329	-	-0.002	0.001	2	1.510	-	-0.002	0.002	5	-	-	-
507	D53	F	1.206	-	-0.004	0.004	1	1.155	1.157	-0.003	0.003	1	1.349	1.347	-0.006	0.004	5	-	0.002	-0.002
529	-	B	1.418	-	-0.002	0.002	1	1.376	-	-0.002	0.002	1	1.473	-	-0.003	0.002	2	-	-	-
533	-	E	1.274	-	-0.002	0.002	1	1.223	-	-0.002	0.002	2	1.356	-	-0.002	0.002	2	-	-	-
542	D65	F	1.220	1.219	-0.002	0.002	1	1.154	1.159	-0.003	0.003	1	1.500	1.503	-0.003	0.005	3	-0.001	0.005	0.003
544	D66	F	1.215	1.217	-0.002	0.002	1	1.158	1.158	-0.003	0.003	1	1.484	1.482	-0.005	0.004	4	0.002	0.000	-0.002
561	-	B	1.417	-	-0.003	0.003	1	1.374	-	-0.003	0.003	1	1.477	-	-0.002	0.002	3	-	-	-
563	D70	B	1.418	1.419	-0.002	0.002	1	1.377	1.375	-0.003	0.003	1	1.478	1.478	-0.002	0.002	2	0.001	-0.002	0.000
564	D71	A	1.455	1.457	-0.003	0.003	1	1.416	1.419	-0.003	0.003	1	1.472	1.473	-0.003	0.002	5	0.002	0.003	0.001
809	-	C	1.365	-	-0.005	0.005	1	1.332	-	-0.002	0.002	1	1.457	-	-0.003	0.002	2	-	-	-

Differences

Cases where the difference between the new and Clemmensen's column drum measurement (app. II, Dugas *et al.* 1924, 131–133) is larger than the error margin established on the basis of new measurements:

Bl#	Dug#		
3	D13	H:	Based on 11 measurements. Likely more accurate than app. II.
6	D16	Diam _U :	Edge of the block largely broken. Caliper measurement likely more accurate than app. II.
8	D18	Diam _U :	Based on 4 measurements and rechecked. Edge broken. Caliper measurement likely more accurate than app. II.
9	D19	H:	Lower surface largely broken. Caliper measurement likely more accurate than app. II. Clemmensen gives also a shorter measurement of 1.670 m in parentheses (p. 132) which reduces the difference only to 2 mm.
15	D23	H:	Lower surface largely broken. Caliper measurement likely more accurate than app. II.
22	D29	Diam _U :	Presently against ground. Measurement rechecked.
24	D30	Diam _U :	Edge of the block broken. Caliper measurement likely more accurate than app. II.
93	D86	Diam _U :	Measurement rechecked. Caliper measurement likely more accurate than app. II.
135	D34	Diam _U :	Edge of the block broken. Caliper measurement likely more accurate than app. II.
182	D31?	Diam _U :	Block reused: mortar on the side makes the measurement larger for diameter 10A–1B. Flutes 9A–2B without mortar, measurement accurate.
		H:	Printing error of 10 cm in publication?
401	D38	H:	Edge of the top surface broken. Caliper measurement likely more accurate than app. II.
415	D44	H:	Edges preserved, measurement rechecked. Caliper measurement likely more accurate than app. II.
542	D65	Diam _U :	Edge of the top surface broken. Caliper measurement likely more accurate than app. II.

Catalogue of Column Drums and Drum Fragments

Measurements taken between preserved surfaces underlined.

Measurements adopted from Dugas *et al.* (1924, App. II, 131–133) with *italics*.

If the drum is listed in Dugas *et al.* (1924, App. II, 131–133), the Dugas drum number is given in parentheses before the measurements.

The measurement margin is given in parentheses.

For general abbreviations see p. ii.

C Co-ordinates of the block.



Blocks 2 (left) and 3 (right).

2. Column drum fragment. Partially preserved upper surface, probably also lower. With 1 dowel hole. 8 flutes. Pres. c. 1/3. Pos. A. H: 1.48. FIW_U: 0.235. C: Dowel hole, E-most. X: 3.11 Y: 10.07 Z: 0.26

3. Column drum. Bottom and top surfaces almost complete. With empolion and 2 dowel holes. Presently upside down. Pres. c. 1/1. (=D13) Pos: B. Diam_L: 1.419 (1.418–1.421). Diam_U: 1.373 (1.369–1.376). H: 1.464 (1.463–1.466). FIW_L: 0.234–0.235. FIW_U: 0.228. Diam_{LA}: c. 1.49. C: Empolion. X: 4.43 Y: 9.49 Z: 0.21

4. Column drum. Lower surface probably preserved, upper broken, 7 flutes. Pres. c. 1/2. Pos. B. H: c. 1.10–15. FIW_L: 0.235–0.236. C: On broken surface, 0.13 m from the S-most arris. X: 12.75 Y: 14.54 Z: 0.63



Blocks 5 (left) and 6 (right).

5. Column drum. Top surface partially broken, with empolion and 1 dowel hole. Bottom surface preserved, 19 flutes. Pres. c. 9/10. (=D15) Pos: D. Diam_L: 1.331 (1.328–1.333). Diam_U: 1.270 (1.267–1.272). H: 1.658 (1.655–1.660). FIW_L: 0.219–0.220. FIW_U: 0.208–0.210. Diam_{LA}: c. 1.39. Diam_{UA}: c. 1.31. C: Dowel hole. X: 18.78 Y: 9.91 Z: 1.34

6. Column drum. Bottom surface, with empolion and 2 dowel holes, slightly broken; top surface partially broken. Presently upside down. 14 flutes. Pres. c. 3/4. (=D16) Pos: B. Diam_L: 1.421 (1.419–1.423). Diam_U: 1.380 (1.377–1.383). H: 1.472 (1.469–1.474). FIW_L: 0.235. FIW_U: 0.228. Diam_{LA}: 1.492. Diam_{UA}: c. 1.445. C: Empolion. X: 20.35 Y: 9.28 Z: 1.16



Blocks 7 (right) and 8 (left).

7. Column drum. Edges of the top surface broken. Empolion and 2 dowel holes. Bottom surface well preserved. 20 flutes. Rectangular cutting for an arris repair on the SE side. Matches with 9 (C-drum). Pres. c. 1/1. (=D17) Pos: D. Diam_L: 1.323 (1.321–1.326). Diam_U: 1.267 (1.263–1.270). H: 1.514 (1.512–1.516). FIW_L: 0.216–0.218. FIW_U: –. Diam_{UA}: c. 1.31. C: SE Dowel hole. X: 21.35 Y: 11.37 Z: 1.23

8. Column drum. Top surface with empolion and 2 dowel holes, edges badly broken; bottom surface slightly broken. 16 flutes. Pres. c. 9/10. (=D18) Pos: A. Diam_L: 1.458 (1.454–1.462). Diam_U: 1.412 (1.410–1.414). H: 1.465 (1.456–1.474). FIW_L: 0.239. FIW_U: –. Diam_{LA}: c. 1.535. Diam_{UA}: 1.465. C: Empolion. X: 22.30 Y: 10.58 Z: 1.09



Block 9.

9. Column drum. Bottom surface partially preserved, with empolion and 1 dowel hole, top surface well preserved with a dowel still in place. 20 flutes. Presently upside down. Matches with 7 (D-drum). Pres. c. 9/10. (=D19) Pos: C. Diam_L: 1.375 (1.372–1.378). Diam_U: 1.322 (1.320–1.325). H: 1.668 (1.664–1.671). FIW_L: –. FIW_U: 0.218–0.220. Diam_{UA}: 1.395. C: Empolion. X: 24.96 Y: 9.89 Z: 1.31

10. Column drum fragment. Top surface partially preserved. 14 flutes. Presently upside down. Fluting too shallow to be from pronaos order. Pres. c. 1/3. Pos: F. Diam_L: c. 1.18. H: 0.88. FIW_T: 0.189–0.191. Diam_{LA}: c. 1.24.

C: On broken surface, 0.07 m from the S-most arris. X: 25.86 Y: 11.22 Z: -0.07

12. Column drum fragment. Bottom surface partially preserved, with empolion and 1 dowel hole, nothing of the top surface. Presently upside down. 11 flutes. Pres. c. 2/5. Pos: F. H: c. 1.32. FIW_L: c. 0.194. C: Empolion. X: 27.52 Y: 11.59 Z: 0.74

13. Column drum fragment. Bottom surface partially preserved with remains of empolion hole, lower surface apparently also. Presently upside down. 8 flutes. Pres. c. 2/5. Pos: E. H: 1.515. FIW_L: 0.210–0.211. FIW_U: 0.202. C: Empolion. X: 27.24 Y: 9.52 Z: 0.99



Blocks 13 (left) and 15 (right).

14. Column drum fragment. Probably something left of the top surface, bottom gone. Presently upside down. 5 + 4 flutes. Pres. c. 2/5.
Pos: E. H: c. 1.10. FIW_U: 0.200.
C: On broken surface, 0.13 m from the S-most aris. X: 28.77 Y: 10.75 Z: 0.70

15. Column drum. Bottom surface partially preserved (with empolion and 1 dowel hole), top surface slightly better. 15 flutes. Presently upside down. Cracking on S-side showing the crystal structure of the marble. Pres. c. 3/4.
(=D23) Pos: C. Diam_L: 1.375 (1.372–1.378).
Diam_U: 1.337 (1.333–1.340). H: 1.399 (1.394–1.404). FIW_L: –. FIW_U: 0.221. Diam_{LA}: 1.423.
C: Empolion. X: 28.66 Y: 9.43 Z: 1.06

16. Column drum. Split in two, the other half is block 17. Small piece left of the top surface (1 dowel hole), bottom surface almost complete. 11 flutes. Pres. c. 1/2.
Pos: E. H: 1.398. FIW_U: 0.198–0.199. FIW_L: –.
C: Dowel hole. X: 30.30 Y: 9.39 Z: 1.00

17. Column drum. Split in two, the other half is block 16. Of the top surface a segment of one third broken off, bottom almost completely broken (remains of a dowel hole). 13 flutes. Presently upside down. Pres. c. 1/2.

Pos: E. Diam_U: c. 1.19. H: 1.398. FIW_U: 0.199–0.201. FIW_L: –.
C: Dowel hole. X: 31.76 Y: 11.64 Z: 0.98

18. Column drum fragment. Traces left of top surface (empolion, no dowel holes), nothing of lower. 18 flutes. Pres. c. 2/5.
Pos: F. Diam_U: c. 1.17. H: c. 1.07. FIW: 0.190.
C: Empolion. X: 32.88 Y: 11.45 Z: 0.35

20. Column drum. Something left of the bottom surface (remains of empolion hole, no dowel holes), more of the top. 20 flutes. Presently upside down. Pres. c. 4/5.
(=D27) Pos: E. Diam_L: 1.264 (1.260–1.268).
Diam_U: 1.212 (1.209–1.215). H: 1.382 (1.372–1.392). FIW_L: c. 0.207. FIW_U: c. 0.200.
Diam_{LA}: c. 1.25.
C: Empolion. X: 36.39 Y: 11.78 Z: 0.62

21. Column drum. Bottom and top surfaces about half broken; bottom with remains of empolion and perhaps of 1 dowel hole. 12 flutes. Presently upside down. Pres. c. 3/5.
(=D28) Pos: A. Diam_L: 1.453 (1.449–1.457).
Diam_U: 1.421 (1.417–1.425). H: 1.469 (1.462–1.474). FIW_L: c. 0.242. FIW_U: 0.236. Diam_{LA}: 1.48. C: Empolion. X: 35.61 Y: 9.62 Z: 1.04



Block 20.

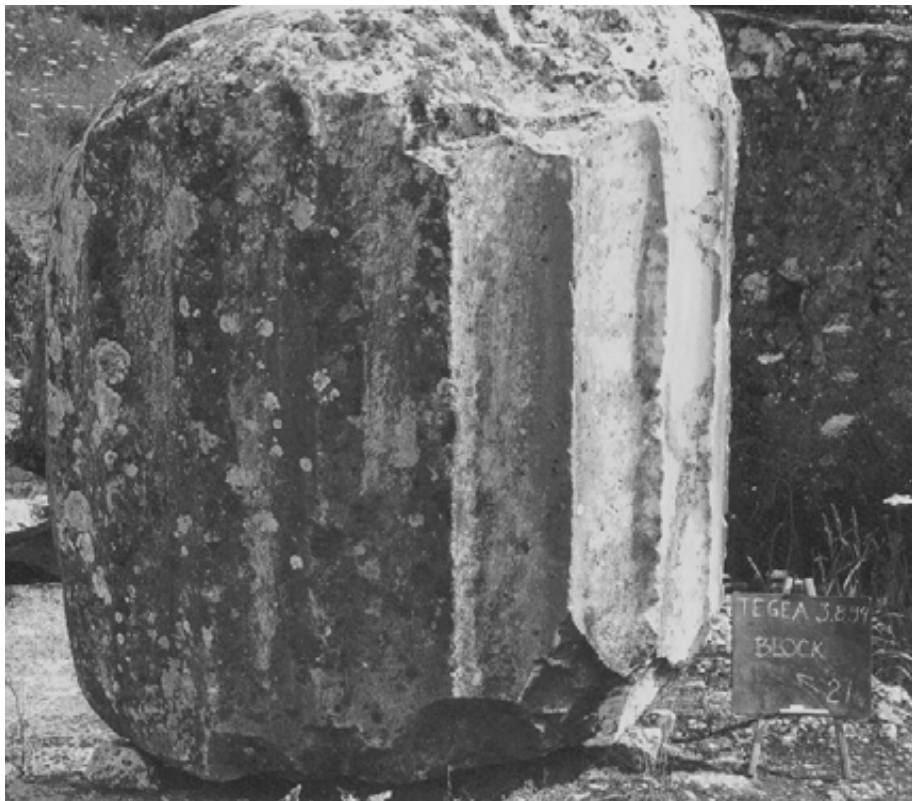

Block 21.

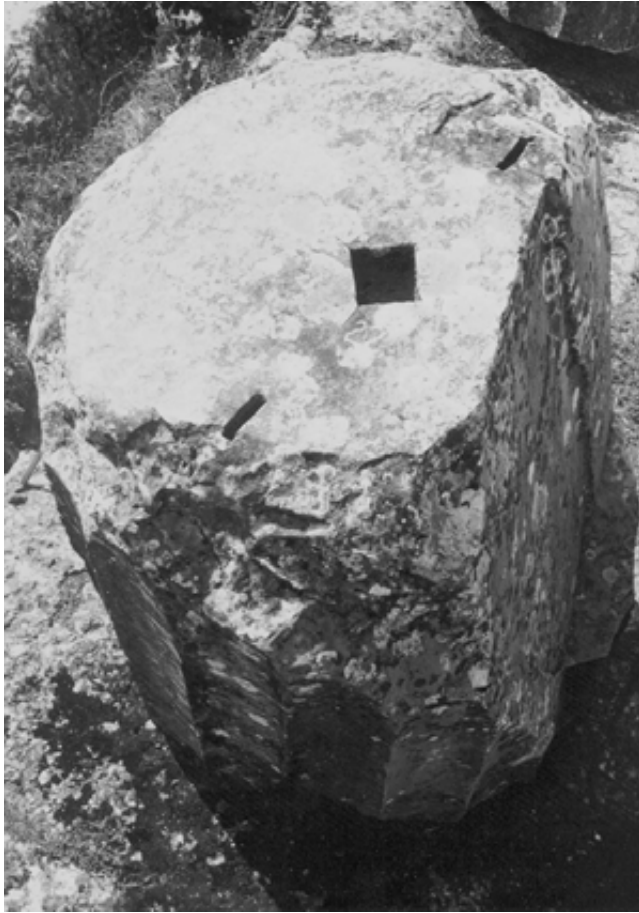

Block 22.



Block 24.

22. Column drum. Top surface complete, bottom (2/3 pres.) with empolion and 2 dowel holes. Presently upside down. Pres. c. 4/5. (=D29) Pos: F. Diam_L: 1.214 (1.211–1.217). Diam_U: 1.151 (1.147–1.154). H: 1.320 (1.317–1.323). FIW_L: c. 0.196. FIW_U: 0.189–0.190. Diam_{LA}: 1.26. C: Empolion. X: 35.88 Y: 7.08 Z: 0.94

24. Column drum. Both surfaces partially preserved, bottom with empolion and 1 dowel hole. 17 flutes. Presently upside down. Pres. c. 9/10. (=D30) Pos: B. Diam_L: 1.414 (1.412–1.416).

Diam_U: 1.376 (1.372–1.380). H: 1.481 (1.477–1.485). FIW_L: -. FIW_U: 0.228–0.229. Diam_{LA}: 1.47.

C: Empolion. X: 35.82 Y: 3.45 Z: 1.08

25. Column drum fragment. Upper surface fairly well preserved (empolion and 1 dowel hole, traces of another), lower broken. 13 flutes. Pres. c. 2/5.

Pos: A. Diam_U: c. 1.42. H: 0.99. FIW_U: c. 0.235. Diam_{UA}: c. 1.48.

C: On the bottom of the top flute, 0.11 m S of the N edge. X: 38.76 Y: 0.89 Z: 0.71



Block 27.

27. Column drum. Partially preserved bottom surface (with empolion and 2 dowel holes), top more broken. 14 flutes. Presently upside down. Pres. c. 3/4.

(=D01) Pos: C. Diam_L: 1.377 (1.375–1.378). Diam_U: 1.332 (1.328–1.336). H: 1.444 (1.441–1.446). FIW_L: 0.227. FIW_U: c. 0.220. Diam_{LA}: 1.43. C: Empolion. X: 40.82 Y: 0.99 Z: 0.86

29. Column drum. Bottom surface well preserved, upper broken. 20 flutes. Pres. c. 1/2. Pos: E. Diam_L: 1.28. H: 0.99. FIW_L: 0.208–

0.210. Diam_{LA}: c. 1.33. C: Approx. Centre of broken surface. X: 35.93 Y: 0.41 Z: 0.48

30. Column drum fragment. Something preserved of lower surface, nothing of upper. 7 flutes. Pres. c. 2/5.

Pos: E/F. H: c. 1.26. FIW: c. 0.195.

C: On broken surface above an arris on the N side 0.03 m of the edge. X: 34.79 Y: 0.88 Z: 0.46



Block 33.



Blocks 35 (right) and 36 (left).

33. Column drum. Both surfaces with an empolion and 2 dowel holes. 20 flutes. Presently upside down. Fragment at the foot (block 34) broken off the bottom surface. Pres. c. 9/10. (=D05) Pos: D. Diam_L: 1.328 (1.326–1.329). Diam_U: 1.280 (1.276–1.284). H: 1.480 (1.478–1.481). FIW_L: 0.217–0.219. FIW_U: c. 0.211. Diam_{UA}: 1.339.
C: Empolion. X: 35.03 Y: -1.50 Z: 1.10

34. Column drum fragment. Broken off from block 33. In photograph at the foot of the drum. Pres. c. 9/10.
C: SW edge, highest point. X: 35.01 Y: -2.21 Z: 0.33

35. Column drum. Both surfaces with an empolion and 2 dowel holes. 20 flutes. Matches with 115 (drum E). In the photograph on the right. Pres. c. 1/1. (=D06) Pos: D. Diam_L: 1.326 (1.322–1.329). Diam_U: 1.269 (1.266–1.271). H: 1.493 (1.491–1.495). FIW_L: 0.219. FIW_U: 0.209–0.211. Diam_{UA}: 1.334.
C: Empolion. X: 35.91 Y: -7.49 Z: 1.10

36. Column drum. Bottom surface only fragmentarily preserved (1 dowel hole), top almost completely. 20 flutes. Presently upside down. In the photograph on the left. Pres. c. 2/3. (=D07) Pos: B. Diam_L: 1.423 (1.419–1.427). Diam_U: 1.375 (1.371–1.379). H: 1.476 (1.471–1.481). FIW_L: -. FIW_U: 0.226–0.227. Diam_{UA}: 1.462.
C: Centre point of the edge on the upper surface. X: 33.39 Y: -7.98 Z: 1.18

39. Column drum fragment. Something preserved of the lower surface, nothing of the upper. 5 flutes. Part of the same drum as block 40. Pres. c. 1/6.
Pos: F. H: c. 1.00. FIW: c. 0.195.
C: E end, 0.07 m to W. X: 29.18 Y: -8.59 Z: 0.31

40. Column drum fragment. Something preserved of the lower surface, nothing of the upper. 6 flutes. Part of the same drum as block 39. Pres. c. 1/5.
Pos: F. H: c. 1.10. FIW: c. 0.195.
C: NW corner, 0.09 m from W edge. X: 27.08 Y: -8.26 Z: 0.36



Blocks 45 (right) and 46 (left).

45. Column drum. One fourth of the bottom surface broken (1 dowel and empolion hole), top almost complete. 20 flutes. Presently upside down. Pres. c. 9/10. Photograph on previous page.

(=D08) Pos: B. Diam_L: 1.418 (1.416–1.420). Diam_U: 1.370 (1.365–1.375). H: 1.478 (1.474–1.482). FIW_L: 0.235–0.236. FIW_U: 0.227–0.228. Diam_{LA}: 1.494.

C: Empolion. X: 17.61 Y: -8.05 Z: 1.12

46. Column drum. Of the top surface less than half preserved, of the bottom slightly more. Empolion hole fragmentarily preserved, no dowel holes. 11 flutes. Pres. c. 3/5. Photograph on previous page.

(=D09) Pos: C. Diam_L: 1.371 (1.368–1.374). Diam_U: 1.322 (1.319–1.325). H: 1.479 (1.475–1.482). FIW_L: 0.226–0.228. FIW_U: 0.219. Diam_{UA}: 1.375.

C: Empolion. X: 16.43 Y: -8.11 Z: 1.14



Block 47.

47. Column drum. Edges of the top surface broken, with empolion and 1 complete and 1 partially preserved dowel hole. Bottom almost complete. 20 flutes. Pres. c. 7/8.

(=D10) Pos: A. Diam_L: 1.459 (1.455–1.462). Diam_U: 1.420 (1.418–1.421). H: 1.472 (1.469–1.475). FIW_L: 0.241. FIW_U: -. Diam_{UA}: 1.49. C: Empolion. X: 13.01 Y: -8.29 Z: 1.12

48. Column drum. Edges of the top surface broken, bottom less preserved. Stands on the euthynteria. 2 dowel holes and empolion hole. 20 flutes. Pres. c. 4/5.

(=D11) Pos: A. Diam_L: -. Diam_U: 1.417 (1.412–1.421). H: 1.473 (1.468–1.478). FIW_L: -. FIW_U: -. Diam_{UA}: 1.49. C: Empolion. X: 9.60 Y: -6.80 Z: 1.37

50. Column drum fragment. Something preserved of the lower surface, nothing of upper. 5 flutes. Pres. c. 1/8.

Pos. F. H: 0.70 FIW: c. 0.196.

C: On bottom of 2nd flute from S, 0.15 m from the preserved surface. X: 4.25 Y: 16.72 Z: -1.00

**Block 51.**

51. Column drum. Edges of the bottom surface broken, top very well preserved. Bottom surface almost half buried to ground, 1 dowel and empolion hole visible. Top surface faces N. 20 flutes. Pres. c. 4/5.

(=D72) Pos: A. Diam_L: 1.458 (1.455–1.461). Diam_U: 1.422 (1.420–1.423). H: 1.474 (1.472–1.476). FIW_L: -. FIW_U: 0.234–0.236. Diam_{UA}: 1.500.

C: On bottom of top flute, 0.04 m from the lower surface. X: 6.30 Y: 14.68 Z: -0.73

52. Column drum fragment. Small piece of upper surface, nothing of the lower. 7 flutes. Pres. c. 1/6.

Pos: B. H: 1.22. FIW_U: 0.228. C: Centre of preserved surface. X: 8.07 Y: 13.93 Z: -0.20

65. Column drum fragment. Top surface partially preserved, 4 flutes. Pres. c. 1/8.

Pos: A. H: c. 1.15. FIW: 0.237.

C: On the SE corner. X: 22.57 Y: 18.40 Z: -0.87

66. Column drum fragment. Some remains of the bottom surface with traces of empolion hole. 7 flutes. Pres. c. 2/5.

Pos: B. H: 1.24. FIW: 0.236.

C: On the edge above the empolion trace. X: 23.20 Y: 18.07 Z: -0.31

72. Column drum fragment. No attachment surfaces, but with an oblique secondary cut. 6 flutes. Pres. c. 1/5.

Pos: F. H: c. 1.40. FIW: 0.19. C: SW corner on top of an arris. X: 28.32 Y: 13.89 Z: -1.13

73. Column drum fragment. Lower surface partially preserved with a dowel hole. 8 flutes. Pres. c. 1/3.

Pos: E. H: c. 1.30. FIW_L: 0.209.

C: Highest point. X: 29.72 Y: 14.23 Z: -0.97

74. Column drum fragment. Small part of the top surface preserved, and perhaps something of the other. 8 flutes. Pres. c. 2/5.

Pos: D. H (complete?): c. 1.40. FIW: 0.218.

C: Highest point. X: 32.33 Y: 14.59 Z: -0.91

75. Column drum fragment. Partially preserved top surface with traces of an empolion and 1 dowel hole. 6 flutes. Pres. c. 1/5.

Pos: E. H: c. 0.80. FIW: 0.202.

C: Empolion. X: 31.19 Y: 15.64 Z: -1.02



Block 77.



Block 80.

77. Column drum. Both surfaces partially preserved, the other with traces of an empolion hole. 10 flutes. Pres. c. 1/2.

(=D75) Pos: F. Diam_L: -. Diam_U: -. H: 1.631 (1.626–1.636). FIW_L: 0.200–0.201. FIW_U: 0.191.

C: Highest point. X: 28.11 Y: 15.67 Z: -0.94

79. Column drum. Half of the lower and upper surfaces visible. Top surface faces SW. 10 flutes. Pres. c. 1/2.

(=D77) Pos: B. Diam_L: 1.426 (1.423–1.429). Diam_U: 1.379 (1.376–1.382). H: 1.482 (1.479–1.485). FIW_L: 0.236. FIW_U: 0.227.

C: SW side on the bottom of the top flute, 0.04 m from the upper surface. X: 30.19 Y: 18.91 Z: -1.02

80. Column drum. Bottom surface almost complete, top slightly broken. Partially buried. Bottom faces SE. Probably 20 flutes. Pres. c. 9/10.

(=D78) Pos: D. Diam_L: 1.331 (1.329–1.333). Diam_U: 1.271 (1.268–1.273). H: 1.708 (1.706–1.709). FIW_L: 0.218–0.219. FIW_U: 0.208. Diam_{LA}: 1.399. Diam_{UA}: 1.333.

C: Highest point, S side on the bottom of the top flute, 0.01 m from the upper surface. X: 33.85 Y: 17.72 Z: -0.44

87. Column drum fragment. Partially preserved top surface with empolion hole. 15 flutes. Pres. c. 2/5.

Pos: F. H: 1.05. FIW: 0.190.

C: Empolion. X: 29.05 Y: 20.28 Z: -0.89



Block 88.

88. Column drum. Both surfaces almost complete. Partially buried. Top surface faces SW. Probably 20 flutes. Pres. c. 1/1.

(=D80) Pos: E. Diam_L: 1.279 (1.277–1.281). Diam_U: 1.216 (1.213–1.218). H: 1.662 (1.660–1.663). FIW_L: 0.208–0.209. FIW_U: 0.198.

C: Highest point, top of an arris in W end. X: 37.25 Y: 17.67 Z: -0.51



Block 89.



Block 90.

89. Column drum. Of the bottom surface only one fourth and of the top less than half presently visible. Top faces N. 9 flutes. Pres. c. 1/2. (=D82) Pos: F. Diam_L: 1.215 (1.212–1.218). Diam_U: 1.158 (1.155–1.161). H: 1.331 (1.326–1.336). FIW_L: –. FIW_U: 0.189–0.190. C: NW corner. X: 42.71 Y: 35.97 Z: -1.22

90. Column drum fragment. Drum presently very fragmentary and largely buried. Clemmensen's measurements cannot be verified. 3 flutes. Pres. c. 2/5. (=D83) Pos: D. Diam_L: 1.326. Diam_U: 1.275. H: 1.415 (1.410–1.420). FIW_L: –. FIW_U: –. C: Highest point, 0.03 m from a flute. X: 44.86 Y: 33.55 Z: -1.34



Block 91.



Block 92.

91. Column drum. Half buried, both surfaces with 1 dowel and empolion hole. Top faces N. 11 flutes. Pres. c. 2/3.
 (=D84) Pos: B. Diam_L: 1.423 (1.420–1.426).
 Diam_U: 1.377 (1.374–1.380). H: 1.469 (1.466–1.472). FIW_L: 0.234. FIW_U: 0.226. Diam_{LA}: 1.49. Diam_{UA}: 1.443.
 C: Bottom of the top flute at NE end. X: 46.94
 Y: 32.69 Z: -1.18

92. Column drum. Bottom surface one third and top less than half buried. Well preserved. Top with empolion and 2 dowel holes, bottom with empolion and 1 dowel hole. Top surface faces NW. Probably 20 flutes. Pres. c. 1/1.
 (=D85) Pos: C. Diam_L: 1.378 (1.375–1.381).
 Diam_U: 1.325 (1.322–1.328). H: 1.643 (1.642–1.644). FIW_L: 0.226. FIW_U: 0.218–0.219.
 Diam_{LA}: 1.451. Diam_{UA}: 1.443.
 C: Bottom of the top flute at W end. X: 47.70
 Y: 33.43 Z: -0.77



Block 93.

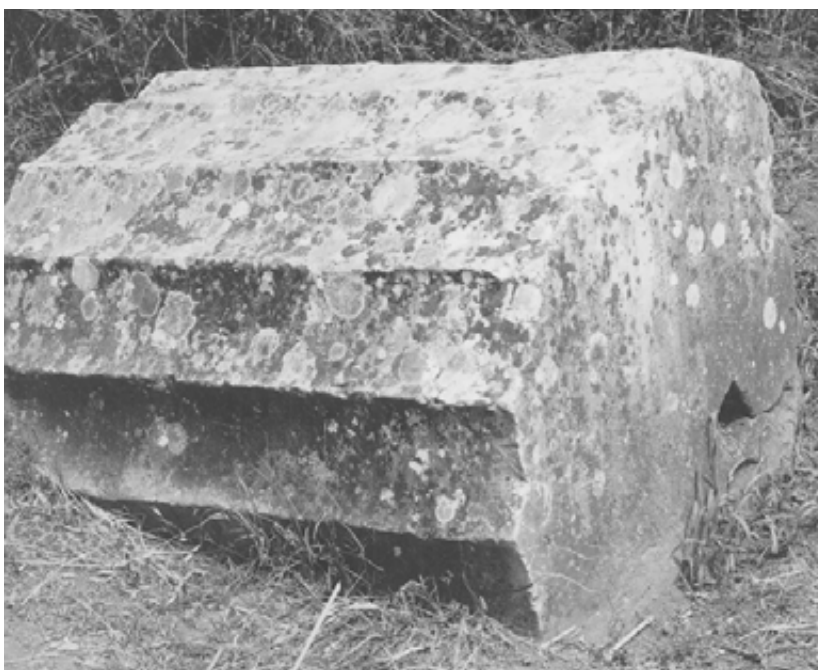

Block 94.

93. Column drum. Bottom surface very largely broken, of the top two thirds visible. Both with empolion and 1 dowel hole. Top faces N. 12 flutes. Pres. c. 4/5.
(=D86) Pos: A. Diam_L: -, Diam_U: 1.426 (1.422–1.430). H: 1.466 (1.461–1.471). FIW_L: -, FIW_U: 0.234–0.236. Diam_{UA}: 1.507.
C: Highest point on the arris at NW end. X: 50.70 Y: 31.77 Z: -0.91

94. Column drum. Of the bottom surface only one third presently visible, of the top more than half, but largely broken. Top with 1 dowel hole and empolion hole. Top faces S. 12 flutes. Pres. c. 2/3.
(=D87) Pos: C. Diam_L: 1.374 (1.371–1.377). Diam_U: 1.328 (1.325–1.331). H: 1.413 (1.410–1.415). FIW_L: 0.227. FIW_U: 0.220. Diam_{UA}: 1.385. C: Highest point on the arris at S end. X: 52.53 Y: 29.34 Z: -0.70



Block 115.

115. Column drum. Bottom surface edges broken on the N side, but completely visible. Top surface one third buried. Matches with block 35 (drum D). Both surfaces with empolion and 2 dowel holes. Bottom surface faces NE. 20 flutes. Pres. c. 1/1.

(=D33) Pos: E. Diam_L: 1.272 (1.269–1.274). Diam_U: 1.210 (1.208–1.212). H: 1.580 (1.578–1.581). FIW_L: 0.208–0.209. FIW_U: 0.200. Diam_{LA}: 1.343. Diam_{UA}: 1.270.

C: Bottom of the top flute on NE side, 0.01 m from the edge. X: 48.42 Y: -0.24 Z: -0.56

121. Column drum fragment. Partially preserved bottom surface. 5 flutes. Pres. c. 1%.

Pos: E. H: 0.53. FIW_L: 0.212.

C: On bottom of the 2nd flute from W on the S side. X: 45.02 Y: -1.63 Z: -1.40

125. Column drum fragment. Partially preserved bottom surface with a dowel hole. 5 flutes visible. Pres. c. 1/8.

Pos: D. H: c. 1.15. FIW_L: 0.218.

C: SW corner. X: 42.47 Y: -3.77 Z: -1.06

126. Pronaos column drum fragment. Partially preserved top surface with empolion and 1 dowel hole. 3 flutes. Deep fluting as in the opisthodomos shaft. Pres. c. 1/10.

H: 0.67. FIW_U: 0.183. Diam_U: c. 1.10 (measured radius c. 0.549).

C: Highest point. X: 43.56 Y: -4.97 Z: -0.76

129. Column drum fragment. Partially preserved bottom surface against the ground. 13 flutes. Pres. c. 1/4.

Pos: F. H: c. 0.90. FIW_L: 0.197.

C: Highest point. X: 45.43 Y: -5.87 Z: -0.74



Block 135.

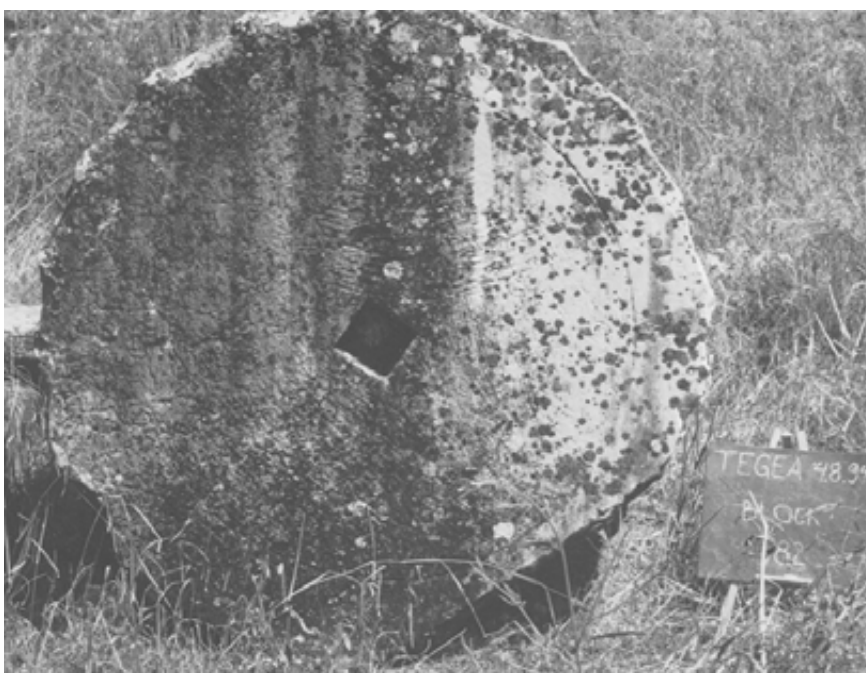

Block 182.

135. Column drum. Bottom surface edges largely broken, but surface completely visible. Of the top one third broken, 1 dowel and empolion hole preserved. Bottom surface faces SE. 16 flutes visible. Pres. c. 9/10.
(=D34) Pos: C. Diam_L: 1.378 (1.376–1.380).

Diam_U: 1.323 (1.320–1.326). H: 1.498 (1.496–1.500). FIW_L: 0.227. FIW_U: 0.219. Diam_{LA}: 1.449. Diam_{UA}: 1.394. C: Top flute, W edge. X: 49.67 Y: -3.70 Z: -0.39

182. Column drum. Almost complete. Identification with D31 very likely because it is the only F drum in the region and it has constant height: likeliest explanation for the height difference is a printing error of 10 cm in Dugas *et al.* 1924, 133. Top surface with only empolion (top drum), bottom with empolion and 2 dowel holes. Bottom faces E. Probably 20 flutes.

Pres. c. 1/1.

(=D31?) Pos: F. Diam_L: 1.209 (1.206–1.212). Diam_U: 1.156 (1.154–1.157). H: 1.479 (1.478–1.480). FIW_L: 0.201. FIW_U: c. 0.191. Diam_{LA}: 1.266. Diam_{UA}: 1.189. C: Top flute, 0.02 m of the W edge. X: 52.63 Y: -14.02 Z: -0.36

318. Column drum fragment. Preserved bottom surface against the ground. 13 flutes. Pres. c. 1/3. Pos: D. H: 1.16. FIW_L: 0.218.

C: Approx. centre of the broken top surface. X: 35.44 Y: -13.15 Z: -0.03

319. Fragment of a small Doric column. See p. 5 n. 19 and A42 for a drawing. (Norman 1984, 180 incorrectly attributes the block to Ionic order). 6 flutes. FIW: 0.078–0.080.

C: On broken top surface, on top of 3rd flute from S. X: 31.62 Y: -9.73 Z: -0.80

341. Column drum fragment. 5 flutes. Pres.

c. 1/5.

Pos: A/B. H: c. 0.94. FIW: 0.236.

C: Upper surface, approx. centre of the broken S edge. X: 24.74 Y: -15.07 Z: -0.22

354. Column drum fragment. 3 flutes. Pres. c. 3%.

Pos: B. H: c. 0.56. FIW: c. 0.230.

C: Highest point. X: 18.63 Y: -16.89 Z: -0.50

356. Column drum fragment. Partially preserved bottom surface. 4 flutes. Pres. c. 1%.

Pos: C. H: 0.42. FIW_L: 0.228.

C: Highest point on the bottom of the flute. X: 18.48 Y: -17.82 Z: -0.77

363. Column drum. Bottom surface with an empolion and 1 dowel hole faces S. Top with an empolion and 2 dowel holes. All edges broken and arrises very worn. Pres. c. 9/10.

(=D37) Pos: C. Diam_L: 1.375 (1.372–1.378). Diam_U: 1.338 (1.335–1.340). H: 1.321 (1.318–1.323). FIW_L: -. FIW_U: 0.221.

C: On bottom of the top flute, at S end. X: 16.89 Y: -14.57 Z: 0.33



Block 363.

369. Column drum fragment. 3 flutes. Pres. c. 3%. Pos: D? H: 0.85. FIW: 0.220.
C: Highest point. X: 14.89 Y: -12.78 Z: -0.66

379. Column drum fragment. 4 + 3 flutes. Pres. c. 1/5. Pos: A. H: c. 0.82. FIW: c. 0.24.
C: Highest point, approx. centre of the block. X: 9.51 Y: -11.37 Z: -0.55

381. Column drum fragment. 2 flutes. Pres. c. 1%. Pos: ? H: c. 0.35.
C: Highest point. X: 7.45 Y: -13.02 Z: -0.96

389. Column drum fragment. Top surface partially preserved. 4 flutes. Pres. c. 2%.
Pos: ? H: 0.414. FIW: -.
C: Highest point. X: 9.32 Y: -14.72 Z: -0.62

390. Column drum fragment. 4 flutes. Pres. c. 1%. Pos: E. H: 0.61. FIW: 0.196.
C: On the 2nd arris from bottom, 0.21 m from N end. X: 11.14 Y: -16.06 Z: -0.91

391. Column drum fragment. 4 flutes. Pres. c. 2%. Pos: B. H: 0.54. FIW: c. 0.233
C: Highest point, S most point. X: 13.25 Y: -15.42 Z: -0.63

394. Column drum fragment. Partially preserved surface. 2 flutes. Pres. c. 3%. H: c. 0.34.
C: SE corner, 0.06 m E from the edge. X: 13.96 Y: -18.80 Z: -0.51

395. Column drum. Largely buried, both surfaces with an empolion and 1 dowel hole. 14 flutes visible. Bottom surface faces NE. Pres. c. 4/5.
(=D40) Pos: B. Diam_L: 1.421 (1.418–1.424).
Diam_U: 1.377 (1.374–1.380). H: 1.474 (1.471–1.477). FIW_L: -. FIW_U: -. Diam_{LA}: 1.465.
C: At the bottom of the flute E of top flute, 0.19 m N end. X: 6.29 Y: -10.31 Z: -0.25

396. Column drum fragment. 10 flutes. Pres. c. 1/3. Pos: C?. H: c. 1.64. FIW: c. 0.22.
C: On top of the flute facing N, on small broken ledge. X: 6.24 Y: -12.42 Z: -0.51

397. Column drum. 10 flutes visible. Pres. c. 9/10.
(=D41) Pos: C. Diam_L: -. Diam_U: -. H: 1.561 (1.556–1.566). FIW_L: -. FIW_U: 0.219.
C: At the bottom of the top flute, 0.01 m of the NE surface. X: 4.65 Y: -12.68 Z: -0.17

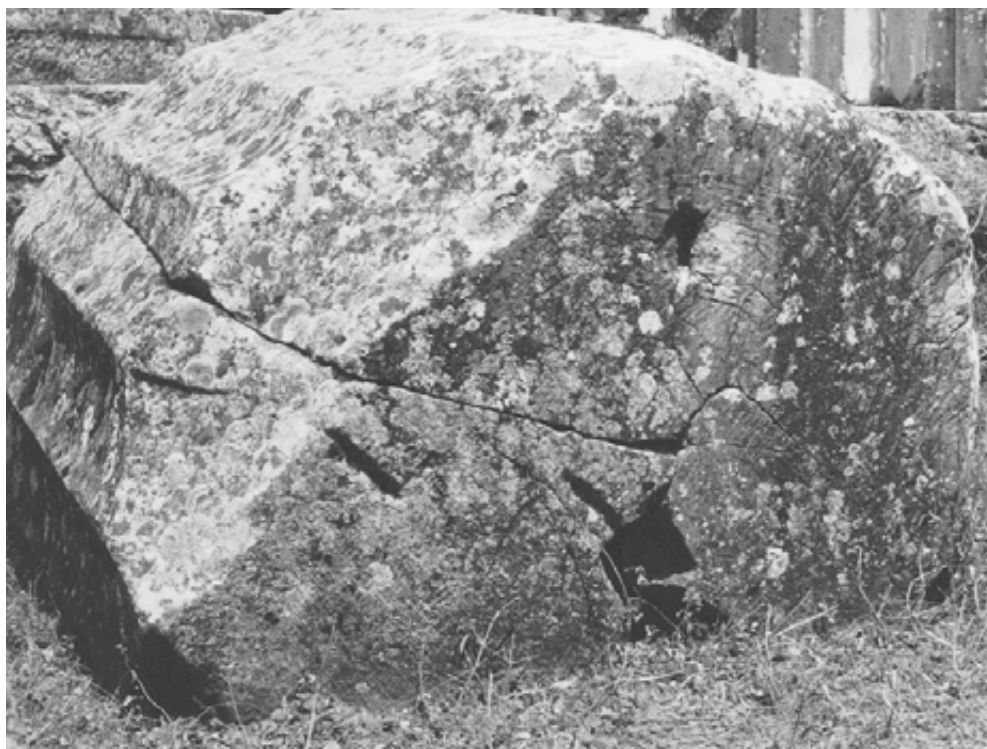

Block 395.

399. Column drum fragment. Bottom surface preserved with a dowel hole. 4 flutes. Pres. c. 1%. Pos: E. H: c. 0.33. FIW_L: 0.210. C: Highest point, E end. X: 2.35 Y: -9.58 Z: -0.86

401. Column drum. Top surface almost complete, bottom half broken (1 dowel and empolion hole). Top faces S. 16 flutes visible,

probably all preserved. Pres. c. 9/10. (=D38) Pos: E. Diam_L: 1.274 (1.271–1.277). Diam_U: 1.216 (1.214–1.218). H: 1.411 (1.408–1.414). FIW_L: -. FIW_U: 0.200. Diam_{LA}: 1.340. Diam_{UA}: 1.277. C: At the bottom of top flute, N end. X: 6.04 Y: -15.65 Z: 0.07



Block 397.



Block 401.



Block 415.

402. Column drum fragment. Partially preserved bottom surface against the ground. 5 flutes. Pres. c. 2%.

Pos: E. H: 0.492. FIW_L: 0.210.

C: At the bottom of top flute, S end. X: 5.53 Y: -15.22 Z: -0.72

410. Column drum fragment. Partially preserved bottom surface against the ground. 8 flutes. Pres. c. 1/6.

Pos: E. H: 1.323. FIW_L: 0.198–0.199.

C: On cracked S surface, 0.54 m above ground and 0.57 m from E edge. X: -0.85 Y: -14.95 Z: -0.71

411. Column drum. A slice broken off the top on the SW side of the drum. Probably preserved bottom surface against the ground. 12 flutes. Pres. c. 1/3.

Pos: D. H: c. 1.33. FIW_L: c. 0.216.

C: Above the flute facing SW, 0.61 m above ground level. X: -1.51 Y: -14.89 Z: -0.63

413. Column drum fragment. Probably preserved top surface against the ground. 6 flutes. Pres. c. 1/10.

Pos: A. H: c. 1.29. FIW_T: 0.237.

C: On a small ledge on broken SE side, 0.33 m above the ground. X: -3.06 Y: -16.01 Z: -0.93

414. Column drum fragment. Both surfaces partially preserved. 4 flutes. Pres. c. 1/5.

Pos: D. H: 1.511. FIW_L: c. 0.216. FIW_U: 0.210.
C: On the bottom of the top flute, S edge. X: -2.93 Y: -15.62 Z: -0.77

415. Column drum. Just slightly more than half of the both surfaces preserved. Opposite flutes buried, no new measurement possible. 11 flutes. Pres. c. 1/2.

(=D44) Pos: D. Diam_L: 1.326 (1.323–1.329).
Diam_U: 1.274 (1.271–1.277). H: 1.447 (1.444–1.450). FIW_L: 0.218–0.220. FIW_U: 0.209.

C: On the bottom of the top flute, NW edge. X: -2.64 Y: -12.24 Z: -0.62

429. Column drum fragment. 3 flutes. Pres. c. 1%. Pos: B. H: c. 0.35. FIW: 0.230.

C: Approx. centre of the block. X: -9.35 Y: -16.03 Z: -0.94

437. Column drum fragment. 2 flutes. Pres. c. 1%. H: c. 0.40. C: Approx. centre of the block. X: -11.57 Y: -16.38 Z: -0.98

452. Column drum fragment. 2 flutes. Pres. c. 3%. H: c. 0.96. C: Bottom of the top flute, E end. X: -15.60 Y: -14.23 Z: -0.84

453. Column drum fragment. 5 flutes. Pres. c. 2%. Pos: B. H: c. 0.60. FIW: 0.234.
C: On broken surface above the 2nd arris from N. X: -15.32 Y: -12.46 Z: -0.93

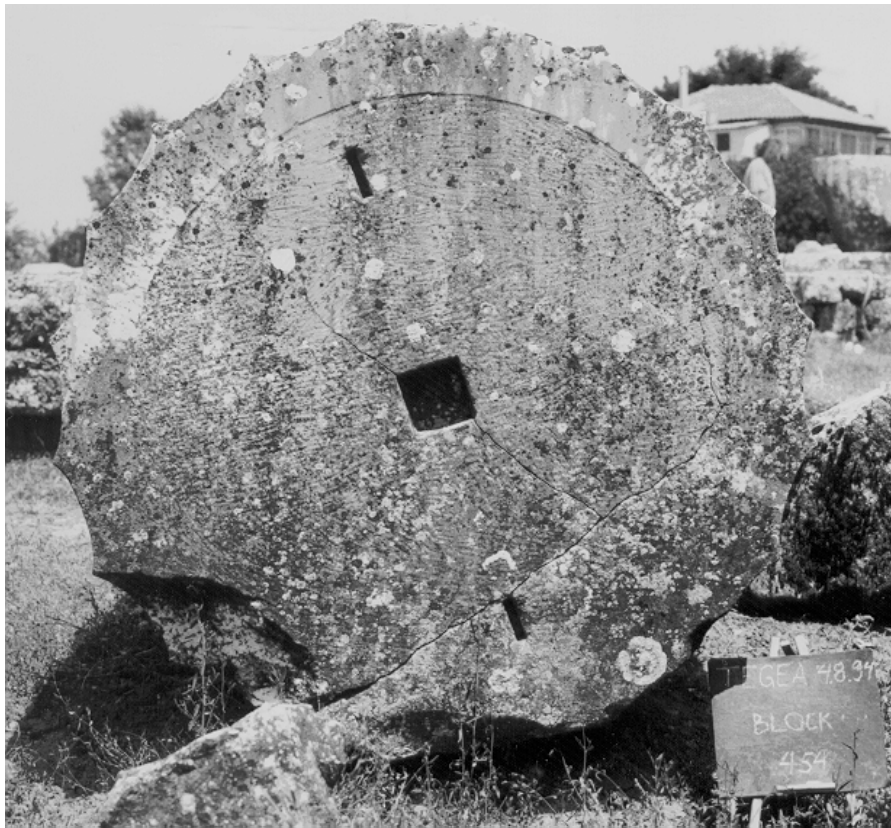

Block 454.

454. Column drum. Both surfaces almost complete. Top faces E. 20 flutes. Pres. c. 1/1.

(=D47) Pos: E. Diam_L: 1.268 (1.265–1.270). Diam_U: 1.212 (1.211–1.213). H: 1.368 (1.367–1.369). FIW_L: 0.206–0.208. FIW_U: 0.199–0.201. Diam_{LA}: 1.336. Diam_{UA}: 1.273.

C: Bottom of the top flute, E end. X: -15.99 Y: -11.62 Z: -0.12

455. Column drum. Top of the drum preserved, bottom completely broken off. Probably 20 flutes. 1 dowel remaining in original position. Pres. c. 1/2.

(=D46) Pos: D. Diam_L: -. Diam_U: 1.267 (1.264–1.270). H: -. FIW_L: -. FIW_U: 0.210–0.212. Diam_{UA}: 1.341.

C: Bottom of the top flute, N end. X: -17.53 Y: -13.41 Z: -0.05



Block 455.

456. Column drum. Top surface with an empolion hole, 1 complete and 1 fragmentary dowel hole. 10 flutes. Pres. c. 3/5. Pos: A. H: c. 1.42. FIW_U: 0.236. C: Empolion. X: -16.54 Y: -16.45 Z: 0.08

457. Column drum fragment. Bottom surface partially preserved with a dowel hole. 6 flutes. Pres. c. 3%. Pos: D. H: c. 0.80. FIW_L: 0.218. C: On top surface above the dowel hole. X: -17.53 Y: -17.33 Z: -0.59

461. Column drum fragment. 3 flutes. Pres. c. 2%. Pos: D. H: c. 0.58. FIW: 0.214. C: On top of the N flute. X: -23.87 Y: -17.72 Z: -0.86

464. Column drum fragment. 3 flutes. Pres. c. 1%. Pos: E. H: c. 0.35. FIW: 0.205. C: N corner. X: -20.69 Y: -16.78 Z: -0.77

470. Column drum fragment. 3 flutes. Pres. c. 1%. Pos: E. H: c. 0.42. FIW: 0.204. C: Above the N flute, highest point. X: -18.54 Y: -13.67 Z: -0.86

471. Column drum fragment. 3 flutes. Pres. c. 1%. Pos: E. H: 0.46. FIW: 0.204. C: Top arris, highest point. X: -18.27 Y: -12.49 Z: -1.01

472. Column drum fragment. 2 + 3 flutes visible. Top and bottom surfaces partially remaining, bottom with 1 dowel hole. Pres. c. 1/3. Pos: C. H: 1.55. FIW: 0.226. C: Highest point. X: -21.66 Y: -14.12 Z: -0.41

476. Half-column fragment. Fits the upper part of the Corinthian half column from the cella. 6 flutes. H: 0.32 FIW: 0.100. C: E side. X: -25.79 Y: -17.56 Z: -0.93

478. Column drum fragment. Partially preserved top surface. 3 flutes. Pres. c. 1%. Pos: F. H: 0.360. FIW_U: 0.189. C: Approx. centre of the fragment. X: -26.40 Y: -16.21 Z: -1.06

483. Column drum fragment. 2 flutes. Pres. c. 1%. H: c. 0.54. C: Highest point. X: -20.39 Y: -12.50 Z: -0.80

484. Column drum fragment. Partially preserved bottom surface. 4 flutes. Pres. c. 1%. Pos: E. H: c. 0.415. FIW_L: 0.209. C: Above the N most flute. X: -20.85 Y: -12.18 Z: -0.93

486. Column drum fragment. Partially preserved bottom surface. 9 flutes. Pres. c. 1/3. Pos: E. H: 0.999. FIW_L: 0.210. C: Bottom of the top flute, highest point. X: -20.35 Y: -11.79 Z: -0.41

487. Column drum. Drum broken in two halves, the other half is drum 495. Bottom surface mostly preserved with empolion and 2 dowel holes. 5 + 4 flutes. Pres. c. 2/5. Pos: A. Diam_L: c. 1.45. H (combined with 495): c. 1.47. FIW_L: c. 0.240. C: S edge of the drum, directly above the empolion. X: -19.14 Y: -11.26 Z: -0.12

490. Column drum. Small fragment of the of the bottom surface preserved, of the top slightly more. 7 + 6 flutes. Pres. c. 2/3. Pos: E. H: 1.438. FIW_L: 0.198. C: W edge of the drum, at the NW corner of the preserved surface. X: -28.17 Y: -9.01 Z: -0.87

492. Column drum. Bottom surface half visible (1 dowel and empolion hole), top almost complete. Top faces E. 14 flutes. Pres. c. 9/10. (=D51) Pos: D. Diam_L: *1.321* (1.318–1.324). Diam_U: 1.268 (1.266–1.270). H: 1.448 (1.446–1.450). FIW_L: 0.215–0.217. FIW_U: 0.209. Diam_{UA}: 1.335. C: Top arris, E end. X: -27.11 Y: -7.12 Z: -0.37

495. Column drum. Drum broken in two halves, the other half is drum 487. Top surface mostly preserved with empolion and dowel hole. 5 + 3 flutes visible. Pres. c. 1/2. Pos: A. Diam_U: c. 1.42. H (combined with 487): c. 1.47. C: NE edge of the drum, directly above the empolion. X: -19.48 Y: -8.02 Z: -0.22

497. Column drum. Both surfaces badly broken, but measurements possible to take (both with 1 dowel and empolion hole). Top surface faces E. 8 flutes visible. Pres. c. 2/3.

Pos: E. Diam_L: 1.268 (1.265–1.271). Diam_U: 1.218 (1.215–1.221). H: 1.347 (1.344–1.350). FIW_L: 0.208. FIW_U: 0.198.
C: Empolion. X: -22.55 Y: -3.00 Z: -0.85



Block 492.



Block 497.



Block 498.



Block 506.

**Block 507.**

498. Column drum. Top surface less than half preserved, bottom more than half. Both with empolion and 1 dowel hole. Bottom faces N. 13 flutes visible. Pres. c. 4/5.

Pos: B. Diam_L: 1.420 (1.417–1.423). Diam_U: 1.370 (1.367–1.373). H: 1.484 (1.481–1.486). FIW_L: 0.233–0.235. FIW_U: 0.227–0.235. Diam_{LA}: 1.478.

C: S edge of the drum, directly above the empolion. X: -24.37 Y: -5.40 Z: -0.13

502. Column drum fragment. Top surface partially preserved with empolion but no dowel holes. 3 flutes visible. Pres. c. 1/10.

Pos: F. H: c. 0.45. FIW_U: 0.190.

C: Empolion. X: -31.99 Y: -5.20 Z: -0.90

506. Column drum. Both surfaces well preserved. Bottom faces NE. Pres. c. 1/1.

Pos: C. Diam_L: 1.379 (1.377–1.380). Diam_U: 1.329 (1.327–1.330). H: 1.510 (1.508–1.512). FIW_L: 0.225–0.228. FIW_U: 0.218–0.221. Diam_{LA}: 1.454. Diam_{UA}: 1.400.

C: Bottom of the top flute, N edge. X: -27.06 Y: -1.42 Z: -0.14

507. Column drum. Top surface well preserved (with only empolion; top drum), bottom mostly broken (no holes). Top faces SW.

Probably 20 flutes. Pres. c. 4/5.

(=D53) Pos: F. Diam_L: 1.206 (1.202–1.210). Diam_U: 1.155 (1.152–1.158). H: 1.349 (1.343–1.353). FIW_L: 0.199–0.200. FIW_U: 0.190–0.191. C: Bottom of the top flute, NE edge. X: -29.48 Y: -2.45 Z: -0.37

509. Column drum. Bottom surface completely preserved. Probably 20 flutes. Pres. c. 2/3.

Pos: F. Diam_L: 1.220. H: 0.951. FIW_L: 0.200–0.201.

C: Bottom of the top flute, SE edge. X: -31.24 Y: -2.48 Z: -0.39

510. Column drum. Built partly into a wall. Possibly both surfaces nearly complete. Bottom faces NE. Pres. c. 9/10.

Pos: E. H: 1.522. FIW_L: 0.208–0.209. FIW_U: 0.199–0.200.

C: Bottom of the top flute, S edge. X: -32.44 Y: -1.28 Z: -0.42



Block 529.



Block 533.

511. Column drum fragment. 5 flutes. Pres. c. 1/10. Pos: A. H: 0.996. FIW: c. 0.237–0.238. C: N end of the top arris. X: -29.73 Y: -1.63 Z: -0.86

512. Column drum. Top surface preserved. 20 flutes. Pres. c. 2/3. Pos: B. H: c. 1.01. FIW_T: 0.228–0.230. C: Approx. centre of the broken upper surface. X: -28.44 Y: -0.74 Z: -0.52

523. Column drum fragment. Top surface 1/4 preserved with empolion cutting, bottom very fragmentarily preserved. 6 flutes. Pres. c. 1/4. Pos: A. H: 1.474. FIW_T: 0.236. C: Bottom of the top flute, N edge of the preserved surface. X: -17.24 Y: 1.55 Z: -0.44

525. Column drum fragment. Top surface partially preserved. 8 flutes. Pres. c. 1/5. Pos: A. H: c. 1.305. FIW_T: 0.236. C: Upper surface, above the NW most arris. X: -14.74 Y: 0.62 Z: -0.04

527. Opisthodomos column drum. Bottom surface preserved empolion cutting and dowel hole. Fluting too deep for exterior order (depth 34 mm, in ext. order with same flute width the depth is c. 26–27 mm). 6 flutes. Pres. c. 1/2. H: 1.236. FIW: 0.201. C: Bottom of the top flute, N edge. X: -14.15 Y: 2.55 Z: -0.26

528. Opisthodomos column drum. Top surface against the ground, probably completely preserved. 20 flutes. Pres. c. 2/3. Diam_U: 1.150. FIW_U: 0.190–0.193. C: Highest point, NW corner. X: -13.93 Y: 4.18 Z: -0.10

529. Column drum. Bottom surface almost complete, a small segment broken off the top surface. Both with empolion and 2 dowel holes. Bottom surface faces N. Apparently 20 flutes. Pres. c. 1/1. Pos: B. Diam_L: 1.418 (1.416–1.420). Diam_U: 1.376 (1.374–1.378). H: 1.473 (1.470–1.475). FIW_L: 0.232–0.234. FIW_U: 0.226–0.228. Diam_{LA}: 1.490. Diam_{UA}: 1.445. C: Bottom of the top flute, N edge. X: -15.40 Y: 3.35 Z: -0.06

533. Column drum. Edges of the top surface broken, a small segment broken off the top surface. Both with 2 dowel holes and empolion (other dowel hole on bottom partially broken). Top faces SE. Apparently 20 flutes. Pres. c. 1/1. Pos: E. Diam_L: 1.274 (1.272–1.276). Diam_U: 1.223 (1.221–1.225). H: 1.356 (1.354–1.358). FIW_L: 0.209–0.210. FIW_U: c. 0.200. Diam_{LA}: 1.339. Diam_{UA}: 1.280. C: Bottom of the top flute, NW edge. X: -22.17 Y: 1.48 Z: -0.19

536. Column drum fragment. Bottom surface partially preserved. 3 flutes. Pres. c. 4%. Pos: A. H: c. 0.79. FIW_L: 0.239. C: Highest point next to the preserved top surface. X: -28.64 Y: 0.96 Z: -0.84

538. Column drum fragment. Top surface partially preserved with dowel hole. 3 flutes. Pres. c. 2%. Pos: A. H: 0.504. FIW_T: 0.234. C: S end of the top arris. X: -30.47 Y: 2.80 Z: -0.90

541. Column drum fragment. Bottom surface partially preserved. 6 flutes. Pres. c. 1/6. Pos: B. H: 0.595. FIW_L: 0.233. C: Bottom of the top flute, SW end. X: -23.79 Y: 2.47 Z: -0.75



Block 542.

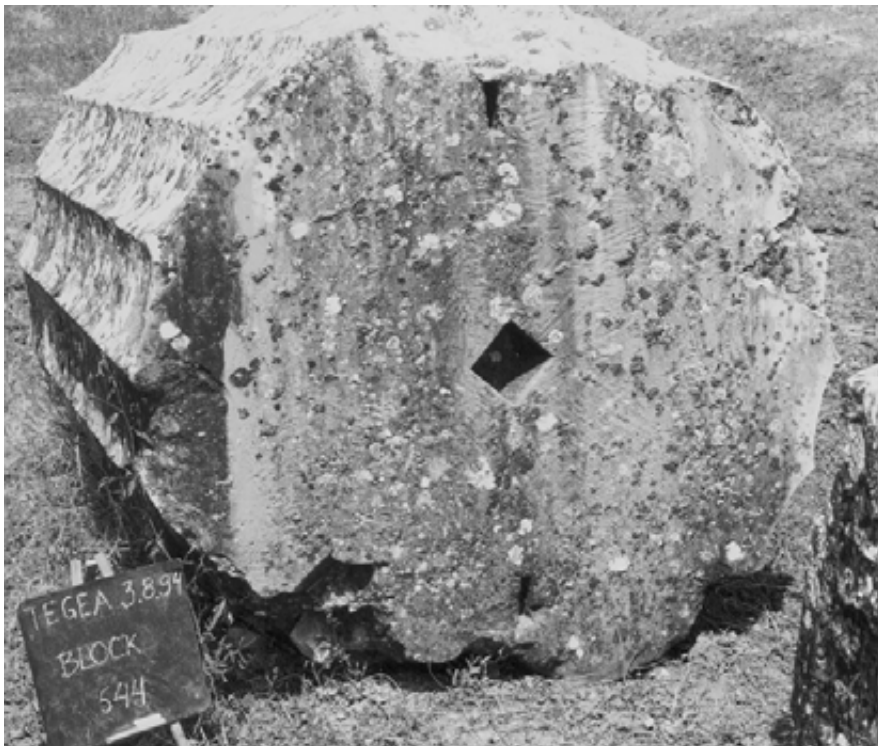

Block 544.



Block 561.

542. Column drum. Anathyrosis rim broken on both surfaces. Top surface with only empolion hole (top drum), bottom with 1 dowel and empolion hole. 11 flutes. Pres. c. 2/3. (=D65) Pos: F. Diam_L: 1.220 (1.218–1.222). Diam_U: 1.154 (1.151–1.157). H: 1.500 (1.497–1.505). FIW_L: 0.198–0.201. FIW_U: 0.189–0.192. C: Bottom of the top flute, NW end. X: -22.43 Y: 3.45 Z: -0.74

544. Column drum. Bottom surface well preserved (empolion and 2 dowel holes), edges of the top surface broken (top drum, only empolion hole). Bottom surface faces S. Apparently 20 flutes. Pres. c. 1/1. (=D66) Pos: F. Diam_L: 1.215 (1.213–1.217). Diam_U: 1.158 (1.155–1.161). H: 1.484 (1.479–1.488). FIW_L: 0.199–0.200. FIW_U: 0.190–0.192. Diam_{LA}: 1.275. Diam_{UA}: 1.209. C: Bottom of the top flute, S end of the preserved surface. X: -24.81 Y: 4.32 Z: -0.23

555. Opisthodomos column drum. Edges of the top surface partially broken, otherwise both surfaces fairly complete with empolion and 2

dowel holes. Apparently 20 flutes. Pres. c. 1/1. Diam_L: 1.094. Diam_U: 1.043. H: 1.547. FIW_L: 0.179–0.183. FIW_U: 0.172–0.173. Diam_{LA}: 1.164. Diam_{UA}: 1.105. C: Bottom of the top flute, SE end. X: -14.46 Y: 9.29 Z: -0.21

560. Column drum fragment. Bottom surface probably pres. against the ground. 4 + 5 flutes. Pres. c. 2/5. Pos: A. Diam_L: c. 1.44. H: c. 0.98. FIW_L: 0.242–0.244. C: On broken surface, on top of W most flute. X: -15.15 Y: 12.80 Z: -0.53

561. Column drum. A small segment broken off the top surface (empolion and 2 dowel holes), bottom badly broken (empolion and dowel hole). Top faces W. 16 flutes. Pres. c. 3/4. Pos: B. Diam_L: 1.417 (1.414–1.420). Diam_U: 1.374 (1.371–1.377). H: 1.477 (1.475–1.479). FIW_L: 0.234. FIW_U: 0.226–0.227. Diam_{UA}: 1.447. C: On bottom of top flute, W end. X: -16.80 Y: 14.06 Z: -0.05



Block 563.



Block 564.

563. Column drum. Drum slightly more than half preserved. Top with empolion and 2 dowel holes, bottom with empolion and 1 dowel hole. Top faces S. 13 flutes. Pres. c. 1/2.

(=D70) Pos: B. Diam_L: 1.418 (1.416–1.420). Diam_U: 1.377 (1.374–1.380). H: 1.478 (1.476–1.480). FIW_L: 0.234. FIW_U: 0.225–0.228. Diam_{LA}: 1.490. Diam_{UA}: 1.452.

C: On bottom of top flute, N end. X: -14.28 Y: 15.86 Z: -0.54

564. Column drum. Top surface one fourth buried, but apparently complete (empolion and dowel hole), edges of the bottom broken, otherwise complete (empolion and 2 dowel holes). Bottom faces SE. Probably 20 flutes. Pres. c. 1/1.

(=D71) Pos: A. Diam_L: 1.455 (1.452–1.458). Diam_U: 1.416 (1.413–1.419). H: 1.472 (1.469–1.474). FIW_L: -. FIW_U: 0.233–0.235. Diam_{LA}: 1.52. Diam_{UA}: 1.471.

C: On bottom of top flute, NW end. X: -9.37 Y: 17.04 Z: 0.04

727. Column drum fragment. 7 flutes. Pres. c. 2%. Pos: F. H: c. 0.29. FIW: 0.194. C: Highest point above the flute facing N. X: 50.70 Y: -27.38 Z: -0.22

741. Column drum fragment. 5 flutes. Pres. c. 1/10. Pos: D/E. H: c. 0.83. FIW: 0.211. C: NE corner of the broken top surface. X: 47.99 Y: -24.45 Z: -0.31

743. Column drum fragment. Top surface partially preserved. 6 flutes. Pres. c. 1/5. Pos: D. H: 1.31. FIW_U: 0.210. C: Bottom of the top flute, E end. X: 49.68 Y: -23.97 Z: -0.47

807. Column drum fragment. 4 flutes. One surface with dowel hole and empolion cutting partially preserved, but too little remains to determine whether it is the top or bottom. Fluting too shallow for porch order. Pres. c. 1/4. Pos: F. H: c. 1.23. FIW: c. 0.193. C: Highest point. X: 20.41 Y: 19.92 Z: -1.16



Block 809.

809. Column drum. Top surface one third buried but probably complete (empolion and 2 dowel holes). Bottom more than half broken with 1 dowel hole. Arris repaired on the top flute and also at the NE corner of the drum a rectangular cut for arris repair (see p. 29). 14 flutes. Pres. c. 4/5. Pos: C. Diam_L: 1.365 (1.360–1.370). Diam_U: 1.332 (1.330–1.334). H: 1.457 (1.454–1.459). FIW_L: 0.226. FIW_U: 0.219–0.220. Diam_{UA}: 1.405. C: Bottom of the top flute, N end. X: 19.41 Y: 22.31 Z: -1.07

813. Pronaos column drum fragment. 3 flutes. Fluting seems shallower than in the other porch order drums, but this could be due to broken arrises. Pres. c. 1%. H (visible): c. 0.40. FIW: 0.178. C: Bottom of the top flute, W end. X: 20.48 Y: 33.31 Z: -1.05

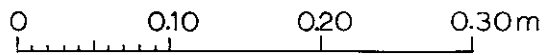
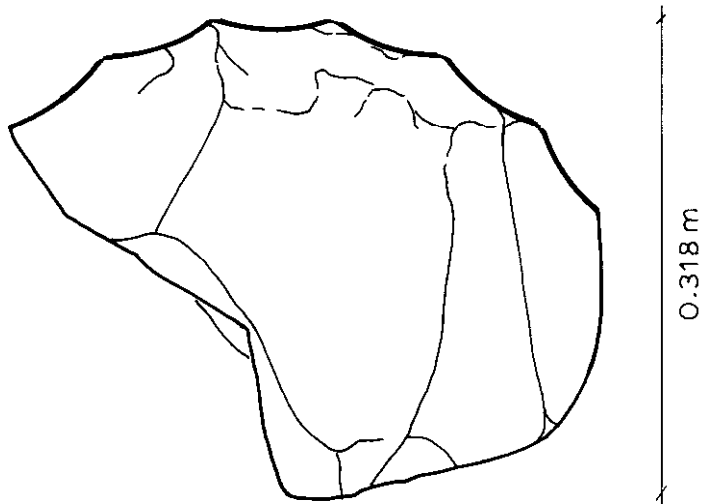
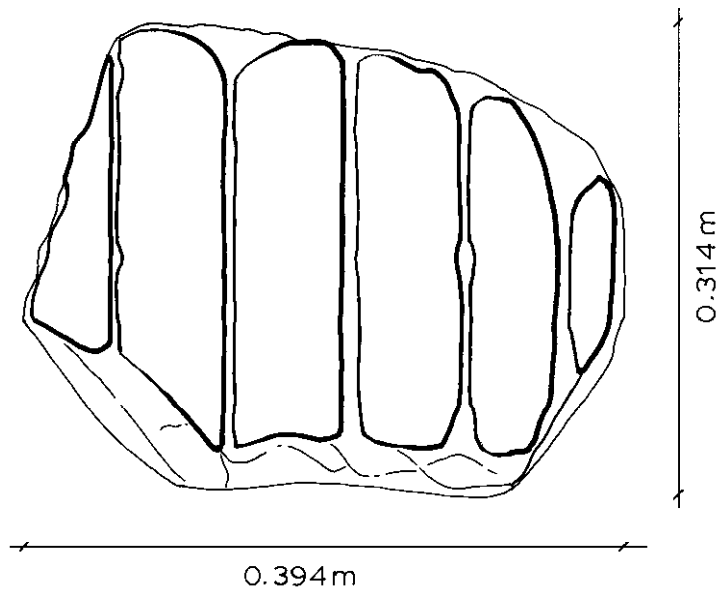

319. Fragment of a small Doric column.

Scale 1:5. On the block, see p. A27.

Drawing by A. Hooton based on a field-drawing by J. P.

Schematic Drawings of Empolion and Dowel Holes
Scale 1:30 (original scale 1:25)

Drums A – Top Surfaces

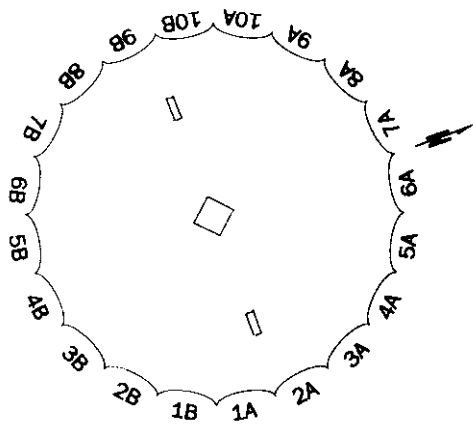

Block 8

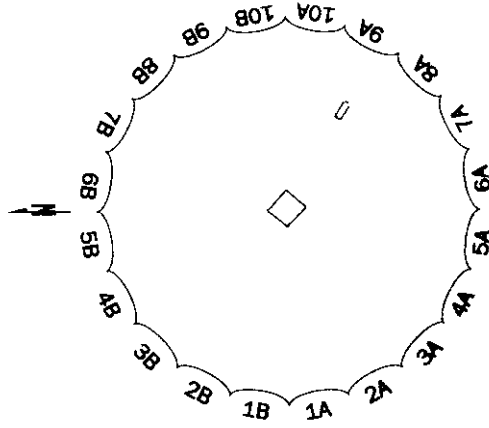

Block 21

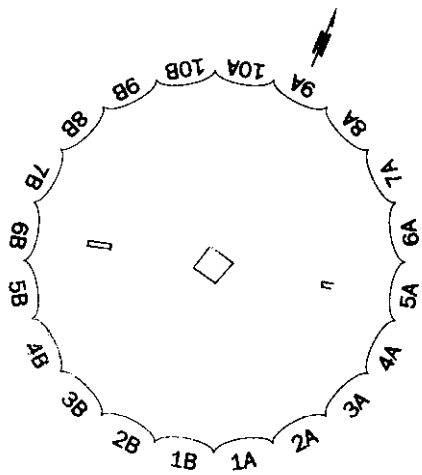

Block 47

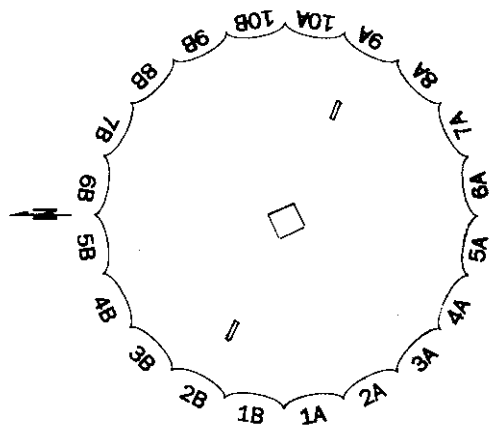

Block 48

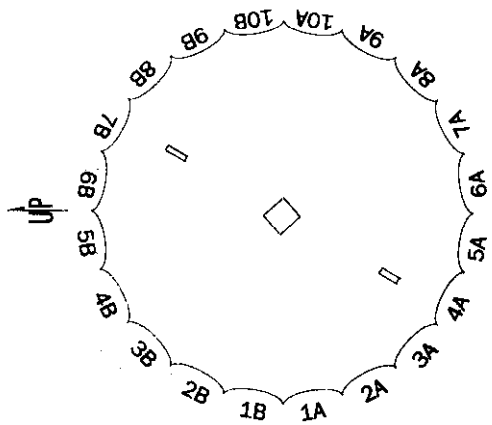

Block 51

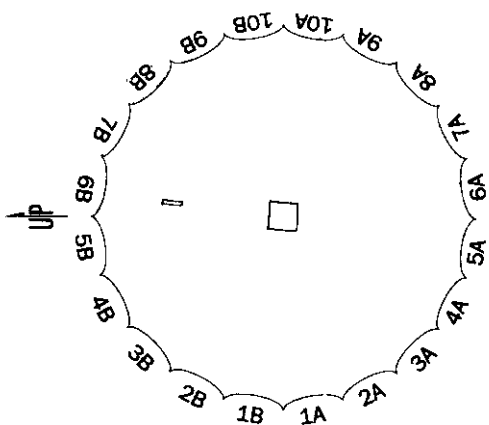

Block 93

Drums A – Top Surfaces

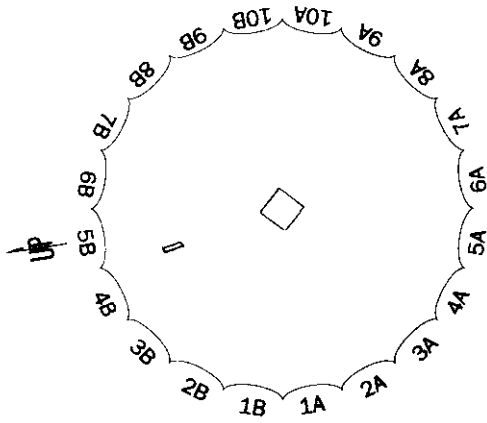

Block 564

Drums B – Bottom Surfaces

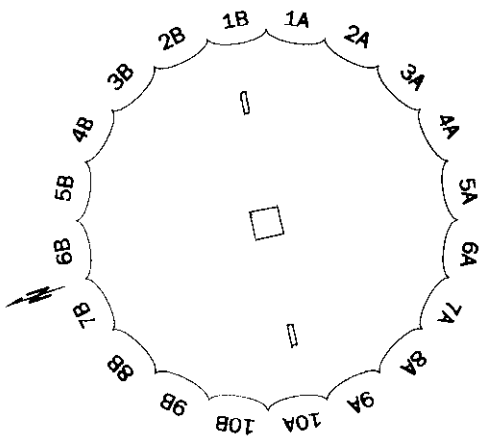

Block 3

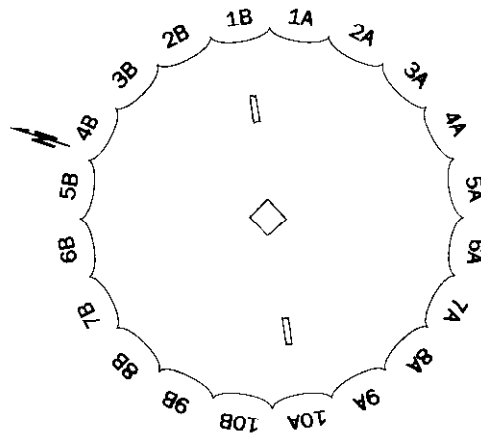

Block 6

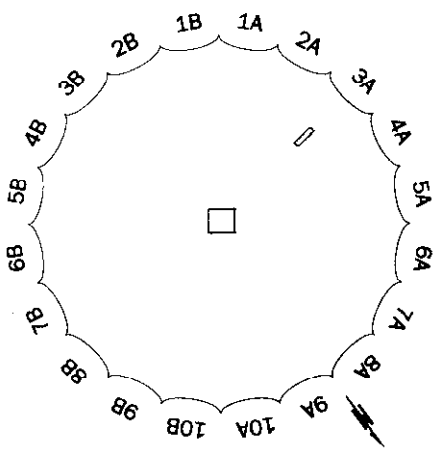

Block 24

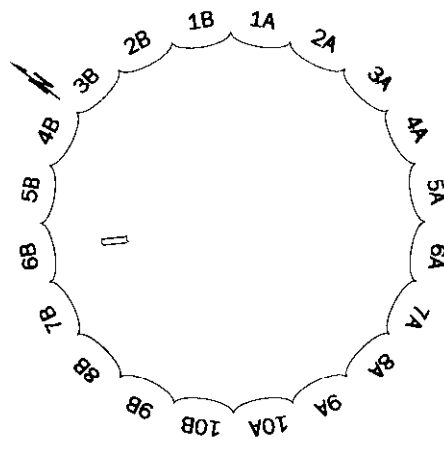

Block 36

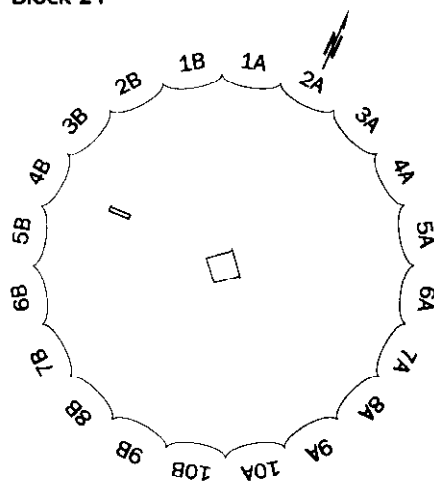

Block 45

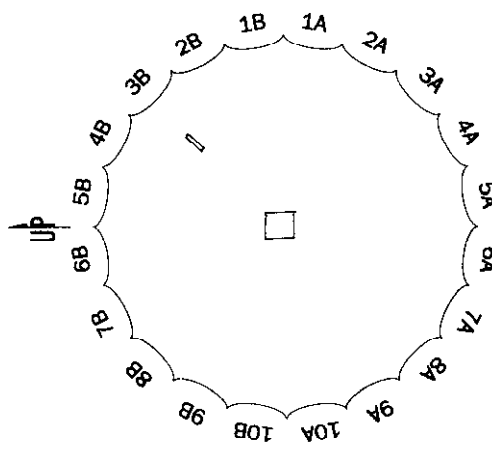

Block 91

Drums B – Bottom Surfaces

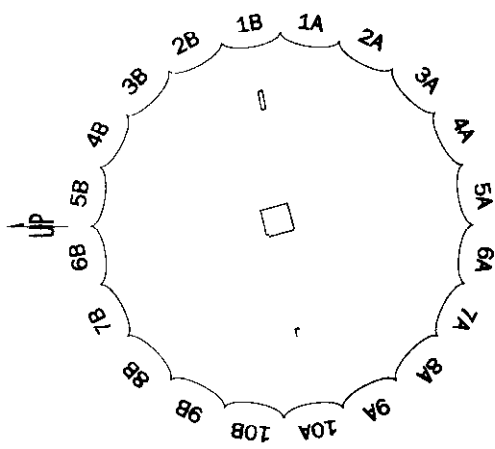

Block 395

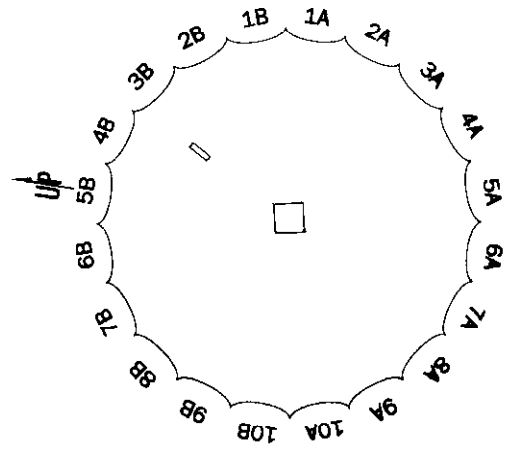

Block 498

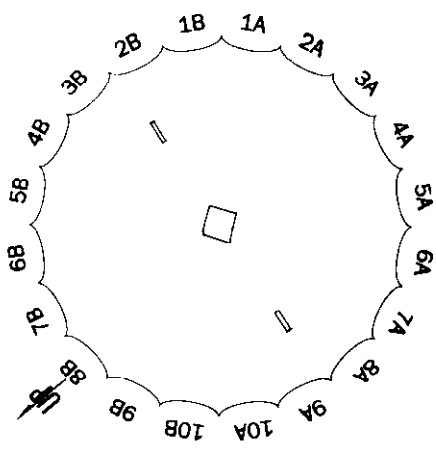

Block 529

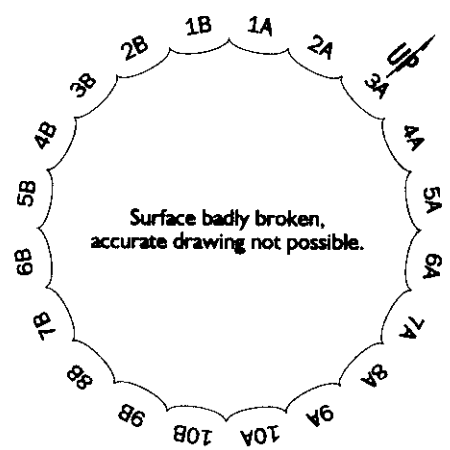

Block 561

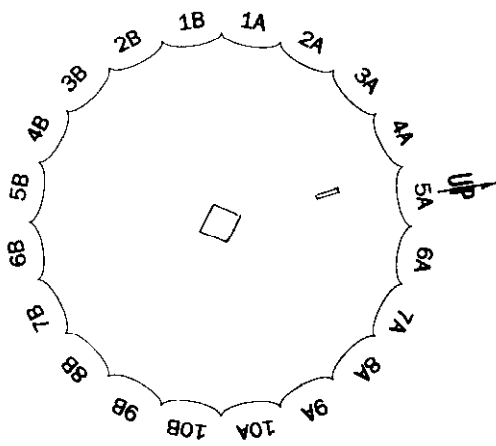

Block 563

Drums B – Top Surfaces

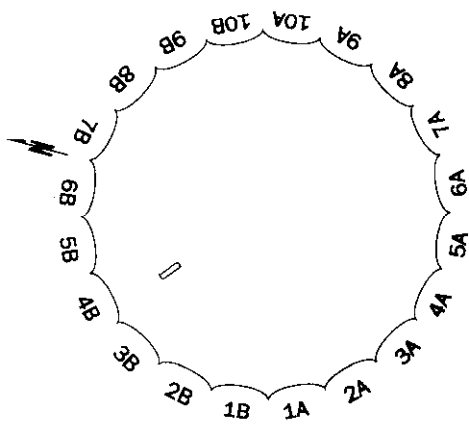

Block 3

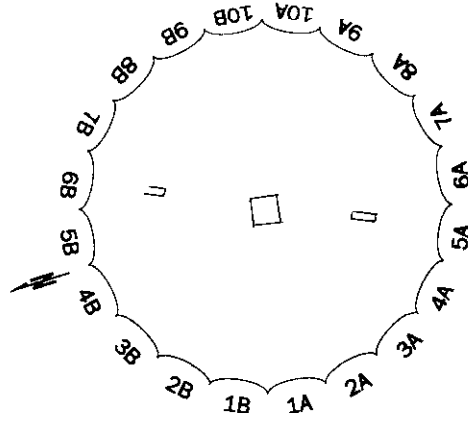

Block 6

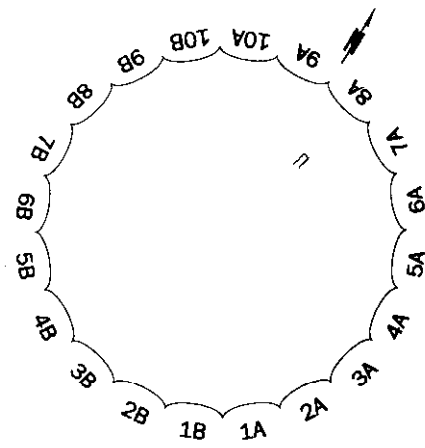

Block 24

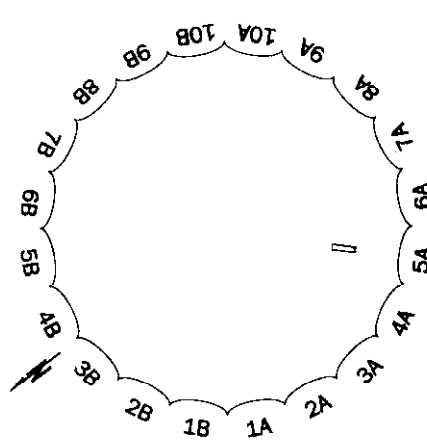

Block 36

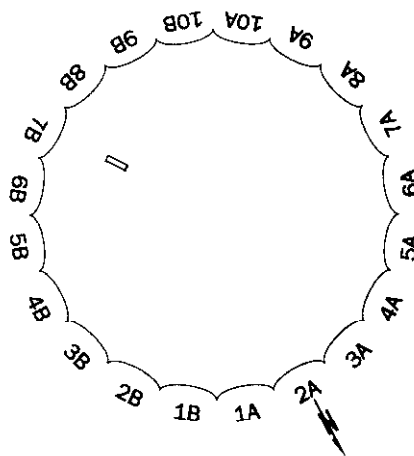

Block 45

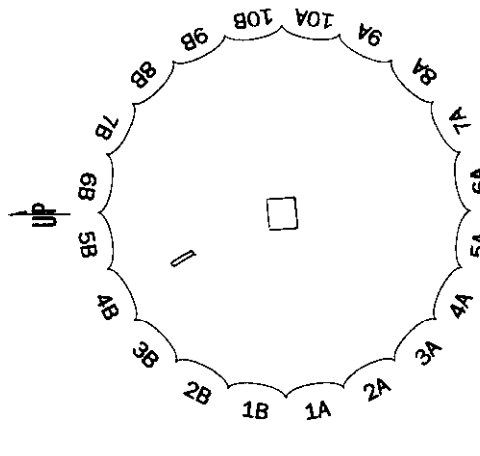

Block 91

Drums B – Top Surfaces

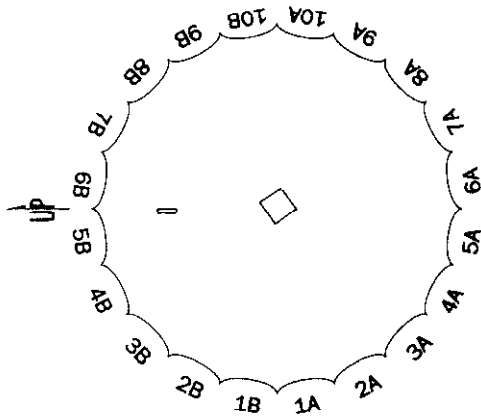

Block 395

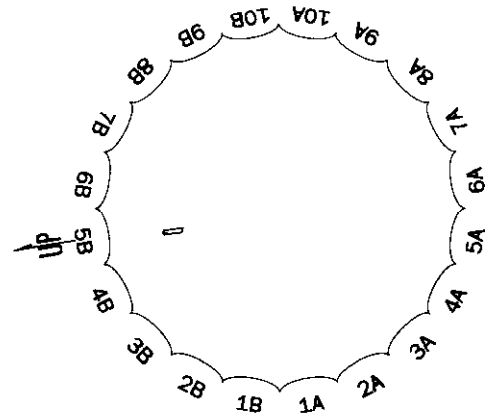

Block 498

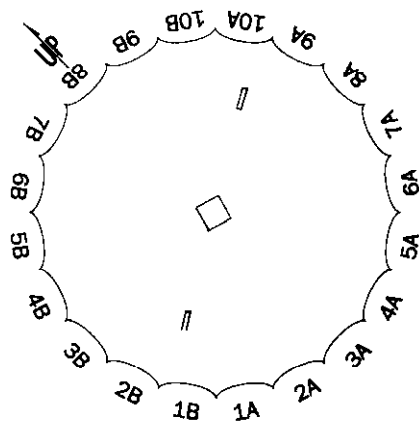

Block 529

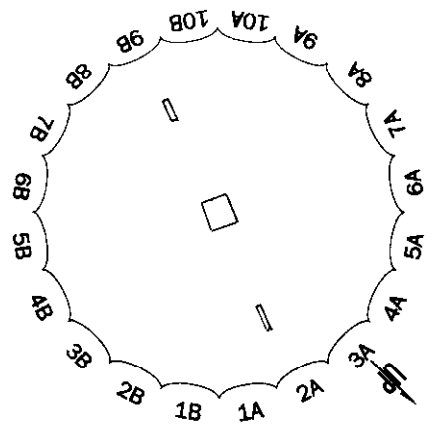

Block 561

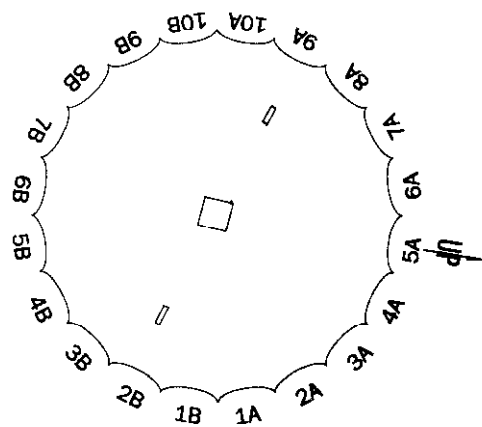

Block 563

Drums C – Bottom Surfaces

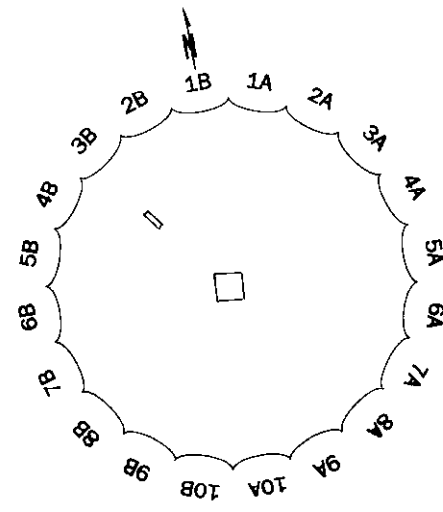
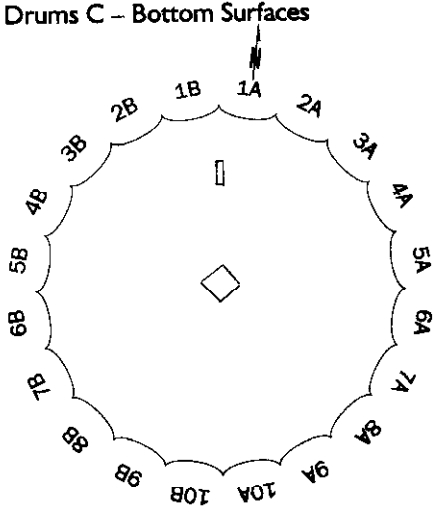

Block 9

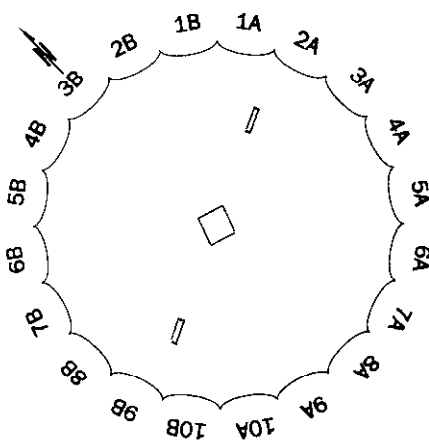

Block 15

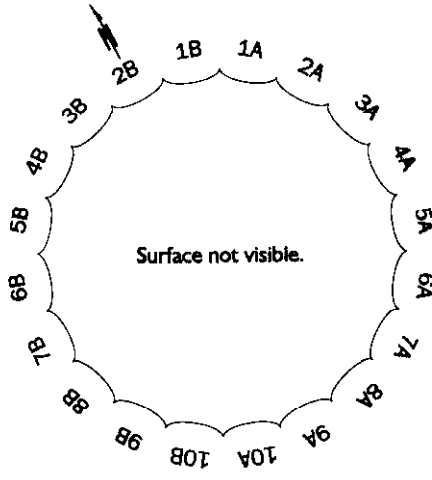

Block 27

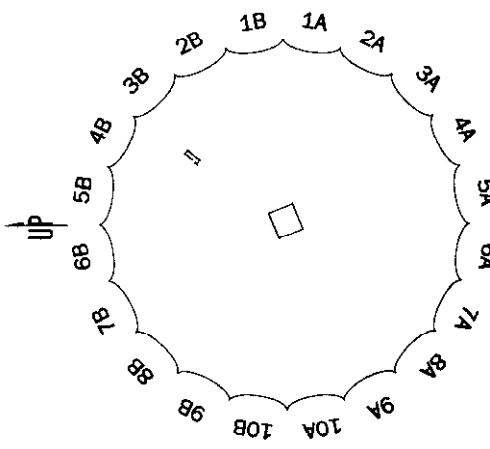

Block 46

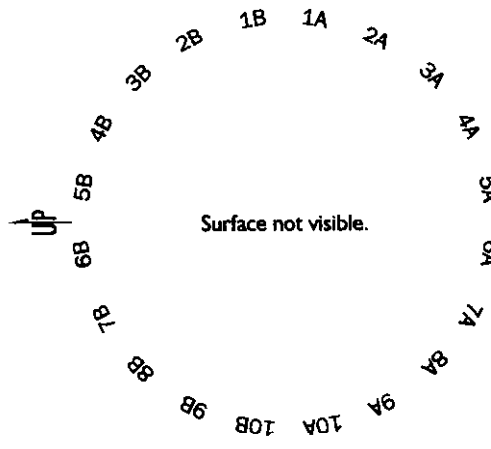

Block 92

Block 94

Drums C – Bottom Surfaces

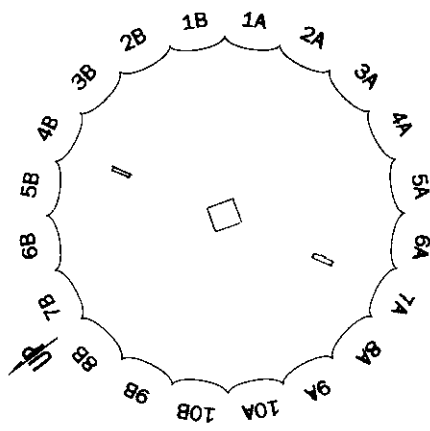

Block 135

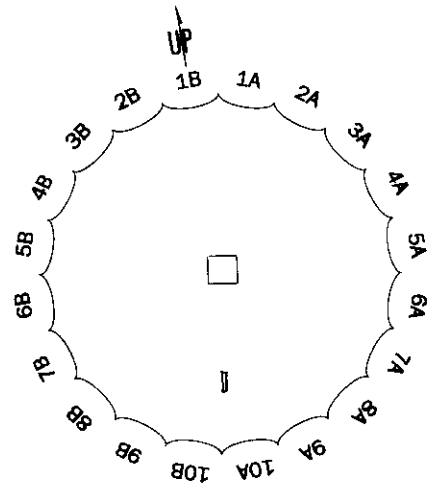

Block 363

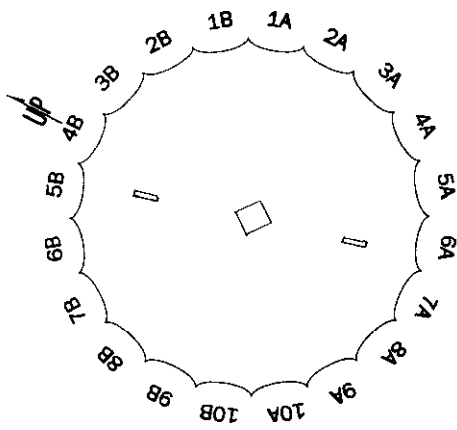

Block 506

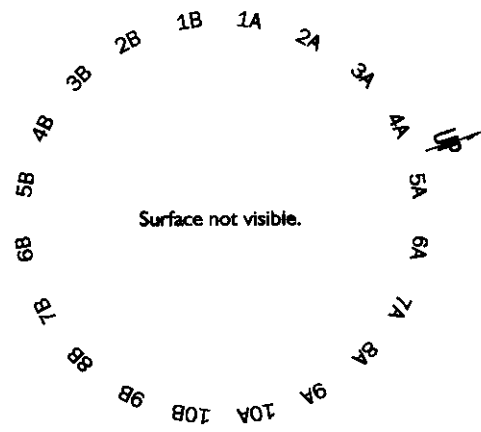

Block 809

Drums C – Top Surfaces

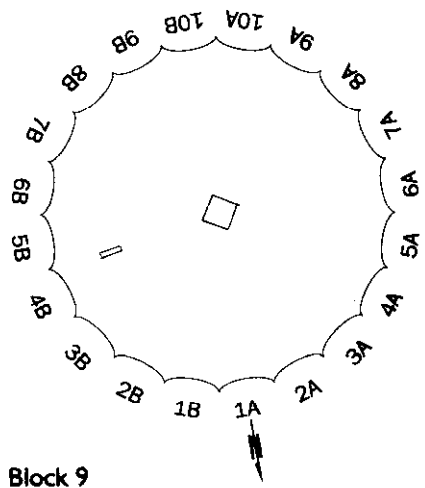

Block 9

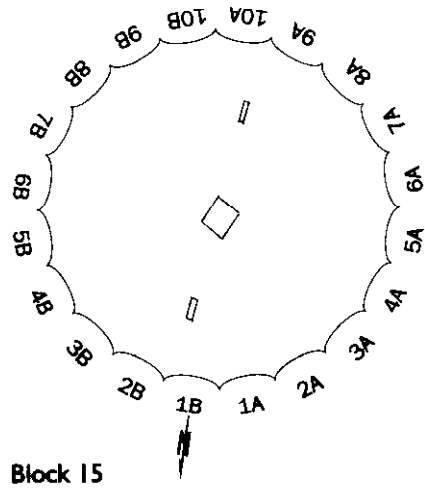

Block 15

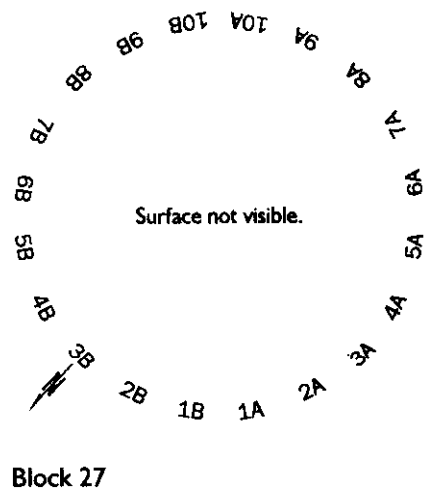

Block 27

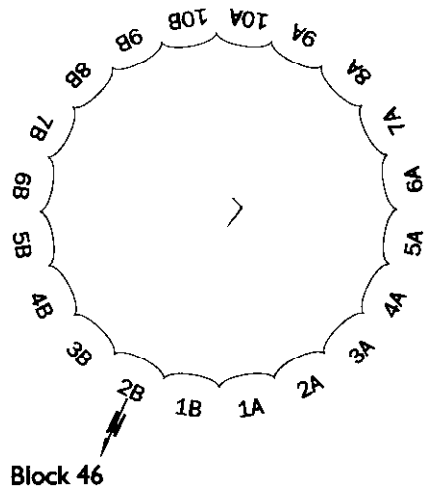

Block 46

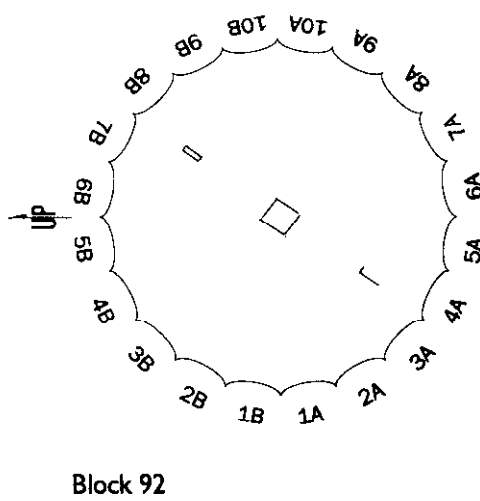

Block 92

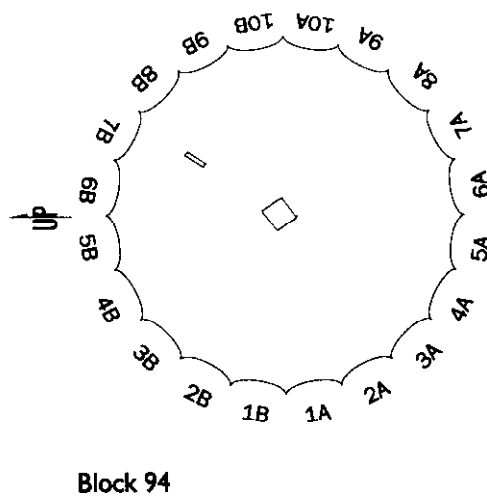

Block 94

Drums C -- Top Surfaces

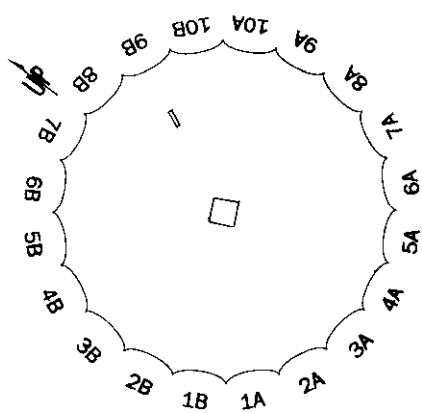

Block 135

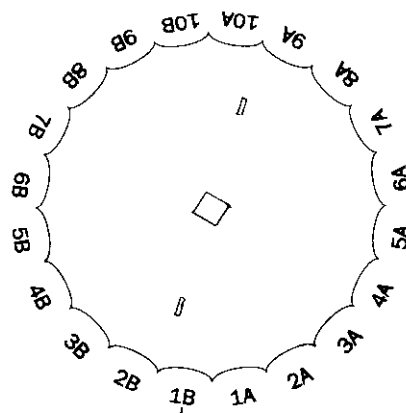

Block 363

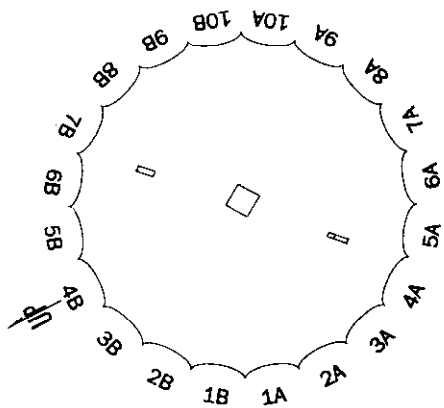

Block 506

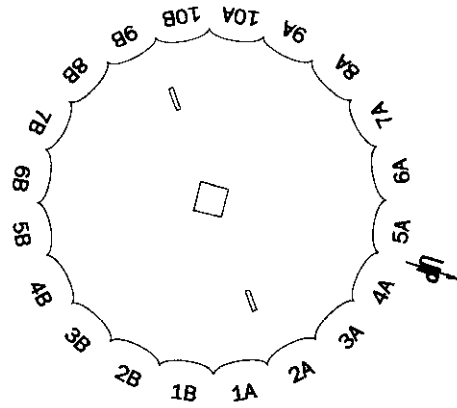

Block 809

Drums D – Bottom Surfaces

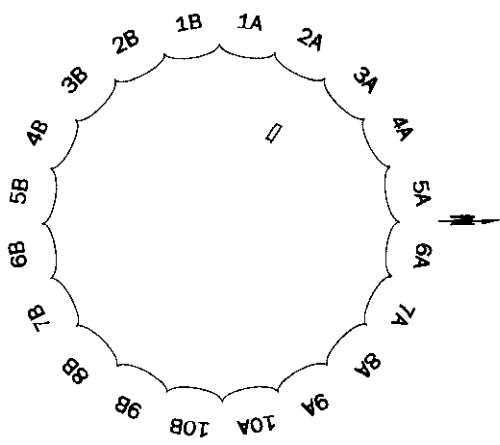

Block 5

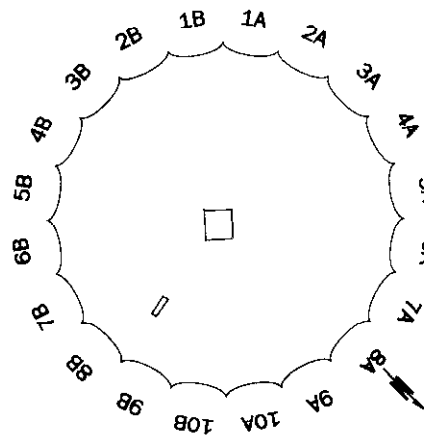

Block 7

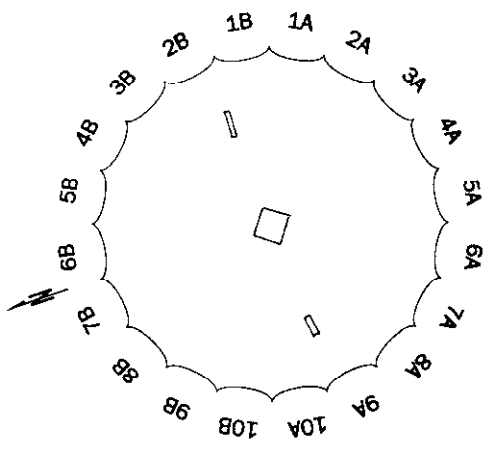

Block 33

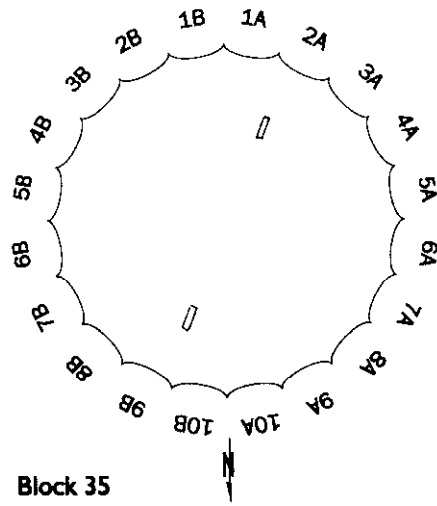

Block 35

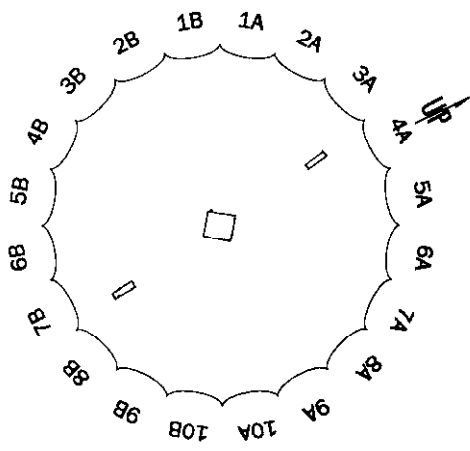

Block 80

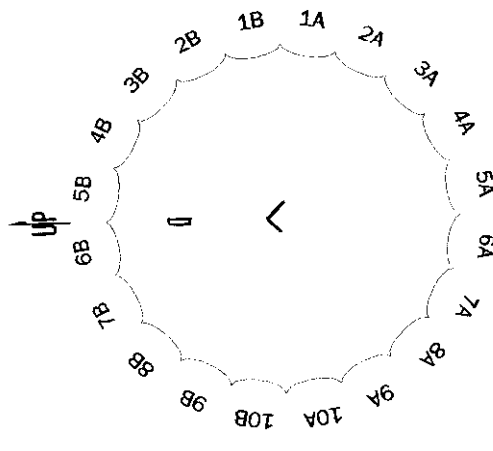

Block 492

Drums D – Top Surfaces

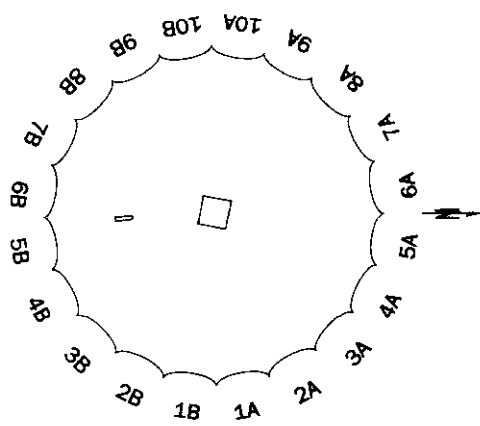

Block 5

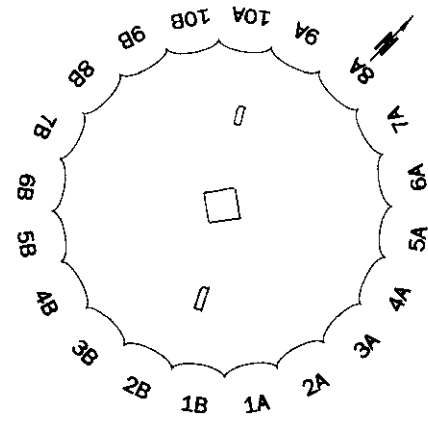

Block 7

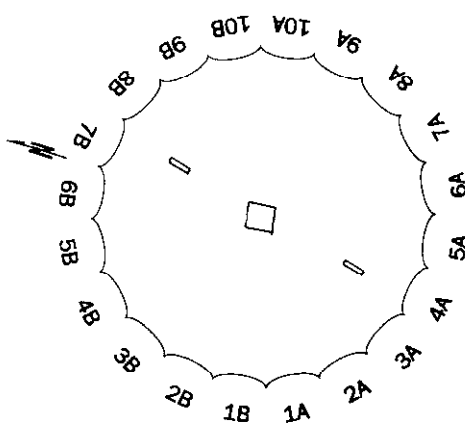

Block 33

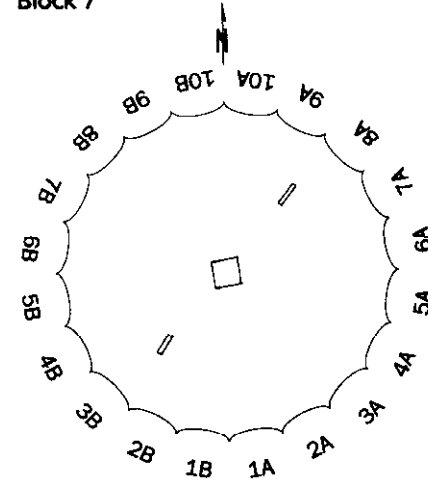

Block 35

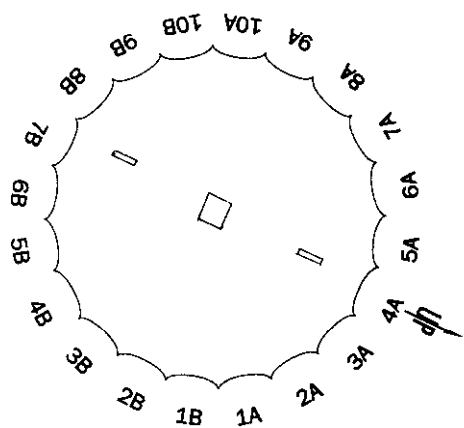

Block 80

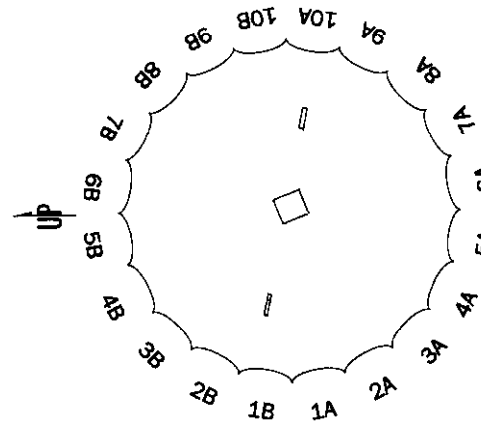

Block 492

Drums E – Bottom Surfaces

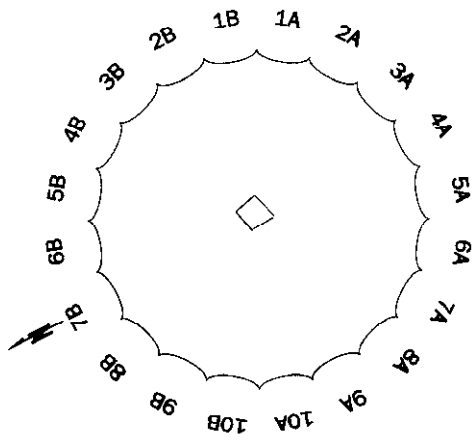
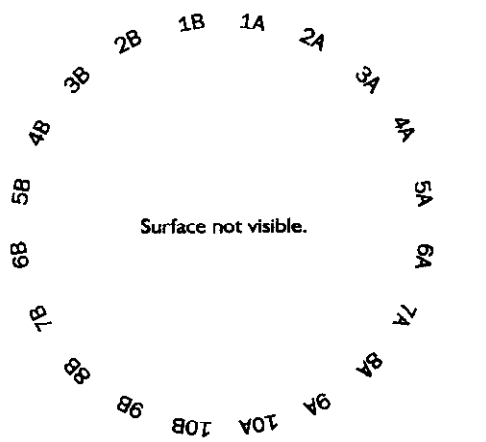

Blocks 16 & 17

Block 20

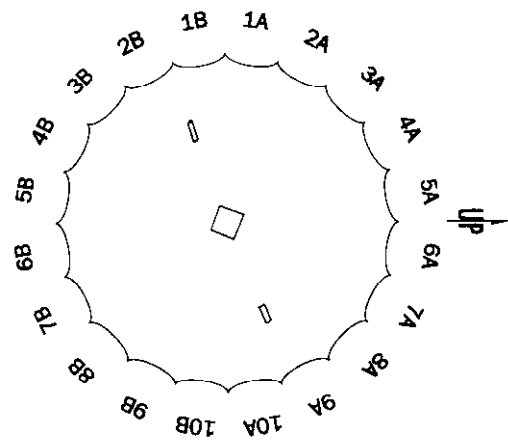
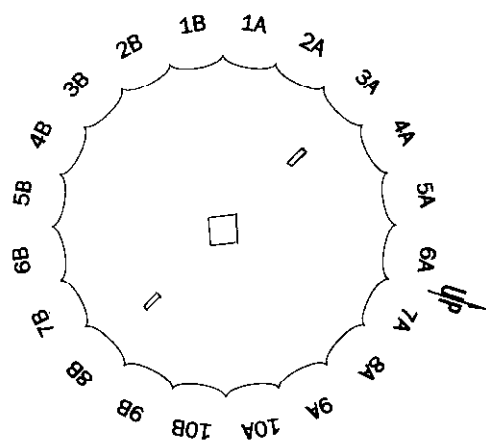

Block 88

Block 115

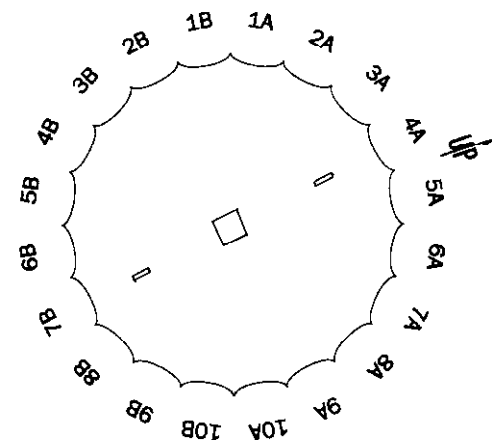
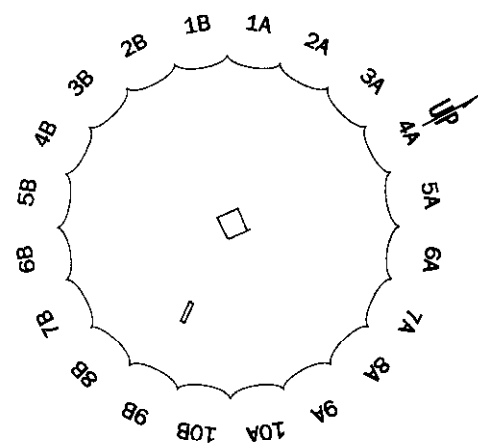

Block 401

Block 454

Drums E – Bottom Surfaces

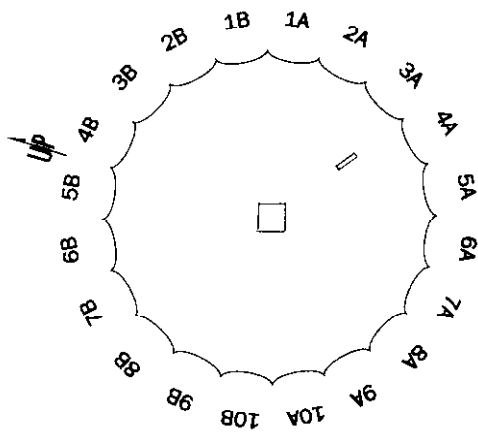

Block 497

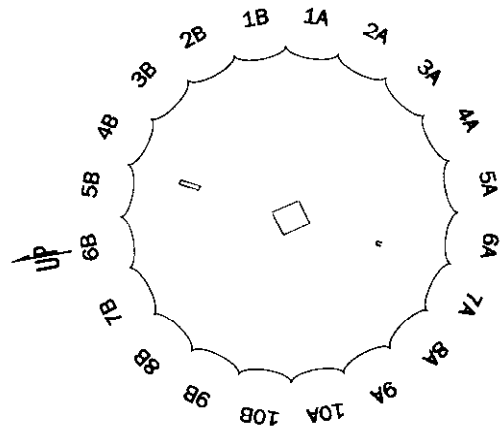

Block 533

Drums E -- Top Surfaces

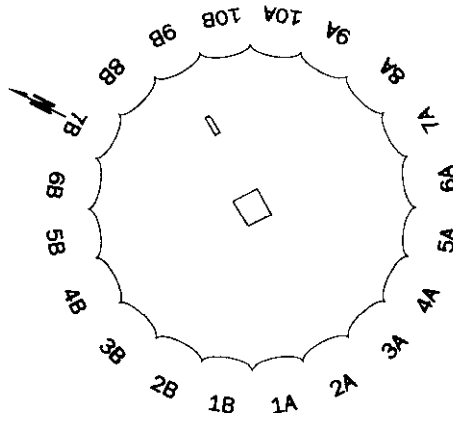
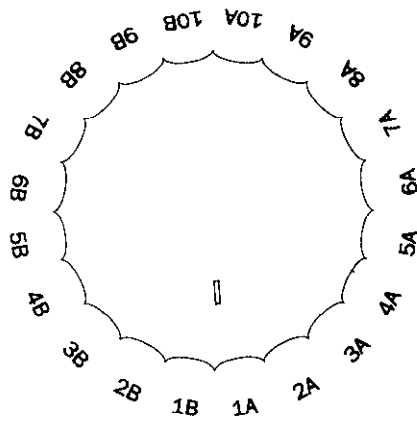

Blocks 16 & 17

Block 20

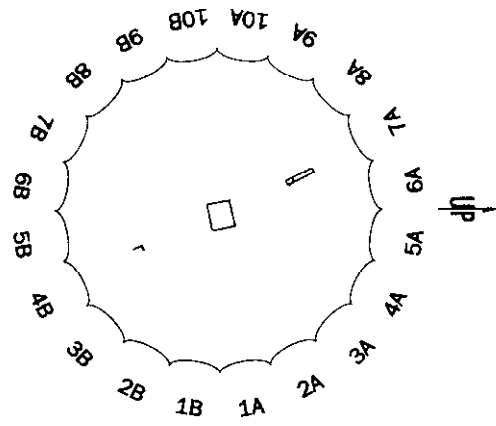
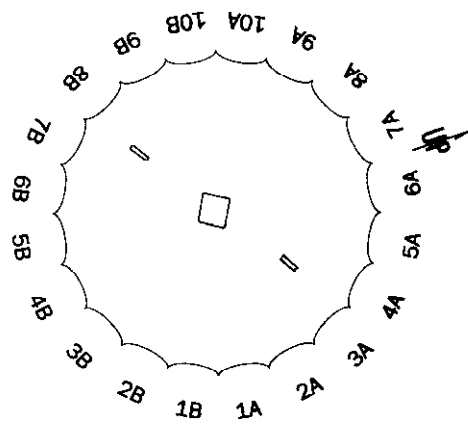

Block 88

Block 115

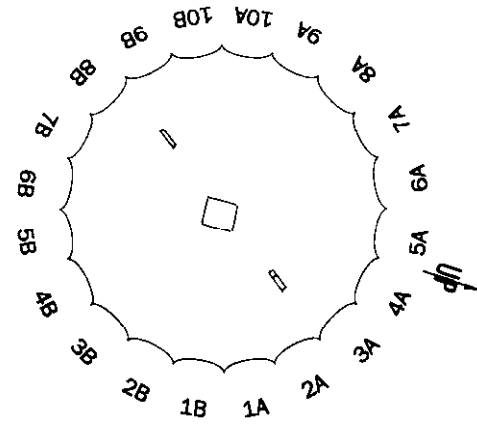
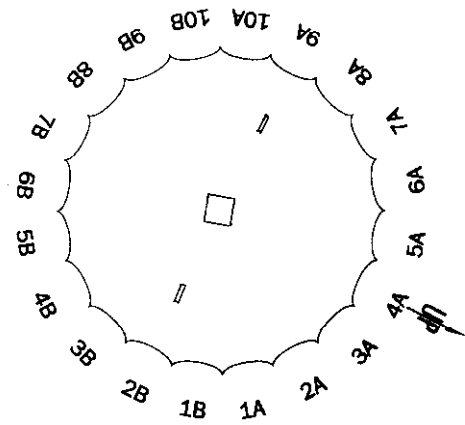

Block 401

Block 454

Drums E – Top Surfaces

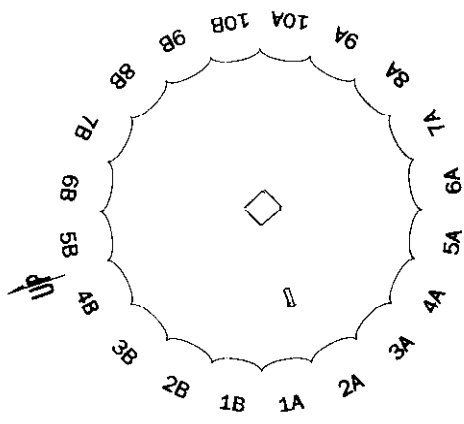

Block 497

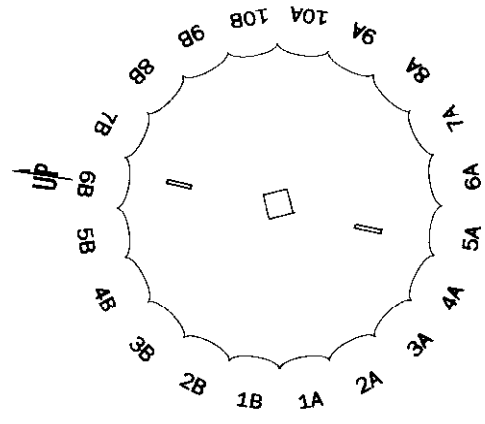

Block 533

Drums F – Bottom Surfaces

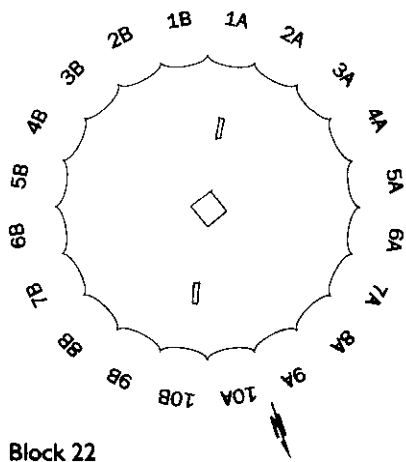

Block 22

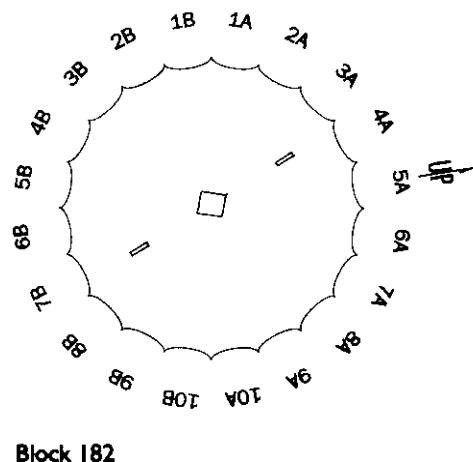

Block 182

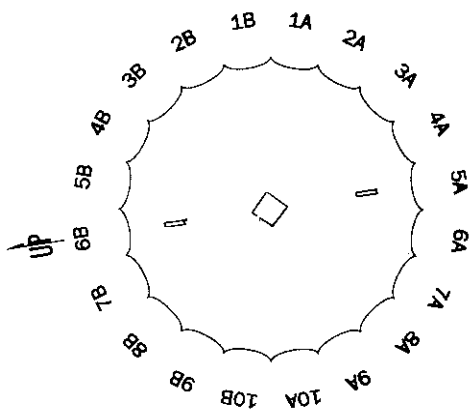

Block 544

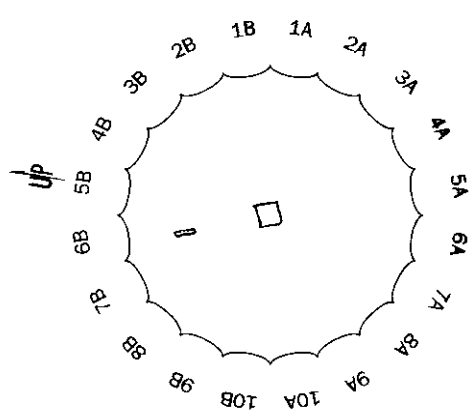

Block 542

Matching Drums

Pairs of drums that could on the basis of measurements match with each other are listed in the following. The schematic drawings of empolion cuttings and dowel holes of the drum pair have been checked: the information is typographically coded in the list.

Reverse	= Match according to 1:10 drawing
Bold, gray background	= Possible match according to 1:25 schematic drawings
Gray background	= Possible match according to 1:25 schematic drawings, but one or both surface drawings incomplete (e.g. only one dowel hole)
Bold	= Close, but not exact match
Normal	= No match
<i>Italics</i>	= No drawing of lower or upper face

A:8 B:24	A:51 B:563	B:36 C:9	B:498 C:15	C:27 D:90
<i>A:8 B:561</i>	A:93 B:6	B:36 C:15	<i>B:498 C:46</i>	C:27 D:41 ²
A:21 B:3	A:93 B:36	B:36 C:27	<i>B:498 C:94</i>	C:46 D:7
A:21 B:6	<i>A:93 B:79</i>	<i>B:36 C:46</i>	B:498 C:363	C:46 D:35
A:21 B:36	A:93 B:91	B:36 C:92	<i>B:498 C:809</i>	C:46 D:90
A:21 B:45	A:93 B:395	<i>B:36 C:94</i>	B:529 C:9	C:46 D:41 ²
<i>A:21 B:79</i>	A:93 B:498	B:36 C:135	B:529 C:15	C:46 D:492
A:21 B:91	A:564 B:3	B:36 C:363	B:529 C:27	C:92 D:5
A:21 B:395	A:564 B:6	B:36 C:506	<i>B:529 C:46</i>	C:92 D:7
A:21 B:498	A:564 B:24	B:45 C:9	B:529 C:92	C:92 D:33
A:21 B:529	A:564 B:36	B:45 C:15	<i>B:529 C:94</i>	C:92 D:35
<i>A:21 B:561</i>	A:564 B:45	B:45 C:27	B:529 C:135	C:92 D:90
A:21 B:563	A:564 B:395	<i>B:45 C:46</i>	B:529 C:363	C:92 D:41 ²
A:47 B:3	A:564 B:498	B:45 C:92	B:529 C:506	C:92 D:492
A:47 B:6	A:564 B:529	<i>B:45 C:94</i>	B:561 C:9	C:94 D:5
A:47 B:36	<i>A:564 B:561</i>	B:45 C:363	B:561 C:15	C:94 D:7
A:47 B:45	A:564 B:563	<i>B:45 C:809</i>	B:561 C:27	C:94 D:33
A:47 B:91		<i>B:79 C:9</i>	<i>B:561 C:46</i>	C:94 D:35
A:47 B:395	B:3 C:9	<i>B:79 C:15</i>	B:561 C:92	C:94 D:80
A:47 B:498	B:3 C:15	<i>B:79 C:27</i>	<i>B:561 C:94</i>	C:94 D:90
A:47 B:529	B:3 C:27	<i>B:79 C:92</i>	B:561 C:135	C:94 D:41 ²
<i>A:47 B:561</i>	<i>B:3 C:46</i>	<i>B:79 C:94</i>	B:561 C:363	C:135 D:7
A:47 B:563	B:3 C:92	<i>B:79 C:135</i>	B:561 C:506	C:135 D:33
A:48 B:3	<i>B:3 C:94</i>	<i>B:79 C:363</i>	B:563 C:9	C:135 D:35
A:48 B:6	B:3 C:135	<i>B:79 C:506</i>	B:563 C:15	C:135 D:90
A:48 B:24	B:3 C:363	B:91 C:9	B:563 C:27	C:135 D:41 ²
A:48 B:36	<i>B:3 C:809</i>	B:91 C:15	<i>B:563 C:46</i>	C:135 D:492
A:48 B:45	B:6 C:9	B:91 C:27	B:563 C:92	C:506 D:5
A:48 B:91	B:6 C:15	<i>B:91 C:46</i>	B:563 C:94	C:506 D:33
A:48 B:395	B:6 C:27	B:91 C:92	B:563 C:135	C:506 D:35
A:48 B:498	B:6 C:92	<i>B:91 C:94</i>	B:563 C:363	C:506 D:80
A:48 B:529	<i>B:6 C:94</i>	B:91 C:135	B:563 C:506	C:506 D:90
<i>A:48 B:561</i>	B:6 C:135	B:91 C:363		C:506 D:41 ²
A:48 B:563	B:6 C:363	B:91 C:506	C:9 D:7	C:809 D:5
A:51 B:3	B:6 C:506	B:395 C:9	C:9 D:35	C:809 D:80
A:51 B:6	B:24 C:9	B:395 C:15	<i>C:9 D:90</i>	<i>C:809 D:90</i>
A:51 B:36	B:24 C:15	B:395 C:27	<i>C:9 D:415</i>	
A:51 B:45	B:24 C:27	<i>B:395 C:46</i>	C:9 D:492	D:5 E:20
<i>A:51 B:79</i>	<i>B:24 C:46</i>	B:395 C:92	C:15 D:5	D:5 E:115
A:51 B:91	B:24 C:92	<i>B:395 C:94</i>	C:15 D:80	D:5 E:401
A:51 B:395	<i>B:24 C:94</i>	B:395 C:135	C:27 D:5	D:5 E:454
A:51 B:498	B:24 C:135	B:395 C:363	C:27 D:33	D:5 E:497
A:51 B:529	B:24 C:363	B:395 C:506	<i>C:27 D:35</i>	D:5 E:533
<i>A:51 B:561</i>	B:24 C:506	B:498 C:9	<i>C:27 D:80</i>	D:7 E:20

Appendix A: Column Drums A61

D:7	E:115	D:80	E:20	D:415	E:115	E:20	F:507	E:401	F:542
D:7	E:401	D:80	E:115	D:415	E:401	E:20	F:544	E:401	F:544
D:7	E:454	D:80	E:401	D:415	E:497	E:88	F:22	E:454	F:22
D:7	E:497	D:80	E:454	D:415	E:533	E:88	F:89	E:454	F:89
D:33	E:88	D:80	E:497	D:492	E:20	E:88	F:542	E:454	F:182
D:33	E:401	D:80	E:533	D:492	E:115	E:88	F:544	E:454	F:544
D:33	E:533	D:90	E:88	D:492	E:454	E:115	F:22	E:497	F:22
D:35	E:20	D:90	E:115	D:492	E:497	E:115	F:89	E:497	F:89
D:35	E:115	D:90	E:401			E:115	F:182	E:497	F:542
D:35	E:401	D:90	E:497	E:20	F:22	E:115	F:507	E:497	F:544
D:35	E:454	D:90	E:533	E:20	F:89	E:401	F:22	E:533	F:542
D:35	E:497	D:415	E:88	E:20	F:182	E:401	F:89		

Appendix B: Capitals

Measurements taken between preserved surfaces underlined.

For general abbreviations, see p. iii.

For abbreviations used for capitals, see also Fig. 12 (p. 33).

Trachelion height includes the height of the relieving edge.

All photographs by J.P.

C	Co-ordinates of the block
DiamEch _{max}	Maximum diameter of the echinus
DiamEch _L	Lower diameter of the echinus
DiamAnn _L	Lower diameter of the annulets
Diam _A	Diameter at the arrises
Diam	Diameter at the bottom of flutes

26. Capital. Abacus top and bottom surfaces largely preserved and partially 1 vertical abacus surface. No echinus profile. Greatest remaining abacus dimensions: c. 1.20 x c. 1.19 m. Lower surface with an empolion hole (0.13 x 0.13 m), upper with 4 dowel holes. Pres. c. 3/4.

H: 0.588.

C: On broken surface, 0.04 m S of the edge of the 45° surface. X: 39.82 Y: 0.93 Z: 0.57



Block 28.

28. Capital fragment. Something left of the surface attaching it to the column with remains of an empolion hole, 5 flutes. Full profile of the echinus, part of one side of the abacus. Pres. c. 2/5.

H: 0.589. AbH: 0.244. FIW: 0.189.

C: Empolion. X: 42.16 Y: 0.79 Z: -0.03

57. Capital fragment. Echinus and annulet profile preserved, abacus slightly on 1 side. Pres. c. 1/10.

H: 0.45.

C: On abacus at the SW side. X: 19.58 Y: 14.54 Z: -1.25



Block 86.

69. Capital fragment. Only abacus top accessible. Pry mark and dowel hole fit a capital. Surface ca. 1.30×0.75 . Pres. c. 2/5.

H: 0.609.

C: On W dowel hole. X: 27.18 Y: 19.07 Z: -1.24

86. Capital. About half preserved, but no empolion on the bottom surface. Trachelion with 7 flutes. Pres. c. 1/2.

EchH: 0.160. AnnH: 0.047. TrachH: 0.140. FIW: 0.189–0.190 (2 flutes).

C: Highest point. X: 30.35 Y: 21.04 Z: -1.08

109. Capital. No abacus vertical profile preserved. Full height probably preserved, bottom against the ground. Pres. c. 1/2. $1.40 \times 0.95 \times c. 0.55$ m.

C: On top of abacus, W side, 0.50 m from the N side. X: 55.91 Y: -1.46 Z: -1.15

133. Capital. Abacus fragmentarily, otherwise full profile preserved. 3 pry marks, 1 dowel hole on abacus top. Pres. c. 4/5.

H: 0.597. AbH: 0.243. EchH: 0.167. AnnH: 0.046. TrachH: 0.140. FIW: 0.187–0.188 (5 flutes).

AbW: ca. 1.624. DiamEch_{max}: 1.588. DiamEch_L: 1.288. DiamAnn_L: 1.234. Diam_A: 1.196.

Diam: 1.148.

C: Highest point. X: 46.53 Y: -7.37 Z: -0.60

143. Capital fragment. Small part of the echinus profile and annulets preserved. Pres. c. 5%.

H: 0.588.

C: Highest point. X: 41.35 Y: -7.58 Z: -1.00

276. Capital. No abacus vertical surface preserved. Total profile preserved, but not measurable due to conglomerate block next to the capital. Upside down. Pres. c. 9/10.

H: 0.593. Diam_A: 1.206. Diam: 1.151. FIW: 0.189–0.191 (20 flutes).

C: Empolion. X: 31.28 Y: -21.88 Z: -0.48



Block 133.



Block 276.

320. Capital fragment. Corner of abacus and part of echinus preserved. Pres. dimensions of the abacus 1.12×0.49 . Pres. c. $1/8$.

H: c. 0.48.

C: SE corner. X: 31.82 Y: -11.49 Z: -0.88



Block 514.



Block 516.

340. Pronaos capital. Dugas Pl. 57. Pres. c. 4/5. FIW: c. 0.165.
C: Empolion. X: 26.73 Y: -16.43 Z: -0.66

384. Capital. Only small part of the profile with annulets preserved. Bottom with empolion. Max.
Pres. dimensions c. 1.35 × 0.98. Pres. c. 3/5. H: 0.588.
C: Empolion. X: 7.19 Y: -14.76 Z: -0.72



Block 520.

501. Capital. All corners of abacus broken, otherwise complete. See Fig. 13 on p. 36 for drawing (Dugas *et al.* 1924, pl. 35; measurements slightly different, the ones adopted from this plate are in *italics* in the list below). Abacus top straight, no angle for horizontal curvature adjustment. Pres. c. 1/1.

H: 0.590. AbH: 0.247 (S face, 0.246 on E and N). EchH: 0.161. AnnH: 0.046. TrachH: 0.136. FIW: 0.190.

AbW: 1.610 (NS axis, 1.615 EW). DiamEch_{max}: 1.590. DiamEch_L: 1.302. DiamAnn_L: 1.246. Diam_A: 1.209. Diam: 1.158.

C: SW corner. X: -30.77 Y: -6.40 Z: -0.82

514. Capital. Abacus vertical faces completely broken, otherwise almost complete. Empolion cutting 0.105 x 0.11. Pres. c. 4/5.

EchH: 0.159. AnnH: 0.044. TrachH: 0.139. FIW: 0.188–0.191 (12 flutes).

DiamEch_{max}: 1.599. DiamEch_L: 1.307. DiamAnn_L: 1.253. Diam_A: 1.209. Diam: 1.155.

C: Empolion. X: -23.96 Y: -0.70 Z: -1.00

516. Capital. No abacus corners preserved. Pres. c. 1/2.

H: 0.592 (E side, 0.595 on S). AbH: 0.250 (E side, 0.246 on S). EchH: 0.159. AnnH: 0.047.

TrachH: 0.136. FIW: 0.190.

C: Empolion. X: -19.25 Y: -1.76 Z: -0.83

520. Capital. Broken on 3 sides, one with full profile. 2 pry marks and 1 dowel hole. Pres. c. 1/2.

H: 0.602. AbH: 0.251. EchH: 0.165. AnnH: 0.047. TrachH: 0.139. FIW: 0.190.

C: E of the W pry mark. X: -16.44 Y: -0.33 Z: -0.75



Block 539.



Block 562.

539. Capital. Almost complete. Abacus top with 3 pry marks and 2 dowel holes. Top surface straight, no angle for adjustment of horizontal curvature. Pres. c. 1/1.
H: 0.609. AbH: 0.243. EchH: 0.160. AnnH: 0.050. TrachH: 0.139. FIW: 0.189–0.191 (4 flutes).
AbW: 1.615 (NS axis, 1.609 EW). DiamEch_{max}: 1.599. DiamEch_L: 1.313. DiamAnn_L: 1.255.
Diam: 1.165. C: S of the S pry mark. X: -26.39 Y: 2.29 Z: -0.88

562. Capital. From the corner: band at the edge goes over corner, dowels not parallel but at a straight angle to each other. One corner of abacus largely broken, otherwise almost complete. See also Fig. 14 (Dugas *et al.* 1924, pl. 35; measurements adopted from this plate are in *italics* in the list below), profile in Fig. 12 on p. 33. Abacus top surface faces N. Pres. c. 9/10.
H: 0.590 (top, 0.589 W, 0.591 E). AbH: 0.248 (top, 0.246 W, 0.247 E). EchH: 0.158. AnnH: 0.046. TrachH: 0.138. FIW: 0.189–0.190 (2 flutes).
AbW: 1.616 (top to bottom, 1.609 EW). DiamEch_{max}: 1.604. DiamEch_L: 1.312. DiamAnn_L: 1.254.
Diam_A: 1.213. Diam: ca. 1.160.
C: SW corner of the top side of abacus. X: -14.34 Y: 13.60 Z: -0.29

Appendix C: Architrave and Frieze Blocks

Catalogue of Architrave and Frieze Blocks Diagnostic of Horizontal Curvature

Measurements taken between preserved surfaces underlined.

For general abbreviations see p. iii.

Drawings of blocks 503 and 531 by P. Pakkanen (1995), and of blocks 1, 159, 431, 489, and 534 by M. Clemmensen (1912). Angle measurements added on these by J. P.

C Co-ordinates of the block

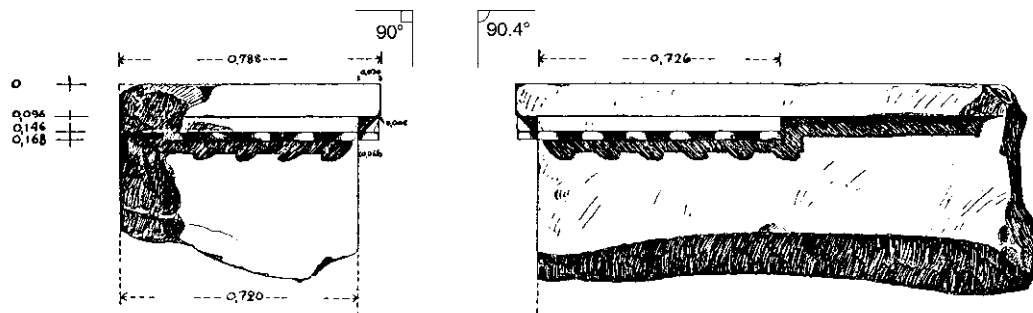

1. Architrave block, from corner. Dugas *et al.* 1924, pl. 38. Block adjusted for horizontal curvature: the angle between the N lateral surface below the taenia and regula and the top surface of the block is 90.4° (3 mm in 0.47 m). The other vertical face (W) is at a straight angle to the top of the block. Photographs of the angle measuring procedure on the next page.

W: 0.786. L: 1.568. Taenia H: 0.093 (at the corner), 0.096 (at 0.50 from corner).

C: Dowel hole, W-most. X: -12.84 Y: 12.07 Z: 0.13

84. Frieze block fragment. Upper part of a triglyph with a small trace of the metope. Metope taenia slightly preserved. Anathyrosis on the lateral surface. Dowel holes on the top. Angle between top and lateral surfaces 89.8° (2 mm in 0.47 m), adjusted for horizontal curvature.

H: c. 0.82. W: c. 0.86 (on triglyph). L: 0.82. Triglyph W: 0.71. Metope taenia H: 0.11.

C: On W side, 0.18 m from upper surface and 0.04 m from lateral side. X: 32.33 Y: 20.46 Z: -1.26

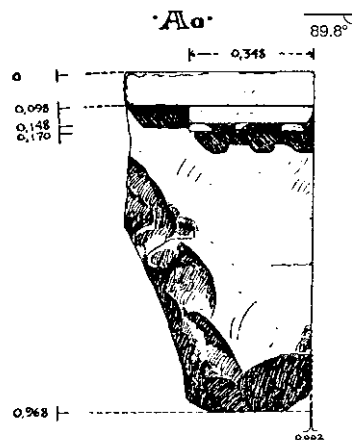

159. Architrave block. Dugas *et al.* 1924, pl. 39 A (preserved bottom surface only 0.145 m long, not 0.20 as in the drawing). Adjusted for horizontal curvature: angle between top and lateral surfaces 89.8° (3 mm in 0.715 m).

C: SW corner. X: 43.10 Y: -16.10 Z: -0.45



1. Architrave block, from corner. Measuring the angle. The line drawn on the metal square (right) enhanced. (Photographs by P. Pakkanen, 1995.)

329. Architrave block. Exterior upper edge broken, not possible to determine whether inner or exterior architrave. Lateral surface with anathyrosis preserved. Top with 1 dowel hole, 1 cutting for clamp and 1 pry mark. Angle between lateral and top surfaces is 90.8° (6.5 mm in 0.47 m). Angle between bottom and lateral surfaces cannot be directly measured, but from height measurements it can be calculated as 89.4° .

H (on the front of the block): 0.969. W: 0.700. L: 1.58.

C: N end. X: 30.46 Y: -13.73 Z: -0.19

362. Frieze block. Angle between top surface and lateral triglyph face 90° .

H: c. 0.72. W: c. 0.96 (on metope). L: 1.774.

C: Highest point, 0.08 m from N end. X: 16.89 Y: -15.74 Z: -0.09

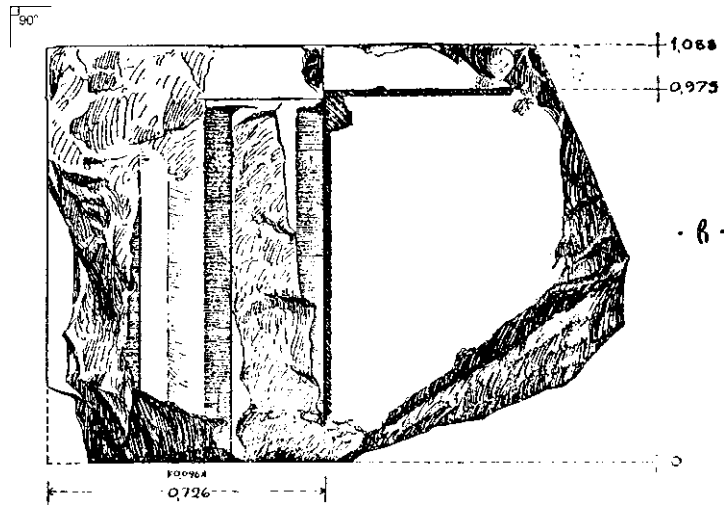

431. Frieze block from the corner. Dugas *et al.* 1924, pl. 43. Angle between the short side triglyph and top surface 90°.

C: NW corner. X: -9.68 Y: -14.24 Z: -0.26

482. Inner architrave block. Top surface with 1 dowel hole, 2 cuttings for clamps, and 1 pry mark. Back and lateral surfaces with anathyrosis. Angle between the lateral anathyrosis rim and top surface 90°. Most probably matching with exterior architrave 503 (clamp cuttings, angle at the corner).

H (at the back): 0.961. W: 0.705. L: 1.23.

C: W cutting for clamp. X: -25.27 Y: -12.66 Z: -0.67

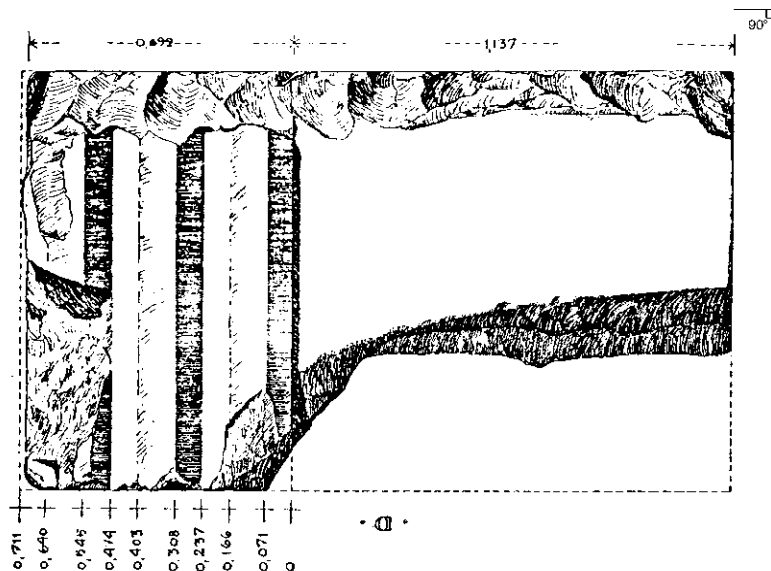

489. Frieze block. Dugas *et al.* 1924, pl. 41. The only measurable angle 90° (top corner of the metope). Top surface straight. No adjustment for horizontal curvature.

L (from metope edge to anathyrosis face): 1.815. L (from metope edge to side of the triglyph): 1.826.

C: S corner. X: -25.84 Y: -11.60 Z: -0.38

C4 *The Temple of Athena Alea at Tegea*

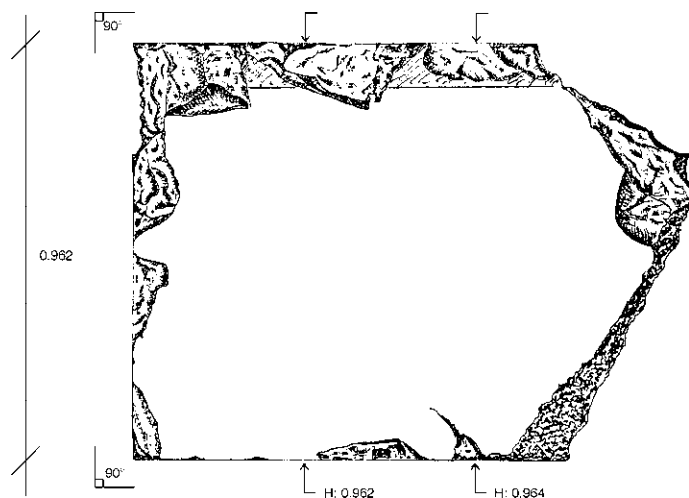

503. Architrave block. Taenia almost completely broken off. Top, front and bottom smooth, preserved lateral and back surfaces with anathyrosis. Angles between top and lateral surfaces and between lateral and bottom surfaces both 90° , but bottom surface is not straight (height of the block slightly varying). On the bottom a groove marking the edge of the abacus at 0.812-0.820 m from the end of the block (goes in 0.315 m from the face of the block, then disappears).
 H: 0.962 (at 0.40 from the lateral surface of the block), 0.964 (at 0.81). W: 0.719. L: 1.32.
 Taenia H: 0.090.
 C: E corner. X: -28.01 Y: -4.53 Z: -0.80

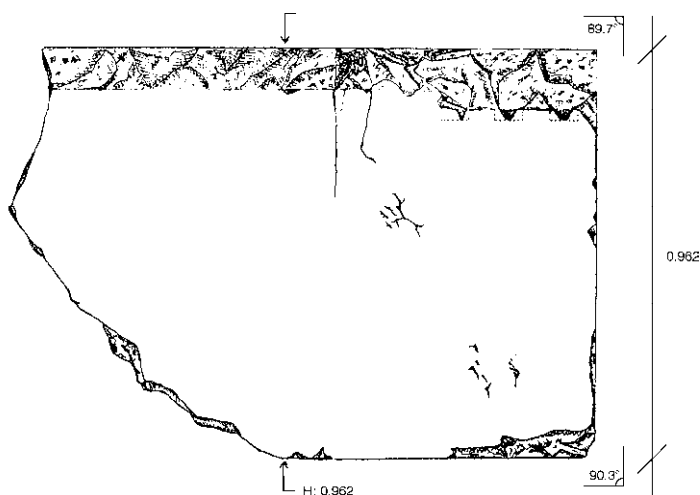

531. Architrave block. Traces of 3 guttae and taenia. Top, front and bottom surfaces smooth, lateral and back surfaces with anathyrosis rim. Angle between bottom surface and lateral side 90.2° (3 mm in 0.76 m). Top surface edge broken, so the angle cannot be directly measured, but on the basis of the height measurements it is 89.8° .
 H: 0.962 (right end of the block), 0.962 (at 0.72 in from the end). W: 0.720. L: 1.31.
 Taenia H: 0.093.
 C: SW corner. X: -19.97 Y: 3.20 Z: -0.73

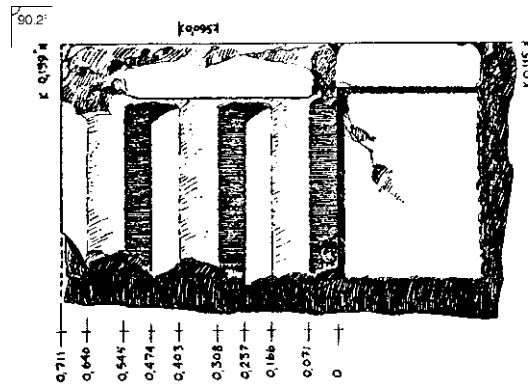

534. Frieze block. Dugas *et al.* 1924, pl. 42. Angle between the frieze lateral surface and the top of the block 90.2° (2 mm in 0.470 m). Adjusted for horizontal curvature.
C: SW corner. X: -25.55 Y: 0.63 Z: -0.90

794. Frieze block fragment. Metope taenia preserved. Angle between top surface and lateral metope surface 89.7° (4 mm in 0.82 m).
H: c. 0.71. W: c. 0.89. L: c. 1.11. Metope taenia H: 0.112.
C: NW corner. X: 12.32 Y: 23.19 Z: -0.93

Appendix D: Capital and Column Measurements Used in Architectural Comparison

General abbreviations used in the appendix are listed on p. iii.
All measurements in meters.

Table D1. Capital measurements.

	CapH	AbW	Diam _A	AbH	EchH
Bassai, t. of Apollo (type A)	0.534	1.229	0.927	0.204	0.172
Bassai, t. of Apollo (type B)	0.534	1.180	0.900	0.204	0.172
Bassai, t. of Apollo (type C)	0.501	1.172	0.900	0.190	0.153
Argive Heraion, second t. of Hera	0.560–565	1.369	c. 1.01	0.228–234	0.169
Delphi, tholos	0.353	0.893	0.671	0.142	0.097
Epidauros, t. of Asklepios	0.304	0.811	0.606	0.122	0.083
Delphi, 4th cent. t. Apollo	0.725	1.910	1.384	0.31	0.175
Delphi, 4th cent. t. Athena	0.362	0.967	0.725	0.143	0.095
Epidauros, tholos	0.38	1.02	0.75–0.77	0.159	0.105
Megalopolis, Thersilion	0.385	1.05	0.80	0.16	0.10
Nemea, t. of Zeus	0.624	1.76	1.307	0.250	0.166
Stratos, t. of Zeus	0.505	1.36	1.00	0.202	0.136
Olympia, Metroon	0.345	0.890	0.65	0.14	0.096

Table D2. Column measurements.

	ColH	ShaftH	Diam _{LA}	Diam _L	Diam _{UA}	Diam _U	FIW _L	FIW _U	Ent _{max}	EntH
A.	5.959	5.425–58	1.112	1.041	0.900	0.853	0.173	0.140	–	–
B.	7.10–43	6.60–92	c. 1.308	1.226	c. 1.011	0.965	0.205	0.158		
C.	5.93	5.58	0.868	0.812	0.671	0.642	0.136	0.105	0.005	3.0
D.	9.35	8.99	1.716		1.384	1.286	0.268	0.217		
E.	5.282	4.92	0.893	0.818	0.725	0.669	0.140	0.113	0.004	2.6
F.	6.9 / 7.5	6.5 / 7.1	0.998	0.944	0.772 / 0.750	0.740 / 0.718	0.156	0.121 / 0.117	0.01	3.4
G.	9.544–80	8.952–77	1.55	1.46	1.21	1.15	0.24	0.19	0.011	4.3–4.7
H.	3.86	3.64	0.556		0.458		0.087	0.72	0.008	2.0
I.	10.33	9.70	1.63	1.52	1.307	1.245	0.255	0.204	0.013	4.6
J.	7.9?	7.4?	1.31	1.22	1.00	0.96	0.205	0.156		

- A. Bassai, t. of Apollo (not frontal)
 B. Argive Heraion, Second t. of Hera
 C. Delphi, tholos
 D. Delphi, 4th cent. t. Apollo
 E. Delphi, 4th cent. t. Athena
 F. Epidauros, tholos (11/12 drums)
 G. Tegea, t. of Athena Alea
 H. Delphi, treas. of Kyrene
 I. Nemea, t. of Zeus
 J. Stratos, t. of Zeus

D2 *The Temple of Athena Alea at Tegea*

Table D3. Sources of measurements.

	Sources
Bassai, t. of Apollo	Cooper 1992, pls. 20 and 40. Cooper 1996, 184, 229–230.
Argive Heraion, 2nd t. of Hera Delphi, tholos	Pfaff 1992, 123–125, 130–131.; see also n. 51 on p. 73. Charbonneaux—Gottlob 1925, 4–5, pl. 4; Amandry—Bousquet 1940–41, 125 n. 2 (ColH, Diam _{LA}). FIWs calculated. For entasis, see Pakkanen 1997, 324–326.
Epidauros, t. of Asklepios	Roux 1961, 93 and 410–411. Only CapH given, rest calculated from tables on pp. 410–411 and checked by measuring from fig. 16.
Delphi, 4th cent. t. Apollo	Courby 1927, 17, figs. 11, 16, 17. AbH and EchH measured from fig. 17 and checked from Coulton 1979, tables 18 and 19. On ColH, Diam _{LA} , and entasis, see Ducoux 1940–41, 267.
Delphi, 4th cent. t. Athena	Michaud 1977, 31–36. FIWs calculated. For entasis, see Pakkanen 1997, 326.
Epidauros, tholos	Roux 1961, 138–140 and 410–411. AbW, AbH, and EchH calculated from tables on pp. 410–411 and checked by measuring from fig. 16. For ColH, ShaftH, Diam _{UA} , and entasis, see Pakkanen 1997, 327–329. FIWs calculated.
Tegea, t. of Athena Alea Delphi, treasury of Kyrene	New dimensions. Bousquet 1952, 46–48; For entasis, see Pakkanen 1997, 332–334.
Megalopolis, Thersilion	Gardner <i>et al.</i> 1892, fig. 18. AbW and AbH given, others measured from fig. 18; CapH and EchH checked from Coulton 1979, tables 16 and 19.
Nemea, t. of Zeus	Hill 1966, 9–10, pls. 13 and 27. EchH measured from pl. 27. For entasis of the pronaos column, see Pakkanen 1997, 334–336.
Stratos, t. of Zeus Olympia, Metroon	Courby—Picard 1924, 25–29. FIWs calculated. Adler <i>et al.</i> 1892, 37, pl. 26. CapH measured from pl. 26 and checked from Coulton 1979, table 16.

Appendix E: Computer Programs

The programs used in the analyses have been written especially for the purposes of shaft analysis, and they have been implemented on top of MS-DOS program Survo 84C.¹ Survo is an open system which provides very good tools for graphics, report generating, statistical analysis, and database management, and it also supports extensions made by the user. Both sucros (Survo or super macros) and additional modules written in C language have been used.² The output of the programs is stored in Survo data files.³ In the following, a short description of the programs is given, and full program listings can be found on pp. E4–30.

1. Computer-intensive Statistics

A. Bootstrap- t method

The sucro program `bootstrap-t_fp.tut` is used in Section V.2.B. (pp. 53–54) to calculate the 95% bootstrap- t confidence interval on the basis of the preserved column drums at Tegea. The sucro code is listed on pp. E4–E5, and an example how the program is used in connection with the drums at Tegea is given on lines 106–125 of p. E5. The parameters of the program (line 115) must include the name of the data list in the edit field (X , on lines 107–113), the name of the data file for output (BT001.SVO), the number of t -values produced (5000), and the size of the population, or, in this case, the number of column drums originally in the building (216). The results are printed on lines 117–125.

B. Monte Carlo Test for Evaluating Bootstrap Method

The sucro program `strapeva.tut` is used in Section V.2.C. (pp. 54–55) to test the validity of bootstrap- t method. The sucro code is listed on pages E6–7, and an example how the program is used to simulate the temple colonnade at Tegea and to test the accuracy of bootstrap confidence intervals is given on lines 88–123 of p. E7. The program uses C module `!simul.exe` (lines 38–41; see also pp. E2 and E10–22), and the parameters listed on lines 91–112 are needed by the module, even though `strapeva.tut` uses only the drum height data listed on lines 114–121 (Position 0 corresponds to A drums, 1 to B drums, etc.) in the simulation. The parameters of the program line (line 123) must include the name of the data in the edit field (DRUMS, on lines 114–121), the number of repetitions for each height (8), the starting height of the simulation (8.76 m), the distance between the heights (0.02 m), the maximum shaft height (8.98 m), and the name of the data file for output (STRAPEVA.SVO). The results stored in the output file (see lines 23–30) are the lower limit of the confidence interval ($Clmin$, in meters), the upper limit of the confidence interval ($Clmax$), shaft height used in the simulation ($ColH$), the value of the lower bootstrap t -value ($t1$), the value of the higher bootstrap t -value ($t2$), and the mean and standard deviation of the simulated sample ($mean$ and std).

¹ I have compiled the two C modules listed in App. E for Survo 84C, and they are not currently compatible with the new 32-bit version of the program, Survo 98.

² On sucros see Mustonen 1992, 399–443, and on programming Survo in C see Mustonen 1989.

³ On data files, see Mustonen 1992, 75–130.

C. Non-random Data

The `sucro` program `simuhght.tut` is used in Section V.2.D. (pp. 55–56) to simulate the effect of non-randomness of the column drum data on the shaft height distribution. The `sucro` code is listed on pp. E8–9, and an example is given on lines 93–128 of p. E9. The parameters listed on lines 96–117 are used by the C module `!simul.exe`. The degree of randomness of the data is simulated by changing the amount of columns used by the module. The number of columns is given on lines 102–103: six columns on the front and eight on the sides corresponds to a total of 24 columns ($2 \times 6 + 2 \times 6 = 24$). The drum height data is listed on lines 119–126. The parameters of the program line (line 128) must include the name of the data in the edit field (DRUMS, on lines 114–121), the number of repetitions for each height (24), the starting height of the simulation (8.76 m), the distance between the heights (0.02 m), the maximum shaft height (8.98 m), and the name of the data file for output (SIMUHT24.SVO). The results stored in the output file (see lines 24–32) are the number of the simulation (*Nro*), the mean of the simulated sample (*Height*), the lower limit of the confidence interval (*CIMin*, in meters), the upper limit of the confidence interval (*CIMax*), shaft height used in the simulation (*OrHght*), difference between the simulated shaft height and the original ($HDiff = Height - OrHght$), the confidence interval width (*CIW*), and whether the original shaft height is within the simulated confidence interval or not (*OK*).

2. Shaft Profile

A. Colonnade Simulation

The C module `!simul.exe` can be used to simulate construction of a colonnade, the process of its destruction and its reconstruction by a scholar (see pp. 54–55). The example on pp. E23–24 presents how the program can be used to build a file of the possible shaft combinations based on the preserved drums at Tegea (see Section V.3.A, p. 62). It is also used by the two programs described above in Sections 1.B and 1.C. The program code is printed on pp. E10–22.

Then most important programmer defined functions are listed on lines 696–917: they map the possible shaft combinations. The function `first_path_all()` takes the first bottom drum and looks for a matching second level drum: the diameter ranges of the two drums have to be overlapping. When this is found, the drum data is recorded, and a search for a next level drum is started. This pattern is repeated until a matching top level drum is found. If a dead-end is reached before the top drums, the program goes back to the next lower level drum and starts the search again. All the complete possible column combinations are recorded into a text file: the program keeps track of the individual drum heights and margins, and besides the total height also the height margins are recorded. After this the program returns to other top level drums and tries to look for a new match, and when all top drums have been mapped and the data of the new combinations written into the text file, the program goes back to the level below etc. until all the possible shaft combinations with this particular bottom drum have been found. Then the procedure is repeated for the next bottom drum until all the conceivable ways to combine the drums have been discovered.

In the example the parameters input to the program are listed and explained on lines 2–23 on p. E23. The Tegea drum data is listed on lines 27–75, and the data file `TEGEADR.SVO` is created from the text file produced by the program on lines 77–137. The data file includes the *x* and *y* co-ordinates of the shaft profile as well as the measurement margins.

B. Acceptable Shaft Profiles and Maximum Entasis

The `sucro` program `shaft-maxent.tut` is used in Section V.3.B. (pp. 62–66) to determine the number of acceptable shaft combinations within measurement accuracy. The code of

the sucro and programs called by it are listed on pp. E25–30. The example given on lines 361–364 (p. E30) is used to produce the data in Table 9 on p. 65. The parameters of the program line (line 364) must include the name of the data file with co-ordinate data (TEGEADR2.SVO—the data file includes the shafts within the height range 8.952–8.977 from data file tegeadr.svo; on the latter file, see p. E2), the identification number the first used record (1), the identification number the last record (1,678), the minimum amount of maximum entasis (0.009 m), the maximum amount of maximum entasis (0.013 m), the minimum proportional height of the entasis (0.40), the maximum proportional height of the entasis (0.60), and the measurement accuracy (0.0015 m). The results stored are in data file SHAFTFIT.SVO (see lines 28–32 on p. E25): it includes the height of maximum entasis ($EntH$), the amount of maximum entasis ($MaxEnt$), and the number of shaft combinations in each category (N). It is the responsibility of the user to save the data file under a new name before reactivating the sucro shaft-maxent.tut. The other programs used in the analysis, shaft-curve.tut and !lsqmat.exe, are listed on lines 61–358 (the programs are nested so that shaft-maxent.tut calls the sucro shaft-curve.tut which in turn accesses the module !lsqmat.exe).

1.A. Bootstrap-*t* method

```

31 1 SURVO 84C EDITOR Sat Dec 12 22:33:07 1998          D:\COLMON\ 140 100 C
1  *BOOTSTRP-T_FP.TUT
2  *
3  *tutsave bootstrp-t_fp
4  / Sucro bootstrp-t_fp.tut by Jari Pakkanen (Nov 16 1998)
5  / for calculating confidence interval of a finite population
6  / using bootstrap-t method.
7  / def Wdata=W1 Wfile=W2 Wrep=W3 WN=W4 Wl=W5 Wlin=W6 Wcol=W7 Wamsan=W8
8  / def Wstd=W9 Wn=W10 Wt025=W11 Wt975=W12 Wlim1=W13 Wlim2=W14
9  *{tempo -1}{init}{save cursor Wlin,Wcol}
10 - if Wdata '<>' ? then goto A
11 *(line start){d}{erase}{erase}DATA X: 1.465 1.469 1.472 1.473 1.474 1.
12 *466 1.470 1.474 1.472 1.464(R)
13 *(erase){erase}1.472 1.465 1.469 1.472 1.473 1.474 1.466 1.470 1.474 1
14 *.472 1.464 END(R)
15 *(R)
16 *(erase){erase}Activating sucro(R)
17 *(erase){erase}/BOOTSTRP-T_FP <data>,<file>,<repetitions>,<pop. size>(R)
18 *(erase){erase}calculates bootstrap-t values from edit field data <dat
19 *a> given in the(R)
20 *(erase){erase}same format as data set X above. T-values are stored in
21 * file <file>.(R)
22 *(erase){erase}{goto End}
23 /
24 + A: {Wi=0}{R}
25 *#SCRATCH /{act}{home}STAT {print Wdata},CUR+1{act}{ins}{search}N=(R)
26 *(r2) {save word Wn}{search}mean=(R)
27 *(r5) {save word Wsmean}{search}stddev=(R)
28 *(r7) {save word Wstd}{ins}{jump Wlin,Wlin,1,1}(R)
29 *#SCRATCH /{act}{home}FILE CREATE HELPFLO4(R)
30 *FIELDS:(R)
31 * 1 NA_ 8 T          (#####.####)(R)
32 *END(R)
33 *(u4){act}
34 / Starting loop:
35 + Loop: {Wi=Wi+1}{jump Wlin,Wlin,1,1}(R)
36 *#SCRATCH /{act}{home}FILE CREATE HELPFLO1(R)
37 *FIELDS:(R)
38 * 1 NA_ 4 N          (####)(R)
39 * 2 NA_ 8 {print Wdata}          (####.###)(R)
40 *END(R)
41 *(u5){act}{line end}{l}2{act}{home}@SCRATCH /{act}{home}FILE COPY {}
42 *(print Wdata),HELPFLO1{act}(R)
43 *VAR N=ORDER TO HELPFLO1{act}(R)
44 *FILE INIT HELPFLO2,{print Wn}{act}(R)
45 *INSEED=SEED OUTSEED=SEED(R)
46 *VAR N=int({print Wn}*rand(1))+1 TO HELPFLO2{act}(R)
47 *. {copy}(R)
48 *(R)
49 *FILE SORT HELPFLO2 BY N TO HELPFLO3{act}(R)
50 *. {copy}(R)
51 *(R)
52 *VARS={print Wdata} MATCH=N MODE=2(R)
53 *FILE COPY HELPFLO1,HELPFLO3{act}(R)
54 *. {copy}(R)
55 *(R)
56 *VAR {print Wdata}=if({print Wdata}=MISSING)then({print Wdata}[-1])els
57 *e({print Wdata}) TO HELPFLO3{act}(R)
58 *. {copy}(R)
59 *(R)
60 *STAT HELPFLO3,CUR+10 / VARS={print Wdata}{act}(R)
61 *. {copy}(R)
62 *(R)
63 *(R)
64 *DATA TDATAxxx(R)
65 *T(R)
66 *(R)
67 *(R)

```

```

31 1 SURVO 84C EDITOR Sat Dec 12 22:39:39 1998          D:\COLMON\ 140 100 G
68 *FILE COPY TDATA\XXX,HELPPFL04(R)
69 *(R)
70 *T=(mean-(print Wsmean))/(stddev/sqrt((print Wn)))(R)
71 *{u5}T={act}{home}{del2}{R}
72 *(R)
73 *(act)
74 - if W1 < Wrep then goto Loop
75 *(jump Wlin,Wlin,1,1)(R)
76 *SCRATCH /{act}{home}FILE SORT HELPPFL04 BY T TO (print Wfile){act}(R)
77 *VAR Nro=ORDER TO (print Wfile){act}(R)
78 *int((print Wrep)*0.025)={act}[save line Wt975](R)
79 - if Wt975 > 0 then goto Cont
80 *(Wt975=1)
81 + Cont: int((print Wrep)*0.975)+1={act}[save line Wt025](R)
82 *IND=Nro, (print Wt975) VARS=T(R)
83 *FILE LOAD (print Wfile){act}(R)
84 *(d2){next word}{save word Wlim1}(R)
85 *. (copy)(R)
86 *(R)
87 *IND=Nro, (print Wt025) VARS=T(R)
88 *FILE LOAD (print Wfile){act}(R)
89 *(d2){next word}{save word Wlim2}(R)
90 *(jump Wlin,Wlin,1,1)(R)
91 *SCRATCH /{act}(R)
92 *Bootstrap t-values: t1=(print Wlim1) (obs. (print Wt975) in {})
93 *(print Wfile).svo)(R)
94 * t2=(print Wlim2) (obs. (print Wt025) in {})
95 *(print Wfile).svo)(R)
96 *Sample statistics: n=(print Wn) N=(print WN) mean=(print Wsmean)
97 *(R)
98 * stddev=(print Wsstd)(R)
99 *Estimated standard error: E=stddev/sqrt(n)*sqrt(1-n/N)(R)
100 *Lower limit of the Confidence interval:(R)
101 * mean-t2*E={act}(R)
102 *Upper limit of the Confidence interval:(R)
103 * mean-t1*E={act}(R)
104 + End: (jump Wlin,Wlin,1,1){tempo +1}{end}
105 *
106 *EXAMPLE:
107 *DATA X:
108 *1.465 1.469 1.472 1.473 1.474 1.466 1.470 1.474 1.472 1.464 1.472 1.481
109 *1.476 1.478 1.482 1.469 1.474 1.484 1.473 1.477 1.478 1.321 1.399 1.413
110 *1.444 1.457 1.479 1.498 1.500 1.510 1.561 1.643 1.668 1.415 1.447 1.448
111 *1.480 1.493 1.511 1.514 1.658 1.708 1.347 1.356 1.368 1.382 1.398 1.411
112 *1.438 1.515 1.522 1.580 1.662 1.320 1.331 1.349 1.479 1.484 1.500 1.631
113 *END
114 *
115 */BOOTSTRP-T_PP X,BT001.5000,216_
116 *
117 *Bootstrap t-values: t1=-2.1863 (obs. 125 in BT001.svo)
118 * t2=1.8455 (obs. 4876 in BT001.svo)
119 *Sample statistics: n=60 N=216 mean=1.476383
120 * stddev=0.082748
121 *Estimated standard error: E=stddev/sqrt(n)*sqrt(1-n/N)
122 *Lower limit of the Confidence interval:
123 * mean-t2*E=1.4596285045566
124 *Upper limit of the Confidence interval:
125 * mean-t1*E=1.4962314710852

```

1.B. Monte Carlo Test for Evaluating Bootstrap Method

```

48 1 SURVO 84C EDITOR Sat Dec 12 23:05:49 1998 D:\COLMON\ 140 100 G
1 *STRAPEVA.TUT
2 *
3 *TUTLOAD STRAPEVA
4 / Sucro strapeva.tut by Jari Pakkanen (Nov 18 1998)
5 / for evaluating the accuracy of bootstrap confidence intervals of
6 / column shafts.
7 *[tempo -1][init]
8 - if W1 '<' ? then goto A
9 *(line start){d}{erase}{erase}Activating sucro{R}
10 *{erase}{erase}/STRAPEVA <data>,<reps>,<minh>,<step>,<maxh>,<file>{R}
11 *{erase}{erase}simulates temple colonnades and tests the accuracy of b
12 *ootstrap CIs.{R}
13 *{erase}{erase}and stores the results in data file <file>.svo.{R}
14 *{erase}{erase}Specifications must be given as in the example edit fie
15 *ld.{goto End}
16 / def Wdata=W1 Wrep=W2 Wmin=W3 Wstep=W4 Wmax=W5 Wfile=W6
17 / def Whelp1=W7 Wlin2=W8 Wcol2=W9 Wi=W10 Wj=W11 Wk=W12
18 / def Wflin=W13 Wlline=W14 Wpresdr=W15 WCImIn=W16 WCImax=W17
19 / def Wmeanh=W18 Wlin=W19 Wcol=W20 Wcolld=W21 Wcolldu=W22 Wcolh=W23
20 / def Wlow=W24 Whigh=W25
21 + A: (save cursor Wlin,Wcol){Wj=Wmin}{R}
22 *SCRATCH /{act}{home}FILE CREATE {print Wfile}{R}
23 *FIELDS:{R}
24 * 1 NA 4 CImIn (##.###){R}
25 * 2 NA 4 CImax (##.###){R}
26 * 3 NA 4 ColH (##.###){R}
27 * 4 NA 4 t1 (##.###){R}
28 * 5 NA 4 t2 (##.###){R}
29 * 6 NA 4 mean (##.###){R}
30 * 7 NA 4 std (##.###){R}
31 *END{R}
32 *(u10){act}@SCRATCH /{act}
33 + MainLoop: {jump 1,1,1,1}{search}ColH={R}
34 *{find =}{r}{print Wj} {Wi=0}
35 /
36 / Starting loop:
37 + Loop: {Wi=Wi+1}
38 / Calling SIMUL.EXE:
39 *{jump 1,1,1,1}{search}Mode={R}
40 *{find =}{r}2{jump Wlin,Wlin,1,1}{d}@SCRATCH /{act}{home}SIMUL {}
41 *{write Wdata},CUR+3,0,70,-100{act}{jump Wlin,Wlin,1,1}{d4}{erase}Col {}
42 *Dr DiamL MaN1 MaP1 DiamU MaN2 MaP2 Height MaN3 MaP3{R}
43 *{save cursor Wlin2,Wcol2}{Wflin=Wlin2}{u}{pre}{d}{pre}{d}{u}
44 *{save cursor Wlin2,Wcol2}{Wlline=Wlin2}{jump 1,1,1,1}{search}PresDr=
45 *{R}
46 *{find =}{r}{ins} {ins}{save word Wpresdr}{l}{del}
47 /
48 / Selecting the preserved drums:
49 *{Wk=0}
50 + Preserved: {jump Wlin,Wlin,1,1}{d2}{erase}int({print Wflin})+
51 *{print Wlline}+1-({print Wflin})*rnd(0)={act}{save line Wlin2}
52 *{jump Wlin2,Wlin2,1,1}{save char Whelp1}
53 - if Whelp1 '=' * then goto Preserved
54 **{Wk=Wk+1}
55 - if Wk < Wpresdr then goto Preserved
56 *{jump Wlin,Wlin,1,1}{d5}
57 + Del: {save char Whelp1}{next word}{save cursor Wlin2,Wcol2}
58 *(line start)
59 - if Wcol2 = 1 then goto Cont
60 - if Whelp1 '=' * then goto Del2
61 *(del line){goto Del}
62 + Del2: {d}{goto Del}
63 + Cont: {jump Wlin,Wlin,1,1}{d2}{erase}{d}DATA X:{R}
64 *{erase}DELETE 50{home}{act}{r7}{act}{del line}{home}{u}{pre}{d}{pre}
65 *{d}END{R}
66 *. {copy}{R}
67 *{R}

```

```

48 1 SURVO 84C EDITOR Sat Dec 12 23:06:30 1998          D:\COLMON\ 140 100 G
68 *DATA DR{R}
69 *Cimin Cimax ColH t1 t2 mean std{R}
70 *(R)
71 *(R)
72 *(save stack helpstck)/BTSTRP P X,BTSTRE01,1000,216{tempo +1}{act}
73 *(tempo -1){load stack helpstck}{d8}{find =}{r}{save line WCimin}{R}
74 *(d){find =}{r}{save line WCimax}{R}
75 *(u13){print WCimin} {print WCimax} {print Wj} t1={act}{13}{del3}
76 *(line end) t2={act}{13}{del3}{line end} mean={act}{15}{del5}
77 *(line end) stddev={act}{17}{del7}{R}
78 *SCRATCH /{act}{R}
79 *SAVEP C:\E\RESULTS{act}{home}{erase}{d}FILE COPY DR,{print Wfile}.SVO
80 *(act)
81 /
82 - if Wi < Wrep then goto Loop
83 *(Wj=Wj+Wstep)
84 - if Wj <= Wmax then goto MainLoop
85 + End: {jump Wlin,Wlin,1,1}{tempo +1}{end}
86 *
87 *
88 *EXAMPLE:
89 *All dimensions in meters (Parameters needed for SIMUL.EXE; only
90 *      height data used by STRAPEVA.TUT.)
91 *ColDiamL=1.455      Lower diameter of the column between flutes
92 *DiamVar=0.005      Range of lower diameters (plus and minus)
93 *ColDiamU=1.15      Upper diameter of the column between flutes
94 *ColH=8.92          Column height
95 *MaxEnt=0.01        Maximum entasis
96 *MaxEntH=4.50       Height where the maximum entasis is
97 *ColNFr=6           Number of columns on front
98 *ColNS=14           Number of columns on side
99 *DrN=6              Number of drums in one column
100 *PresDr=60          Number of preserved drums
101 *MinMarg=0.003      Minimum margin for measurements
102 *MaxMarg=0.003      Maximum margin for measurements
103 *Search=ALL         Place of possibly matching drums (ALL or number of
104 *                    adjacent columns where to look for)
105 *Mode=2             0 = Create, select, print and match
106 *                    1 = Create, select and print
107 *                    2 = Create and print
108 *                    3 = Read drum data from the edit field and match
109 *Zcoord=0           0 = No Printing of the drum Z coordinate
110 *                    1 = Print the drum Z coordinate
111 *Profile=0          0 = No printing of shaft profile coordinates
112 *                    1 = Print the shaft profile coordinates
113 *
114 *DATA DRUMS
115 * Pos      MinH      MaxH
116 * 0         1.46      1.48
117 * 1         1.46      1.49
118 * 2         1.30      1.73
119 * 3         1.30      1.73
120 * 4         1.30      1.73
121 * 5         1.30      1.73
122 *
123 */STRAPEVA DRUMS,8,8,76,0.02,8.98,STRAPEVA

```

1.C. Simulating Non-random Data

```

37 1 SURVO 84C EDITOR Sat Dec 12 23:22:26 1998      D:\COLMON\ 140 100 C
1  *SIMUHGT.TUT
2  *
3  *TUTLOAD SIMUHGT
4  / Sucro simuhgt.tut by Jari Pakkanen (Nov 25 1998)
5  / for calculating simulated classical confidence
6  / intervals of shaft height.
7  *[tempo -1]{init}
8  - if W1 '<' ? then goto A
9  *(line start){d}{erase}{erase}Activating sucro{R}
10 *(erase){erase}/SIMUHGT <data>,<reps>,<minh>,<step>,<maxh>,<file>{R}
11 *(erase){erase}simulates temple colonnades and defines a classicalconf
12 *idence {R}
13 *(erase){erase}interval for the mean shaft height. The results are sto
14 *red in data file{R}
15 *(erase){erase}<file>.svo. Specifications must be given as in the exam
16 *ple edit field.{goto End}
17 / def Wdata=W1 Wrep=W2 Wmin=W3 Wstep=W4 Wmax=W5 Wfile=W6
18 / def Whelp1=W7 Wlin2=W8 Wcol2=W9 Wl=W10 Wj=W11 Wk=W12
19 / def Wflin=W13 Wlline=W14 Wpresdr=W15 Wlin=W17 Wcol=W18
20 / def Wt025=W19 Wt975=W20 Wlim1=W21 Wlim2=W22
21 / def WClmin=W23 WClmax=W24 Wmeanh=W25 Wcolh=W26
22 + A: {save cursor Wlin,Wcol}{Wj=Wmin}{R}
23 *MSCRATCH /{act}{home}FILE CREATE {print Wfile}{R}
24 *FIELDS:{R}
25 * 1 NA_ 4 Nrc (#####){R}
26 * 2 NA_ 4 Height (##.###){R}
27 * 3 NA_ 4 CIMin (##.###){R}
28 * 4 NA_ 4 CIMax (##.###){R}
29 * 5 NA_ 4 OrHght (##.###){R}
30 * 6 NA_ 4 HDiff (##.###) Height-OrHght{R}
31 * 7 NA_ 4 CIW (##.###) CIMax-CIMin{R}
32 * 8 NA_ 1 OK (#) Height within CI{R}
33 *END{R}
34 *(ull){act}@SCRATCH /{act}
35 + MainLoop: {jump 1,1,1,1}{search}ColH={R}
36 *(find =){r}{print Wj} {Wi=0}
37 /
38 / Starting loop:
39 + Loop: {Wi=Wi+1}
40 / Calling SIMUL.EXE:
41 *(jump 1,1,1,1){search}Mode={R}
42 *(find =){r}{jump Wlin,Wlin,1,1}{d}@SCRATCH /{act}{home}SIMUL {}
43 *(write Wdata),CUR+3,0,70,-100{act}{jump Wlin,Wlin,1,1}{d4}{erase}Col {}
44 *Dr DiamL MaN1 MaP1 DiamU MaN2 MaP2 Height MaN3 MaP3{R}
45 *(save cursor Wlin2,Wcol2){Wflin=Wlin2}{u}{pre}{d}{pre}{d}{u}
46 *(save cursor Wlin2,Wcol2){Wlline=Wlin2}{jump 1,1,1,1}{search}PresDr=
47 *{R}
48 *(find =){r}{ins} {ins}{save word Wpresdr}{l}{del}
49 /
50 / Selecting the preserved drums:
51 *(Wk=0)
52 + Preserved: {jump Wlin,Wlin,1,1}{d2}{erase}int{{print Wflin}+{
53 *(print Wlline)+1-(print Wflin))*rnd(0)}={act}{save line Wlin2}
54 *(jump Wlin2,Wlin2,1,1){save char Whelp1}
55 - if Whelp1 '=' * then goto Preserved
56 **{Wk=Wk+1}
57 - if Wk < Wpresdr then goto Preserved
58 *(jump Wlin,Wlin,1,1){d5}
59 + Del: {save char Whelp1}{next word}{save cursor Wlin2,Wcol2}
60 *(line start)
61 - if Wcol2 = 1 then goto Cont
62 - if Whelp1 '=' * then goto Del2
63 *(del line){goto Del}
64 + Del2: {d}{goto Del}
65 + Cont: {jump Wlin,Wlin,1,1}{d2}{erase}{d}DATA SIMULATX{R}
66 *(d){block}{block}{pre}{d}{pre}{d}{block}{erase}{R}
67 *(d)STAT SIMULATX,CUR+12 / VARS=Height {act}{R}

```

```

37 1 SURVO 84C EDITOR Sat Dec 12 23:23:10 1998          D:\COLMON\ 140 100 G
68 *E=stddev/sqrt(N)*sqrt(1-N/216){R}
69 *L=E*2.001{R}
70 *L1=mean-L 6*L1={act}{ins} {save word WCImIn}{R}
71 *L2=mean+L 6*L2={act} {save word WCImax}{R}
72 *6*mean={act} {save word Wmeanh}{ins}{R}
73 *. {copy}{R}
74 *{R}
75 *DATA DR{R}
76 *Nro Height CIMin CIMax OrHght HDiff CIW OK{R}
77 *(print Wi) (print Wmeanh) (print WCImIn){13} (print WCImax){13} {}
78 *(print Wj){Whelp1=Wmeanh-Wj} (print Whelp1){Whelp1=WCImax-WCImIn} {}
79 *(print Whelp1){13}{erase}{Whelp1=1}
80 - if Wj < WCImIn then goto !OK
81 - if Wj > WCImax then goto !OK else goto OK
82 + !OK: {Whelp1=0}
83 + OK: {print Whelp1}{R}
84 *{R}
85 *FILE COPY DR, (print Wfile){act}
86 /
87 - if Wi < Wrep then goto Loop
88 *(Wj=Wj+Wstep)
89 - if Wj <= Wmax then goto MainLoop
90 + End: {jump Wlin,Wlin,1,1}{tempo +1}{end}
91 *
92 *
93 *EXAMPLE:
94 *All dimensions in meters (Parameters needed for SIMUL.EXE; only
95 * height data used by SIMUNGHT.TUT.)
96 *ColDiamL=1.455 Lower diameter of the column between flutes
97 *DiamVar=0.005 Range of lower diameters (plus and minus)
98 *ColDiamU=1.15 Upper diameter of the column between flutes
99 *ColH=8.98 Column height
100 *MaxEnt=0.01 Maximum entasis
101 *MaxEntH=4.50 Height where the maximum entasis is
102 *ColNFr=6 Number of columns on front
103 *ColNS=8 Number of columns on side
104 *DrN=6 Number of drums in one column
105 *PresDr=60 Number of preserved drums
106 *MinMarg=0.003 Minimum margin for measurements
107 *MaxMarg=0.003 Maximum margin for measurements
108 *Search=ALL Place of possibly matching drums (ALL or number of
109 * adjacent columns where to look for)
110 *Mode=2 0 = Create, select, print and match
111 * 1 = Create, select and print
112 * 2 = Create and print
113 * 3 = Read drum data from the edit field and match
114 *Zcoord=0 0 = No Printing of the drum Z coordinate
115 * 1 = Print the drum Z coordinate
116 *Profile=0 0 = No printing of shaft profile coordinates
117 * 1 = Print the shaft profile coordinates
118 *
119 *DATA DRUMS
120 * Pos MinH MaxH
121 * 0 1.46 1.48
122 * 1 1.46 1.49
123 * 2 1.30 1.73
124 * 3 1.30 1.73
125 * 4 1.30 1.73
126 * 5 1.30 1.73
127 *
128 */SIMUNGHT DRUMS,24,8.76,0.02,8.98,SIMURT24

```

2.A. Colonnade simulation

```

1 1 SURVO 98 Sat Dec 12 23:51:44 1998 D:\COLMON\ 1000 80 C
1 *!SIMUL.EXE
2 *
3 /* !SIMUL.C Oct 10th 1996/Jari Pakkanen */
4 *
5 #include <stdio.h>
6 #include <stdlib.h>
7 #include <conio.h>
8 #include <malloc.h>
9 #include <math.h>
10 #include <time.h>
11 #include "survo.h"
12 #include "survoext.h"
13 #include "survodat.h"
14 *
15 #define DRMAX 14 /* Max number of drums in one column */
16 #define COLMAX 50 /* Max number of columns in the building */
17 #define EPS 0.0001 /* Epsilon value */
18 *
19 #FILE *fpt; /* Filepointer */
20 #SURVO_DATA d;
21 *
22 #double Pos[DRMAX]; /* Position of drum range */
23 #double MinH[DRMAX]; /* Minumum height of drum range */
24 #double MaxH[DRMAX]; /* Maximum height of drum range */
25 #double ColDiamL; /* Lower diameter of the column between flutes */
26 #double DiamVar; /* Range of lower diameters (plus and minus) */
27 #double ColDiamU; /* Upper Diameter of the column between flutes */
28 #double ColH; /* Column height */
29 #int ColNF; /* Number of columns on front */
30 #int ColNS; /* Number of columns on side */
31 #int DrN; /* Number of drums in one column */
32 #int PresDr; /* Number of preserved drums */
33 #double MinMarg; /* Minimum margin for measurements */
34 #double MaxMarg; /* Maximum margin for measurements */
35 #char *Search; /* Place of possibly matching drums */
36 #int search; /* Number of adjacent drums in search */
37 #int Mode; /* Program mode */
38 #int Zcoord; /* Print drum Z coordinate */
39 #int Profile; /* Print shaft profile coordinates */
40 #double aa; /* Constant of the entasis parabola */
41 #double bb; /* Coefficient of x of the antasis parabola */
42 #double cc; /* Coefficient of x^2 of the antasis parabola */
43 #int ColN; /* Number of columns */
44 #char txtname[LLENGTH]; /* Name of the output txt-file */
45 #int dc[DRMAX]; /* Drum counter for matching drums */
46 *
47 #struct drum /* drum information */
48 # { int pres; /* drum preserved (0=not pres; 1=preserved) */
49 # double zcoord; /* Z coordinate of the bottom of the drum */
50 # double diaml; /* lower diameter between flutes */
51 # double diamu; /* upper diameter between flutes */
52 # double height; /* height of the drum */
53 # double diamlnmar; /* neg. measurement margin for lower diameter */
54 # double diamlpmar; /* pos. measurement margin for lower diameter */
55 # double diamunmar; /* neg. measurement margin for upper diameter */
56 # double diamupmar; /* pos. measurement margin for upper diameter */
57 # double heightnmar; /* neg. measurement margin for height */
58 # double heightpmar; /* pos. measurement margin for height */
59 # };
60 *
61 #struct colonnade /* colonnade information */
62 # { struct drum dr[DRMAX];
63 # } col[COLMAX];
64 *
65 #int i,j,k,match,minsearch,missing_level,maxsearch,results_line;
66 #long l;
67 #double adj,dd,diff,height,help_i,help_j,random,root1,root2;
68 #char line[LLENGTH];
69 #time_t start;
70 *

```

```

1 1 SURVO 98 Sat Dec 12 23:53:18 1998 D:\COLMON\ 1000 80 G
71 *main(argc,argv)
72 *int argc; char *argv[];
73 * {
74 * if (argc==1) return;
75 * s_init(argv[1]);
76 * if (q<3)
77 * {
78 * sur_print("\nUsage: SIMUL data,output line,<coeff. a>,
      <coeff. b(x)>,<coeff. c(x^2)>");
79 * WAIT; return;
80 * }
81 * results_line=0;
82 * results_line=edline2(word[2],1,1);
83 * if (results_line==0) return;
84 * i=data_open(word[1],&d); if (i<0) return;
85 * i=sp_init(r1+r-1); if (i<0) return;
86 * i=mask(&d); if (i<0) return;
87 *
88 * /* Finding specifications */
89 * i=spfind("Mode");
90 * if (i>=0)
91 * {
92 * Mode=atoi(spb[i]);
93 * if (Mode<0 || Mode>3)
94 * {
95 * sprintf(sbuf,"\nError in specification Mode");
96 * sur_print(sbuf); WAIT; return;
97 * }
98 * }
99 * else
100 * {
101 * sprintf(sbuf,"\nError in specification Mode");
102 * sur_print(sbuf); WAIT; return;
103 * }
104 * i=spfind("Zcoord");
105 * if (i>=0)
106 * {
107 * Zcoord=atoi(spb[i]);
108 * if (Zcoord<0 || Zcoord>1)
109 * {
110 * sprintf(sbuf,"\nError in specification Zcoord");
111 * sur_print(sbuf); WAIT; return;
112 * }
113 * }
114 * else
115 * {
116 * sprintf(sbuf,"\nError in specification Zcoord");
117 * sur_print(sbuf); WAIT; return;
118 * }
119 * i=spfind("Profile");
120 * if (i>=0)
121 * {
122 * Profile=atoi(spb[i]);
123 * if (Profile<0 || Profile>1)
124 * {
125 * sprintf(sbuf,"\nError in specification Profile");
126 * sur_print(sbuf); WAIT; return;
127 * }
128 * }
129 * else
130 * {
131 * sprintf(sbuf,"\nError in specification Profile");
132 * sur_print(sbuf); WAIT; return;
133 * }
134 * i=spfind("ColNFr");
135 * if (i>=0)
136 * {
137 * ColNFr=atoi(spb[i]);
138 * if (ColNFr<1 || ColNFr>12)
139 * {
140 * sprintf(sbuf,"\nError in specification ColNFr");
141 * sur_print(sbuf); WAIT; return;
142 * }

```

```

1 1 SURVO 98 Sun Dec 13 00:08:51 1998 D:\COLMON\ 1000 80 C
143 * )
144 * else
145 * {
146 *     sprintf(sbuf, "\nError in specification ColNPr");
147 *     sur_print(sbuf); WAIT; return;
148 * }
149 * i=spfind("ColNS");
150 * if (i>=0)
151 * {
152 *     ColNS=atoi(spb[i]);
153 *     if (ColNS<1 || ColNS>20)
154 *     {
155 *         sprintf(sbuf, "\nError in specification ColNS");
156 *         sur_print(sbuf); WAIT; return;
157 *     }
158 * }
159 * else
160 * {
161 *     sprintf(sbuf, "\nError in specification ColNS");
162 *     sur_print(sbuf); WAIT; return;
163 * }
164 * i=spfind("DrN");
165 * if (i>=0)
166 * {
167 *     DrN=atoi(spb[i]);
168 *     if (DrN<1 || DrN>DRMAX)
169 *     {
170 *         sprintf(sbuf, "\nError in specification DrN");
171 *         sur_print(sbuf); WAIT; return;
172 *     }
173 * }
174 * else
175 * {
176 *     sprintf(sbuf, "\nError in specification DrN");
177 *     sur_print(sbuf); WAIT; return;
178 * }
179 * i=spfind("Search");
180 * if (i>=0)
181 *     Search=spb[i];
182 * else
183 * {
184 *     sprintf(sbuf, "\nError in specification Search");
185 *     sur_print(sbuf); WAIT; return;
186 * }
187 * if (Mode<3)
188 * {
189 *     i=spfind("ColDiamL");
190 *     if (i>=0)
191 *     {
192 *         ColDiamL=atof(spb[i]);
193 *         if (ColDiamL<0 || ColDiamL>5)
194 *         {
195 *             sprintf(sbuf, "\nError in specification ColDiamL");
196 *             sur_print(sbuf); WAIT; return;
197 *         }
198 *     }
199 * else
200 * {
201 *     sprintf(sbuf, "\nError in specification ColDiamL");
202 *     sur_print(sbuf); WAIT; return;
203 * }
204 * i=spfind("DiamVar");
205 * if (i>=0)
206 * {
207 *     DiamVar=atof(spb[i]);
208 *     if (DiamVar<0 || DiamVar>1)
209 *     {
210 *         sprintf(sbuf, "\nError in specification DiamVar");
211 *         sur_print(sbuf); WAIT; return;
212 *     }
213 * }
214 * else
215 * {

```

```

1 1 SURVO 98 Sun Dec 13 00:10:01 1998 D:\COLMON\ 1000 80 G
216 *      sprintf(sbuf, "\nError in specification DiamVar");
217 *      sur_print(sbuf); WAIT; return;
218 *      }
219 *      i=spfind("ColDiamU");
220 *      if (i>=0)
221 *      {
222 *          ColDiamU=atof(spb[i]);
223 *          if (ColDiamU<0 || ColDiamU>5)
224 *          {
225 *              sprintf(sbuf, "\nError in specification ColDiamU");
226 *              sur_print(sbuf); WAIT; return;
227 *          }
228 *      }
229 *      else
230 *      {
231 *          sprintf(sbuf, "\nError in specification ColDiamU");
232 *          sur_print(sbuf); WAIT; return;
233 *      }
234 *      i=spfind("ColH");
235 *      if (i>=0)
236 *      {
237 *          ColH=atof(spb[i]);
238 *          if (ColH<0 || ColH>20)
239 *          {
240 *              sprintf(sbuf, "\nError in specification ColH");
241 *              sur_print(sbuf); WAIT; return;
242 *          }
243 *      }
244 *      else
245 *      {
246 *          sprintf(sbuf, "\nError in specification ColH");
247 *          sur_print(sbuf); WAIT; return;
248 *      }
249 *      i=spfind("PresDr");
250 *      if (i>=0)
251 *      {
252 *          PresDr=atoi(spb[i]);
253 *          if (PresDr<0 || PresDr>(2*ColNFr+2*(ColNS-2))*DRMAX)
254 *          {
255 *              sprintf(sbuf, "\nError in specification PresDr");
256 *              sur_print(sbuf); WAIT; return;
257 *          }
258 *      }
259 *      else
260 *      {
261 *          sprintf(sbuf, "\nError in specification PresDr");
262 *          sur_print(sbuf); WAIT; return;
263 *      }
264 *      i=spfind("MinMarg");
265 *      if (i>=0)
266 *      {
267 *          MinMarg=atof(spb[i]);
268 *          if (MinMarg<0 || MinMarg>1)
269 *          {
270 *              sprintf(sbuf, "\nError in specification MinMarg");
271 *              sur_print(sbuf); WAIT; return;
272 *          }
273 *      }
274 *      else
275 *      {
276 *          sprintf(sbuf, "\nError in specification MinMarg");
277 *          sur_print(sbuf); WAIT; return;
278 *      }
279 *      i=spfind("MaxMarg");
280 *      if (i>=0)
281 *      {
282 *          MaxMarg=atof(spb[i]);
283 *          if (MaxMarg<0 || MaxMarg>1)
284 *          {
285 *              sprintf(sbuf, "\nError in specification MaxMarg");
286 *              sur_print(sbuf); WAIT; return;
287 *          }
288 *      }

```

```

1 1 SURVO 98 Sun Dec 13 00:11:16 1998 D:\COLMON\ 1000 80 C
288 * }
289 * else
290 * {
291 *     sprintf(sbuf, "\nError in specification MaxMarg");
292 *     sur_print(sbuf); WAIT; return;
293 * }
294 * /* Coefficients of the entasis parabola */
295 * aa=atof(word[3]);
296 * bb=atof(word[4]);
297 * cc=atof(word[5]);
298 * }
299 *
300 * /* Reading data from the edit field */
301 * ColN=2*ColNFr+2*(ColNS-2)-1;
302 * if (Mode<3)
303 * {
304 *     i=0;
305 *     for (l=d.11; l<=d.12; ++l)
306 *     {
307 *         data_load(&d,l,d.v[0], &Pos[i]);
308 *         data_load(&d,l,d.v[1], &MinH[i]);
309 *         data_load(&d,l,d.v[2], &MaxH[i]);
310 *         ++i;
311 *     }
312 * }
313 * else
314 * {
315 *     for (i=0; i<=ColN; ++i)
316 *         for (j=0; j<DrN; ++j)
317 *             col[i].dr[j].pres=0;
318 *     for (l=d.11; l<=d.12; ++l)
319 *     {
320 *         data_load(&d,l,d.v[0], &help_i);
321 *         i=(int)(help_i);
322 *         data_load(&d,l,d.v[1], &help_j);
323 *         j=(int)(help_j);
324 *         data_load(&d,l,d.v[2], &col[i].dr[j].diaml);
325 *         data_load(&d,l,d.v[3], &col[i].dr[j].diamlnmar);
326 *         data_load(&d,l,d.v[4], &col[i].dr[j].diamlpmar);
327 *         data_load(&d,l,d.v[5], &col[i].dr[j].diamu);
328 *         data_load(&d,l,d.v[6], &col[i].dr[j].diamunmar);
329 *         data_load(&d,l,d.v[7], &col[i].dr[j].diamupmar);
330 *         data_load(&d,l,d.v[8], &col[i].dr[j].height);
331 *         data_load(&d,l,d.v[9], &col[i].dr[j].heightnmar);
332 *         data_load(&d,l,d.v[10], &col[i].dr[j].heightpmar);
333 *         if (Zcoord==1)
334 *             data_load(&d,l,d.v[11], &col[i].dr[j].zcoord);
335 *         col[i].dr[j].pres=1;
336 *     }
337 * }
338 * data_close(&d);
339 *
340 * /* CREATING THE COLONNADE */
341 *
342 * if (Mode<3)
343 * {
344 *     srand(time(&start));
345 *     for (i=0; i<=ColN; ++i)
346 *     {
347 *         height=0;
348 *         for (j=0; j<DrN; ++j)
349 *         {
350 *             random=rand()/32768.0;
351 *             col[i].dr[j].height=MinH[j]+(MaxH[j]-MinH[j])*random;
352 *             height=height+col[i].dr[j].height;
353 *         }
354 *         /* Adjusting the drum heights */
355 *         diff=ColH-height;
356 *         if (fabs(diff)>MaxMarg)
357 *             do {
358 *                 j=(int)((DrN-1)*(rand()/32768.0));
359 *                 if (diff<0)
360 *                     if (col[i].dr[j].height+diff>=MinH[j])
361 *                         {

```

```

1 1 SURVO 98 Sun Dec 13 00:11:59 1998 D:\COLMON\ 1000 80 G
362 * col[i].dr[j].height=col[i].dr[j].height+diff;
363 * height=height+diff;
364 * }
365 * else
366 * {
367 * height=height-col[i].dr[j].height;
368 * adj=0.33*(col[i].dr[j].height-MinH[j]);
369 * col[i].dr[j].height=col[i].dr[j].height-adj;
370 * height=height+col[i].dr[j].height;
371 * }
372 * else
373 * if (col[i].dr[j].height+diff<=MaxH[j])
374 * {
375 * col[i].dr[j].height=col[i].dr[j].height+diff;
376 * height=height+diff;
377 * }
378 * else
379 * {
380 * height=height-col[i].dr[j].height;
381 * adj=0.33*(MaxH[j]-col[i].dr[j].height);
382 * col[i].dr[j].height=col[i].dr[j].height+adj;
383 * height=height+col[i].dr[j].height;
384 * }
385 * diff=ColH-height;
386 * | while (fabs(diff)>MaxMarg);
387 * }
388 * /* Rounding heights to millimeters */
389 * for (i=0; i<=ColN; ++i)
390 * for (j=0; j<DrN; ++j)
391 * {
392 * dd=1000*(col[i].dr[j].height)+0.5;
393 * col[i].dr[j].height=(int)(dd)/1000.0;
394 * }
395 * /* Bottom drum diameters */
396 * for (i=0; i<=ColN; ++i)
397 * {
398 * random=rand()/32768.0;
399 * dd=1000*(ColDiamL-DiamVar+2*DiamVar*random)+0.5;
400 * col[i].dr[0].diaml=(int)(dd)/1000.0;
401 * col[i].dr[0].zcoord=0.0;
402 * height=col[i].dr[0].height;
403 * root1=(-bb+sqrt(bb*bb-(4*cc*(aa-height))))/(2*cc);
404 * root2=(-bb-sqrt(bb*bb-(4*cc*(aa-height))))/(2*cc);
405 * if (fabs(root1)<=fabs(root2)) diff=root1;
406 * else diff=root2;
407 * dd=1000*(col[i].dr[0].diaml-2*diff)+0.5;
408 * col[i].dr[0].diamu=(int)(dd)/1000.0;
409 * /* Measurement margins */
410 * random=rand()/32768.0;
411 * dd=1000*(MinMarg+(MaxMarg-MinMarg)*random)+0.5;
412 * col[i].dr[0].heightpmar=(int)(dd)/1000.0;
413 * col[i].dr[0].heightrmar=-col[i].dr[0].heightpmar;
414 * random=rand()/32768.0;
415 * dd=1000*(MinMarg+(MaxMarg-MinMarg)*random)+0.5;
416 * col[i].dr[0].diamlpmar=(int)(dd)/1000.0;
417 * col[i].dr[0].diamrmar=-col[i].dr[0].diamlpmar;
418 * random=rand()/32768.0;
419 * dd=1000*(MinMarg+(MaxMarg-MinMarg)*random)+0.5;
420 * col[i].dr[0].diamupmar=(int)(dd)/1000.0;
421 * col[i].dr[0].diamunmar=-col[i].dr[0].diamupmar;
422 * }
423 * /* Diameters of other drums */
424 * for (i=0; i<=ColN; ++i)
425 * {
426 * height=col[i].dr[0].height;
427 * for (j=1; j<DrN; ++j)
428 * {
429 * col[i].dr[j].zcoord=height;
430 * height=height+col[i].dr[j].height;
431 * root1=(-bb+sqrt(bb*bb-(4*cc*(aa-height))))/(2*cc);
432 * root2=(-bb-sqrt(bb*bb-(4*cc*(aa-height))))/(2*cc);
433 * if (fabs(root1)<=fabs(root2)) diff=root1;
434 * else diff=root2;

```

```

1 1 SURVO 98 Sun Dec 13 00:12:45 1998 D:\COLMON\ 1000 80 C
435 * col[i].dr[j].diaml=col[i].dr[j-1].diamu;
436 * dd=1000*(col[i].dr[0].diaml-2*diff)+0.5;
437 * col[i].dr[j].diamu=(int)(dd)/1000.0;
438 * /* Measurement margins */
439 * random=rand()/32768.0;
440 * dd=1000*(MinMarg+(MaxMarg-MinMarg)*random)+0.5;
441 * col[i].dr[j].heightpmar=(int)(dd)/1000.0;
442 * col[i].dr[j].heightnmar=-col[i].dr[j].heightpmar;
443 * random=rand()/32768.0;
444 * dd=1000*(MinMarg+(MaxMarg-MinMarg)*random)+0.5;
445 * col[i].dr[j].diamlpmar=(int)(dd)/1000.0;
446 * col[i].dr[j].diamlnmar=-col[i].dr[j].diamlpmar;
447 * random=rand()/32768.0;
448 * dd=1000*(MinMarg+(MaxMarg-MinMarg)*random)+0.5;
449 * col[i].dr[j].diamupmar=(int)(dd)/1000.0;
450 * col[i].dr[j].diamunmar=-col[i].dr[j].diamupmar;
451 * }
452 * }
453 * }
454 *
455 * /* SELECTING PRESERVED DRUMS */
456 *
457 * if (Mode<2)
458 * {
459 *   for (i=0; i<=ColN; ++i)
460 *     for (j=0; j<DrN; ++j)
461 *       col[i].dr[j].pres=0;
462 *   k=0;
463 *   do {
464 *     i=(int)((ColN+1)*(rand()/32768.0));
465 *     j=(int)((DrN)*(rand()/32768.0));
466 *     if (col[i].dr[j].pres==0)
467 *     {
468 *       col[i].dr[j].pres=1;
469 *       k++;
470 *     }
471 *   } while (k<PresDr);
472 * }
473 * else
474 *   if (Mode==2)
475 *     for (i=0; i<=ColN; ++i)
476 *       for (j=0; j<DrN; ++j)
477 *         col[i].dr[j].pres=1;
478 *
479 * /* PAIRS OF TRULY MATCHING DRUMS */
480 *
481 * if (Mode<2)
482 * {
483 *   k=0;
484 *   for (i=0; i<=ColN; ++i)
485 *     for (j=0; j<DrN-1; ++j)
486 *       if (col[i].dr[j].pres==1 && col[i].dr[j+1].pres==1)
487 *         ++k;
488 * }
489 *
490 * /* OUTPUT OF DATA TO EDIT FIELD */
491 *
492 * output_open(eout);
493 * if (Mode<3)
494 * {
495 *   if (Mode<2)
496 *   {
497 *     sprintf(line,"Number of truly matching pairs: %i", k);
498 *     print_line(line);
499 *   }
500 *   if (Zcoord==0)
501 *     strcpy(line,"Col Dr DiamL -Mar Mar DiamU -Mar Mar
502 *               Height -Mar Mar");
503 *   else
504 *     strcpy(line,
505 *            "Col Dr DiamL -Mar Mar DiamU -Mar Mar Height
506 *            Height -Mar Mar Zcoord");
507 *   print_line(line);

```

```

1 1 SURVO 98 Sun Dec 13 00:35:50 1998 D:\COLMON\ 1000 80 G
506 * for (j=0; j<DrN; ++j)
507 *     for (i=0; i<=ColN; ++i)
508 *         if (col[i].dr[j].pres==1)
509 *             if (Zcoord==0)
510 *                 {
511 *                     sprintf(line,
512 *                         "%3i %2i %7.3f %6.3f %5.3f %7.3f %6.3f %5.3f
513 *                         %7.3f %6.3f %5.3f",
514 *                         i, j, col[i].dr[j].diaml, col[i].dr[j].diamlnmar,
515 *                         col[i].dr[j].diamlpmar, col[i].dr[j].diamu,
516 *                         col[i].dr[j].diamunmar, col[i].dr[j].diamupmar,
517 *                         col[i].dr[j].height, col[i].dr[j].heightnmar,
518 *                         col[i].dr[j].heightpmar);
519 *                     print_line(line);
520 *                 }
521 *             else
522 *                 {
523 *                     sprintf(line,
524 *                         "%3i %2i %7.3f %6.3f %5.3f %7.3f %6.3f %5.3f
525 *                         %7.3f %6.3f %5.3f %6.3f",
526 *                         i, j, col[i].dr[j].diaml, col[i].dr[j].diamlnmar,
527 *                         col[i].dr[j].diamlpmar, col[i].dr[j].diamu,
528 *                         col[i].dr[j].diamunmar, col[i].dr[j].diamupmar,
529 *                         col[i].dr[j].height, col[i].dr[j].heightnmar,
530 *                         col[i].dr[j].heightpmar, col[i].dr[j].zcoord);
531 *                     print_line(line);
532 *                 }
533 *     }
534 *
535 * /* MATCHING DRUMS */
536 *
537 * if (Mode==0 || Mode==3)
538 *     {
539 *         sprintf(txtname, "%s%.txt", edisk, word[1]);
540 *         fpt=fopen(txtname, "w");
541 *         missing_level=0;
542 *         for (j=0; j<=DrN-1; ++j)
543 *             {
544 *                 k=0;
545 *                 for (i=0; i<=ColN; ++i)
546 *                     if (col[i].dr[j].pres==1) ++k;
547 *                 if (k==0) missing_level=1;
548 *             }
549 *         if (!missing_level)
550 *             {
551 *                 strcpy(line, Search);
552 *                 i=strlen(line);
553 *                 if (i<3) /* Limited search */
554 *                     {
555 *                         search=atoi(Search);
556 *                         i=-1;
557 *                         do ++i; while (col[i].dr[0].pres==0 && i<=ColN);
558 *                         if (i<=ColN)
559 *                             {
560 *                                 maxsearch=i+search;
561 *                                 if (maxsearch>ColN) maxsearch=maxsearch-ColN-1;
562 *                                 minsearch=i-search;
563 *                                 if (minsearch<0) minsearch=ColN+minsearch+1;
564 *                                 k=first_path_lim_search();
565 *                                 if (k==0)
566 *                                     {
567 *                                         strcpy(line, "No matching complete columns.");
568 *                                         print_line(line);
569 *                                     }
570 *                                 else
571 *                                     {
572 *                                         print_to_file();
573 *                                         do {
574 *                                             k=find_path_lim_search();
575 *                                             if (k!=0) print_to_file();
576 *                                         } while (k!=0);
577 *                                     }
578 *                             }
579 *                     }
580 *             }
581 *         else
582 *             {

```



```

1 1 SURVO 98 Sun Dec 13 00:36:31 1998 D:\COLMON\ 1000 80 C
579 * strcpy(line,"No matching complete columns.");
580 * print_line(line);
581 * }
582 * }
583 * else /* Search all */
584 * {
585 * i=-1;
586 * do ++i; while (col[i].dr[0].pres==0 && i<=ColN);
587 * if (i<=ColN)
588 * {
589 * minsearch=0;
590 * k=first_path_all();
591 * if (k==0)
592 * {
593 * strcpy(line,"No matching complete columns.");
594 * print_line(line);
595 * }
596 * else
597 * {
598 * print_to_file();
599 * do {
600 * k=find_path_all();
601 * if (k!=0) print_to_file();
602 * } while (k!=0);
603 * }
604 * }
605 * else
606 * {
607 * strcpy(line,"No matching complete columns.");
608 * print_line(line);
609 * }
610 * }
611 * }
612 * else
613 * {
614 * strcpy(line,"No matching complete columns.");
615 * print_line(line);
616 * }
617 * fclose(fpt);
618 * }
619 * output_close(eout);
620 * }
621 *
622 *print_line(line)
623 *char *line;
624 * {
625 * output_line(line,eout,results_line);
626 * if (results_line) ++results_line;
627 * }
628 *
629 *print_to_file()
630 * {
631 * int i;
632 * double height,height_neg_mar,height_pos_mar,prof_coor;
633 * char line2[LLENGTH];
634 *
635 * if (Profile==1)
636 * {
637 * fprintf(fpt,"%i,0,", dc[0]);
638 * height=col[dc[0]].dr[0].height;
639 * height_neg_mar=col[dc[0]].dr[0].heightmar;
640 * height_pos_mar=col[dc[0]].dr[0].heightpmar;
641 * prof_coor=col[dc[0]].dr[0].diaml/2-(col[dc[0]].dr[0].diamu
        +col[dc[1]].dr[1].diaml)/4;
642 * fprintf(fpt,"%f,%f,", prof_coor,height);
643 * for (i=1; i<DrN-1; ++i)
644 * {
645 * fprintf(fpt,"%i,%i,", dc[i], i);
646 * height=height+col[dc[i]].dr[i].height;
647 * height_neg_mar=height_neg_mar+col[dc[i]].dr[i].heightmar;
648 * height_pos_mar=height_pos_mar+col[dc[i]].dr[i].heightpmar;
649 * prof_coor=col[dc[0]].dr[0].diaml/2-(col[dc[i]].dr[i].diamu
        +col[dc[1]].dr[1].diaml)/4;

```

```

1 1 SURVO 98 Sun Dec 13 00:37:42 1998 D:\COLMON\ 1000 80 G
650 *      fprintf(fpt,"%f,%f,", prof_coor,height);
651 *    }
652 *    i=DrN-1;
653 *    fprintf(fpt,"%i,%i,", dc[i], i);
654 *    height=height+col[dc[i]].dr[i].height;
655 *    height_neg_mar=height_neg_mar+col[dc[i]].dr[i].heightnmar;
656 *    height_pos_mar=height_pos_mar+col[dc[i]].dr[i].heightpmar;
657 *    prof_coor=(col[dc[0]].dr[0].diaml-col[dc[i]].dr[i].diamu)/2;
658 *    fprintf(fpt,"%f,%f,%f,%f\n", prof_coor,height,height_neg_mar,
        height_pos_mar);
659 *  }
660 *  else
661 *  {
662 *    fprintf(fpt,"%i,0,", dc[0]);
663 *    height=col[dc[0]].dr[0].height;
664 *    height_neg_mar=col[dc[0]].dr[0].heightnmar;
665 *    height_pos_mar=col[dc[0]].dr[0].heightpmar;
666 *    for (i=1; i<DrN-1; ++i)
667 *    {
668 *      fprintf(fpt,"%i,%i,", dc[i], i);
669 *      height=height+col[dc[i]].dr[i].height;
670 *      height_neg_mar=height_neg_mar+col[dc[i]].dr[i].heightnmar;
671 *      height_pos_mar=height_pos_mar+col[dc[i]].dr[i].heightpmar;
672 *    }
673 *    i=DrN-1;
674 *    fprintf(fpt,"%i,%i,", dc[i], i);
675 *    height=height+col[dc[i]].dr[i].height;
676 *    height_neg_mar=height_neg_mar+col[dc[i]].dr[i].heightnmar;
677 *    height_pos_mar=height_pos_mar+col[dc[i]].dr[i].heightpmar;
678 *    fprintf(fpt,"%f,%f,%f\n", height,height_neg_mar,height_pos_mar);
679 *  }
680 *  }
681 *
682 */* FINDING THE FIRST PATH IN LIMITED SEARCH */
683 *
684 *first_path_lim_search()
685 * {
686 *   /* NOT IMPLEMENTED */
687 * }
688 *
689 */* FINDING THE NEXT PATH IN LIMITED SEARCH */
690 *
691 *find_path_lim_search()
692 * {
693 *   /* NOT IMPLEMENTED */
694 * }
695 *
696 */* FINDING THE FIRST PATH IN SEARCHING ALL POSSIBILITIES */
697 *
698 *first_path_all()
699 * {
700 *   int column,dead_end,i0,i1,j0,k0,more_drums,no_match;
701 *   double maxlower,maxupper,minlower,minupper;
702 *
703 *   column=0;
704 *   dc[0]=i;
705 *   for (j0=1; j0<DrN; ++j0)
706 *     dc[j0]=-1;
707 *   do {
708 *     i0=i; j0=0; dead_end=0;
709 *     do {
710 *       i1=minsearch; no_match=1;
711 *       do {
712 *         if (col[i0].dr[j0].pres==1 && col[i1].dr[j0+1].pres==1)
713 *         {
714 *           minlower=col[i0].dr[j0].diamu+col[i0].dr[j0].diamnmar;
715 *           maxlower=col[i0].dr[j0].diamu+col[i0].dr[j0].diamupmar;
716 *           minupper=col[i1].dr[j0+1].diaml
              +col[i1].dr[j0+1].diamlnmar;
717 *           maxupper=col[i1].dr[j0+1].diaml
              +col[i1].dr[j0+1].diamlpmar;
718 *           if ((minlower-maxupper)>EPS || EPS<(minupper-maxlower))
719 *             ++i1;

```

```

1 1 SURVO 98 Sun Dec 13 00:38:33 1998 D:\COLMON\ 1000 80 C
720 *         else
721 *         {
722 *             no_match=0;
723 *             dc[j0+1]=i1;
724 *             i0=i1;
725 *             i0=i1;
726 *         }
727 *         else ++i1;
728 *         } while (no_match && i1<=ColN);
729 *         if (!no_match)
730 *         {
731 *             ++j0; minsearch=0;
732 *             if (j0==DrN-1) column=1;
733 *         }
734 *         else
735 *         {
736 *             if (j0==0) dead_end=1;
737 *             if (j0>0 && j0<DrN-1)
738 *             {
739 *                 more_drums=0; k0=dc[j0];
740 *                 do ++k0; while (col[k0].dr[j0].pres==0 && k0<=ColN);
741 *                 if (k0<=ColN) more_drums=1;
742 *                 if (more_drums)
743 *                 {
744 *                     minsearch=k0;
745 *                     if (j0>1) dc[j0]=-1;
746 *                     if (j0>0) --j0;
747 *                     i0=dc[j0];
748 *                 }
749 *             }
750 *             else
751 *             {
752 *                 do {
753 *                     if (j0>1) dc[j0]=-1;
754 *                     --j0; k0=dc[j0];
755 *                     do ++k0; while (col[k0].dr[j0].pres==0 &&
756 *                                     k0<=ColN);
757 *                     if (k0<=ColN) more_drums=1;
758 *                     } while (!more_drums && j0>1);
759 *                     if (j0>1) dc[j0]=-1;
760 *                     if (j0>0) --j0;
761 *                     i0=dc[j0];
762 *                     if (more_drums) minsearch=k0;
763 *                     else minsearch=0;
764 *                 }
765 *             }
766 *             if (j0<1)
767 *             {
768 *                 i0=dc[0];
769 *                 k0=dc[1];
770 *                 do ++k0; while (col[k0].dr[1].pres==0 && k0<=ColN);
771 *                 if (k0>ColN) dead_end=1;
772 *                 else minsearch=k0;
773 *             }
774 *         }
775 *         } while (j0<DrN-1 && !dead_end);
776 *         if (column==0)
777 *         {
778 *             do ++i; while (col[i].dr[0].pres==0 && i<=ColN);
779 *             minsearch=0;
780 *             dc[0]=i;
781 *             for (j0=1; j0<DrN; ++j0)
782 *                 dc[j0]=-1;
783 *         } while (column==0 && i<=ColN);
784 *         return(column);
785 *     }
786 * /* FINDING THE NEXT PATH IN SEARCHING ALL POSSIBILITIES */
787 *
788 * find_path_all()
789 * {
790 *     int column,dead_end,i0,i1,j0,k0,more_drums,no_match;
791 *     double maxlower,maxupper,minlower,minupper;

```

```

1 1 SURVO 98 Sun Dec 13 00:39:09 1998 D:\COLMON\ 1000 80 G
792 *
793 * column=0; j0=DrN-1; more_drums=0; dead_end=0;
794 * k0=dc[j0];
795 * do ++k0; while (col[k0].dr[j0].pres==0 && k0<=ColN);
796 * if (k0<=ColN) more_drums=1;
797 * if (more_drums)
798 * {
799 * minsearch=k0;
800 * if (j0>1) dc[j0]=-1;
801 * if (j0>0) --j0;
802 * i0=dc[j0];
803 * }
804 * else
805 * {
806 * do {
807 * if (j0>1) dc[j0]=-1;
808 * --j0; k0=dc[j0];
809 * do ++k0; while (col[k0].dr[j0].pres==0 && k0<=ColN);
810 * if (k0<=ColN) more_drums=1;
811 * } while (!more_drums && j0>1);
812 * if (j0>1) dc[j0]=-1;
813 * if (j0>0) --j0;
814 * i0=dc[j0];
815 * if (more_drums) minsearch=k0;
816 * else minsearch=0;
817 * }
818 * if (j0<1)
819 * {
820 * i0=dc[0];
821 * k0=dc[1];
822 * do ++k0; while (col[k0].dr[1].pres==0 && k0<=ColN);
823 * if (k0>ColN)
824 * {
825 * do ++i; while (col[i].dr[0].pres==0 && i<=ColN);
826 * if (i>ColN) dead_end=1;
827 * else
828 * {
829 * minsearch=0;
830 * dc[0]=i;
831 * for (j0=1; j0<DrN; ++j0)
832 * dc[j0]=-1;
833 * i0=i; j0=0;
834 * }
835 * }
836 * else minsearch=k0;
837 * }
838 * if (!dead_end)
839 * do {
840 * dead_end=0;
841 * do {
842 * i1=minsearch; no_match=1;
843 * do {
844 * if (col[i0].dr[j0].pres==1 && col[i1].dr[j0+1].pres==1)
845 * {
846 * minlower=col[i0].dr[j0].diamu
847 * +col[i0].dr[j0].diamunmar;
848 * maxlower=col[i0].dr[j0].diamu
849 * +col[i0].dr[j0].diamupmar;
850 * minupper=col[i1].dr[j0+1].diaml
851 * +col[i1].dr[j0+1].diamlnmar;
852 * maxupper=col[i1].dr[j0+1].diaml
853 * +col[i1].dr[j0+1].diamlpmar;
854 * if ((minlower-maxupper)>EPS || EPS<(minupper
855 * -maxlower))
856 * ++i1;
857 * else
858 * {
859 * no_match=0;
860 * dc[j0+1]=i1;
861 * i0=i1;
862 * }
863 * }
864 * }

```

```

1 1 SURVO 98 Sun Dec 13 00:39:51 1998 D:\COLMON\ 1000 80 C
859 *         else ++i1;
860 *         } while (no_match && i1<=ColN);
861 *     if (!no_match)
862 *     {
863 *         ++j0; minsearch=0;
864 *         if (j0==DrN-1) column=1;
865 *     }
866 *     else
867 *     {
868 *         if (j0==0) dead_end=1;
869 *         if (j0>0 && j0<DrN-1)
870 *         {
871 *             more_drums=0; k0=dc[j0];
872 *             do ++k0; while (col[k0].dr[j0].pres==0 && k0<=ColN);
873 *             if (k0<=ColN) more_drums=1;
874 *             if (more_drums)
875 *             {
876 *                 minsearch=k0;
877 *                 if (j0>1) dc[j0]=-1;
878 *                 if (j0>0) --j0;
879 *                 i0=dc[j0];
880 *             }
881 *             else
882 *             {
883 *                 do {
884 *                     if (j0>1) dc[j0]=-1;
885 *                     --j0; k0=dc[j0];
886 *                     do ++k0; while (col[k0].dr[j0].pres==0 &&
887 *                                     k0<=ColN);
888 *                     if (k0<=ColN) more_drums=1;
889 *                 } while (!more_drums && j0>1);
890 *                 if (j0>1) dc[j0]=-1;
891 *                 if (j0>0) --j0;
892 *                 i0=dc[j0];
893 *                 if (more_drums) minsearch=k0;
894 *                 else minsearch=0;
895 *             }
896 *             if (j0<1)
897 *             {
898 *                 i0=dc[0];
899 *                 k0=dc[1];
900 *                 do ++k0; while (col[k0].dr[1].pres==0 &&
901 *                                     k0<=ColN);
902 *                 if (k0>ColN) dead_end=1;
903 *                 else minsearch=k0;
904 *             }
905 *         } while (j0<DrN-1 && !dead_end);
906 *     if (column==0)
907 *     {
908 *         do ++i; while (col[i].dr[0].pres==0 && i<=ColN);
909 *         minsearch=0;
910 *         dc[0]=i;
911 *         for (j0=1; j0<DrN; ++j0)
912 *             dc[j0]=-1;
913 *     }
914 *     i0=i; j0=0;
915 *     } while (column==0 && i<=ColN);
916 * return(column);
917 * }
918 *

```

```

20 1 SURVO 84C EDITOR Sun Dec 13 19:27:12 1998      D:\COLMON\ 200 100 G
1 *EXAMPLE:
2 *ColDiamL=1.455      Lower diameter of the column between flutes
3 *DiamVar=0.005      Range of lower diameters (plus and minus)
4 *ColDiamU=1.15      Upper diameter of the column between flutes
5 *ColH=8.97          Column height
6 *MaxEnt=0.01        Maximum entasis
7 *MaxEntH=4.49       Height where the maximum entasis is
8 *ColNFr=6           Number of columns on front
9 *ColNS=14           Number of columns on side
10 *DrN=6              Number of drums in one column
11 *PresDr=50          Number of preserved drums
12 *MinMarg=0.002     Minimum margin for measurements
13 *MaxMarg=0.003     Maximum margin for measurements
14 *Search=ALL         Place of possibly matching drums (ALL or number of
15 *                   adjacent columns where to look for)
16 *Node=3            0 = Create, select, print and match
17 *                   1 = Create, select and print
18 *                   2 = Create and print
19 *                   3 = Read drum data from the edit field and match
20 *Zcoord=0          0 = No Printing of the drum Z coordinate
21 *                   1 = Print the drum Z coordinate
22 *Profile=1         0 = No printing of shaft profile coordinates
23 *                   1 = Print the shaft profile coordinates
24 *
25 *SIMUL TEGEADR,CUR+1_
26 *
27 *DATA TEGEADR
28 *Col Dr   DiamL   MaN1   MaP1   DiamU   MaN2   MaP2   Height   MaN3   MaP3
29 A 1 0  1.458 -0.004 0.004  1.412 -0.002 0.002  1.465 -0.009 0.009
30 * 2 0  1.453 -0.004 0.004  1.421 -0.004 0.004  1.469 -0.007 0.005
31 * 3 0  1.459 -0.004 0.003  1.420 -0.002 0.001  1.472 -0.003 0.003
32 * 5 0  1.458 -0.003 0.003  1.422 -0.002 0.001  1.474 -0.002 0.002
33 * 7 0  1.455 -0.003 0.003  1.416 -0.003 0.003  1.472 -0.003 0.002
34 * 1 1  1.419 -0.001 0.002  1.373 -0.004 0.003  1.464 -0.001 0.002
35 * 2 1  1.421 -0.002 0.002  1.380 -0.003 0.003  1.472 -0.003 0.002
36 * 3 1  1.414 -0.002 0.002  1.376 -0.004 0.004  1.481 -0.004 0.004
37 * 4 1  1.423 -0.004 0.004  1.375 -0.004 0.004  1.476 -0.005 0.005
38 * 5 1  1.418 -0.002 0.002  1.370 -0.005 0.005  1.478 -0.004 0.004
39 * 6 1  1.426 -0.003 0.003  1.379 -0.003 0.003  1.482 -0.003 0.003
40 * 7 1  1.423 -0.003 0.003  1.377 -0.003 0.003  1.469 -0.003 0.003
41 * 8 1  1.421 -0.003 0.003  1.377 -0.003 0.003  1.474 -0.003 0.003
42 * 9 1  1.420 -0.003 0.003  1.370 -0.003 0.003  1.484 -0.003 0.002
43 * 10 1  1.418 -0.002 0.002  1.376 -0.002 0.002  1.473 -0.003 0.002
44 * 11 1  1.417 -0.003 0.003  1.374 -0.003 0.003  1.477 -0.002 0.002
45 * 12 1  1.418 -0.002 0.002  1.377 -0.003 0.003  1.478 -0.002 0.002
46 * 1 2  1.375 -0.003 0.003  1.322 -0.002 0.003  1.668 -0.004 0.003
47 * 2 2  1.375 -0.003 0.003  1.337 -0.004 0.003  1.399 -0.005 0.005
48 * 3 2  1.377 -0.002 0.001  1.332 -0.004 0.004  1.444 -0.003 0.002
49 * 4 2  1.371 -0.003 0.003  1.322 -0.003 0.003  1.479 -0.004 0.003
50 * 5 2  1.378 -0.003 0.003  1.325 -0.003 0.003  1.643 -0.001 0.001
51 * 6 2  1.374 -0.003 0.003  1.328 -0.003 0.003  1.413 -0.003 0.002
52 * 7 2  1.378 -0.002 0.002  1.323 -0.003 0.003  1.498 -0.002 0.002
53 * 8 2  1.375 -0.003 0.003  1.338 -0.003 0.002  1.321 -0.003 0.002
54 * 9 2  1.379 -0.002 0.001  1.329 -0.002 0.001  1.510 -0.002 0.002
55 * 10 2  1.365 -0.005 0.005  1.332 -0.002 0.002  1.457 -0.003 0.002
56 * 1 3  1.331 -0.003 0.002  1.270 -0.003 0.002  1.658 -0.003 0.002
57 * 2 3  1.323 -0.002 0.003  1.267 -0.004 0.004  1.514 -0.002 0.002
58 * 3 3  1.328 -0.002 0.001  1.280 -0.004 0.004  1.480 -0.002 0.001
59 * 4 3  1.326 -0.004 0.003  1.269 -0.003 0.002  1.493 -0.002 0.002
60 * 5 3  1.331 -0.002 0.002  1.271 -0.003 0.002  1.708 -0.002 0.001
61 * 7 3  1.326 -0.003 0.003  1.274 -0.003 0.003  1.447 -0.003 0.003
62 * 8 3  1.321 -0.003 0.003  1.268 -0.002 0.002  1.448 -0.002 0.002
63 * 1 4  1.264 -0.004 0.004  1.212 -0.003 0.003  1.382 -0.010 0.010
64 * 2 4  1.279 -0.002 0.002  1.216 -0.003 0.002  1.662 -0.002 0.001
65 * 3 4  1.272 -0.003 0.002  1.210 -0.002 0.002  1.580 -0.002 0.001
66 * 4 4  1.274 -0.003 0.003  1.216 -0.002 0.002  1.411 -0.003 0.003
67 * 5 4  1.268 -0.003 0.002  1.212 -0.001 0.001  1.368 -0.001 0.001
68 * 6 4  1.268 -0.003 0.003  1.218 -0.003 0.003  1.347 -0.003 0.003
69 * 7 4  1.274 -0.002 0.002  1.223 -0.002 0.002  1.356 -0.002 0.002
70 * 1 5  1.214 -0.003 0.003  1.151 -0.004 0.003  1.326 -0.003 0.003

```

E24 *The Temple of Athena Alea at Tegea*

```

20 1 SURVO 84C EDITOR Sun Dec 13 19:28:09 1998 D:\COLMON\ 200 100 C
71 * 2 5 1.215 -0.003 0.003 1.158 -0.003 0.003 1.331 -0.005 0.005
72 * 3 5 1.209 -0.003 0.003 1.156 -0.002 0.001 1.479 -0.001 0.001
73 * 4 5 1.206 -0.004 0.004 1.155 -0.003 0.003 1.349 -0.006 0.004
74 * 5 5 1.220 -0.002 0.002 1.154 -0.003 0.003 1.500 -0.003 0.005
75 B 6 5 1.215 -0.002 0.002 1.158 -0.003 0.003 1.484 -0.005 0.004
76 *
77 *FILE CREATE TEGEADR
78 *FIELDS:
79 * 1 NA 1 CA (##)
80 * 2 NA 1 DA (##)
81 * 3 NA 4 XA (##.###)
82 * 4 NA 4 YA (##.###)
83 * 5 NA 1 CB (##)
84 * 6 NA 1 DB (##)
85 * 7 NA 4 XB (##.###)
86 * 8 NA 4 YB (##.###)
87 * 9 NA 1 CC (##)
88 * 10 NA 1 DC (##)
89 * 11 NA 4 XC (##.###)
90 * 12 NA 4 YC (##.###)
91 * 13 NA 1 CD (##)
92 * 14 NA 1 DD (##)
93 * 15 NA 4 XD (##.###)
94 * 16 NA 4 YD (##.###)
95 * 17 NA 1 CE (##)
96 * 18 NA 1 DE (##)
97 * 19 NA 4 XE (##.###)
98 * 20 NA 4 YE (##.###)
99 * 21 NA 1 CF (##)
100 * 22 NA 1 DF (##)
101 * 23 NA 4 XF (##.###)
102 * 24 NA 4 Height (##.###)
103 * 25 NA 4 NegMarg (##.###)
104 * 26 NA 4 PosMarg (#.###)
105 * 27 NA 4 Hmin (##.###)
106 * 28 NA 4 Hmax (##.###)
107 *END
108 *
109 *FILE SAVE TEGEADR.TXT,TEGEADR.SVO
110 *FIELDS:
111 * 1 CA
112 * 2 DA
113 * 3 XA
114 * 4 YA
115 * 5 CB
116 * 6 DB
117 * 7 XB
118 * 8 YB
119 * 9 CC
120 *10 DC
121 *11 XC
122 *12 YC
123 *13 CD
124 *14 DD
125 *15 XD
126 *16 YD
127 *17 CE
128 *18 DE
129 *19 XE
130 *20 YE
131 *21 CF
132 *22 DF
133 *23 XF
134 *24 Height
135 *25 NegMarg
136 *26 PosMarg LF
137 *END
138 *
139 *FILE SHOW TEGEADR

```

2.B. Acceptable Shaft Profiles and Maximum Entasis

```

1 1 SURVO 84C EDITOR Sun Dec 13 19:35:10 1998      D:\COLMON\ 400 100 G
1 *SHAFT-MAXENT.TUT
2 *
3 *tutload shaft-maxent
4 / Sucro shaft-maxent.tut by Jari Pakkanen (Mar 31 1997)
5 / for finding the place of maximum entasis in a column shaft.
6 *(tempo -1){init}
7 - if W1 '<>' ? then goto A
8 *(line start){d}{erase}{erase}Activating sucro{R}
9 *(erase){erase}/SHAFT-MAXENT <data>,<ID1>,<ID2>,<emin>,<emax>,<ehmin>,<ehmax><acc>{R}
10 *
11 *(erase){erase}determines whether shaft profile fits into the defined {}
12 *area.{R}
13 *(erase){erase}ID1 is the lower limit of the shaft ID, ID2 the upper, {}
14 *emin and emax{R}
15 *(erase){erase}are the centre of the minimum and maximum entases in m,
16 * ehmin and ehmax{R}
17 *(erase){erase}give the proportional height of the minimum and maximum
18 * entasis and {R}
19 *(erase){erase}acc defines the width of the area in m. The number of f
20 *itting shaft {R}
21 *(erase){erase}profiles for each case are stored in data file SHAFTFIT
22 *.SVO.
23 / def Wdata=W1 Wid1=W2 Wid2=W3 Wentmin=W4 Wentmax=W5 Wenthmin=W6
24 / def Wenthmax=W7 Waccu=W8 Whelp1=W9 Wi=W10 Wj=W11 Wlin=W12 Wcol=W13
25 /
26 + A: {save cursor Wlin,Wcol}{R}
27 *$SCRATCH /{act}{home}FILE CREATE SHAFTFIT{R}
28 *FIELDS:{R}
29 * 1 NA 4 EntH (#.##){R}
30 * 2 NA 4 MaxEnt (#.###){R}
31 * 3 NA 4 N (#####){R}
32 *END{R}
33 *(u6){act}{Wj=Wenthmin}
34 + MainLoop: {jump Wlin,Wlin,1,1}{R}
35 *$SCRATCH /{act}{home}{Wi=Wentmin}
36 /
37 / Starting loop:
38 + Loop: {jump Wlin,Wlin,1,1}{R}
39 *$SCRATCH /{act}{home}
40 / Calling SHAFT-CURVE.TUT
41 *(save stack helpstck)/SHAFT-CURVE {print Wdata},{print Wid1},
42 *(print Wid2},{Whelp1=Wi+Waccu}{print Whelp1},{Whelp1=Wi-Waccu}
43 *(print Whelp1},{print Wj},{print Waccu}{tempo +1}{act}{tempo -1}
44 *(load stack helpstck){R}
45 *$SCRATCH /{act}{home}IND=OK,1{R}
46 *STAT {print Wdata},CUR+1 / VARS=Height{act}{R}
47 *(find =){r}{save line Whelp1}{jump Wlin,Wlin,1,1}{R}
48 *$SCRATCH /{act}{home}DATA FITTING{R}
49 *EntH MaxEnt N{R}
50 *(print Wj) {print Wi} {print Whelp1}{R}
51 *(d)VAR OK=0 TO {print Wdata}{act}{home}{erase}SAVEP C:\E\RESULTS{act}
52 *(home){erase}FILE COPY FITTING,SHAFTFIT{act}
53 /
54 *(Wi=Wi+0.001)
55 - if Wi <= Wentmax then goto Loop
56 *(Wj=Wj+0.01)
57 - if Wj <= Wenthmax then goto MainLoop
58 + End: {jump Wlin,Wlin,1,1}{tempo +1}{end}
59 *
60 *
61 *SHAFT-CURVE.TUT
62 *
63 *tutload shaft-curve
64 / Sucro shaft-curve.tut by Jari Pakkanen (Mar 31 1997)
65 / for determining whether shaft profile fits into the defined area.
66 *(tempo -1){init}
67 - if W1 '<>' ? then goto A

```



```

1 1 SURVO 84C EDITOR Sun Dec 13 19:36:31 1998 D:\COLMCN\ 400 100 G
67 - if W1 '<>' ? then goto A
68 *(line start){d}{erase}{erase}Activating sucro{R}
69 *(erase){erase}/SHAFT-CURVE <data>, <ID1>, <ID2>, <maxent>, <minent>, <enth
70 *>, <accuracy>{R}
71 *(erase){erase)determines whether shaft profile fits into the defined {}
72 *area. {R}
73 *(erase){erase}ID1 is the lower limit of the shaft ID, ID2 the upper. {}
74 *maxent and {R}
75 *(erase){erase}minent are the maximum and minimum entases in m, enth g
76 *ives the {R}
77 *(erase){erase}proportional height of the maximum entasis and accuracy
78 * in m defines {R}
79 *(erase){erase}the width of the area (plus-minus at the top and bottom
80 *) . {R}
81 *(goto End)
82 / def Wdata=W1 Wid1=W2 Wid2=W3 Wmaxent=W4 Wminent=W5 Wmaxenth=W6
83 / def Waccu=W7 Wcold1=W8 Wcoldu=W9 Wcolh=W10 Whelp1=W11 Wxtop=W12
84 / def Wm=W13 Whord=W14 Wverd=W15 Wxent=W16 Wlin=W17 Wenth=W18 Wal=W19
85 / def Wb1=W20 Wc1=W21 Wlin2=W22 Wlin3=W23 Wa2=W24 Wb2=W25 Wc2=W26
86 / def Wc2=W27 Wid=W28 Wx=W29 Wy=W30 Wok=W31 Wy1=W32 Wy2=W33
87 + A: {R}
88 *SCRATCH /{act}{home} . {copy} {R}
89 *(R)
90 *(save cursor Wlin, Whelp1) {Wid=Wid1}
91 + Loop: {jump Wlin, Wlin, 1, 1} {erase} IND=Nro, {print Wid} {R}
92 *MASK=--AA--AA--AA--AA--AA--AA----- {R}
93 *FILE LOAD {print Wdata} {act} {R}
94 *(d2) {save cursor Wlin2, Whelp1} {line end} {l} {save word Wcolh} {l8}
95 *(save word Wxtop)
96 /
97 / Determining the coordinates of maximum entasis:
98 / 1. Slope Wm of the straight line from bottom of the column to the top:
99 *(Wm=Wcolh/Wxtop)
100 /
101 / 2. Horizontal distance from maxent-point to straight line:
102 *(Whelp1=Wm*Wm) {Whelp1=1/Whelp1} {Whelp1=Whelp1+1}
103 *(Whord=Wmaxent/Whelp1)
104 /
105 / 3. Vertical distance from maxent-point to straight line:
106 *(Whelp1=1/Wm) {Wverd=Whelp1*Whord}
107 /
108 / 4. X-coordinate of the maxent-point:
109 *(Wenth=Wmaxenth*Wcolh) {Whelp1=Wenth-Wverd} {Whelp1=Whelp1/Wm}
110 *(Wxent=Whelp1-Whord)
111 /
112 / Calling LSQMAT.EXE:
113 *(R)
114 *(line start) . {copy} {R}
115 *(R)
116 *(save cursor Wlin3, Whelp1) @SCRATCH /{act}{home} DATA SHAFT: {R}
117 * -(write Waccu) 0 {R}
118 * -(write Waccu) 0 {R}
119 * {write Wxent} {write Wenth} {R}
120 * {Whelp1=Wxtop-Waccu} {write Whelp1} {write Wcolh} {R}
121 * {write Whelp1} {write Wcolh} END {R}
122 *(d) LSQMAT SHAFT, 2, CUR+1 {act} {R}
123 *(d12) MAT SAVE A {act} {R}
124 *MAT SAVE B {act} {R}
125 *MAT SOLVE X FROM A*X=B {act} {R}
126 *MAT LOAD X, CUR+1 {act} {R}
127 *(d3) {next word} {save word Wal} {R}
128 *(next word) {save word Wb1} {R}
129 *(next word) {save word Wc1}
130 /
131 / Determining the coordinates of minimum entasis:
132 / 2. Horizontal distance from minent-point to straight line:
133 *(Whelp1=Wm*Wm) {Whelp1=1/Whelp1} {Whelp1=Whelp1+1}
134 *(Whord=Wminent/Whelp1)
135 /
136 / 3. Vertical distance from minent-point to straight line:
137 *(Whelp1=1/Wm) {Wverd=Whelp1*Whord}
138 /
139 / 4. X-coordinate of the minent-point:

```

```

1 1 SURVO 84C EDITOR Sun Dec 13 19:37:30 1998 D:\COLMON\ 400 100 G
140 *[Wenth=Wmaxenth*Wcolh]{Whelp1=Wenth-Wvard}{Whelp1=Whelp1/Wm}
141 *[Wxent=Whelp1-Whord]
142 /
143 / Calling LSQMAT.EXE:
144 *(jump Wlin3,Wlin3,1,1)@SCRATCH /(act){home}DATA SHAFT:{R}
145 * {write Waccu} 0{R}
146 * {write Waccu} 0{R}
147 * {write Wxent} {write Wenth}{R}
148 * {Whelp1=Wxent+Waccu}{write Whelp1} {write Wcolh}{R}
149 * {write Whelp1} {write Wcolh} END{R}
150 *[d]LSQMAT SHAFT,2,CUR+1{act}{R}
151 *(d12)MAT SAVE A{act}{R}
152 *MAT SAVE B{act}{R}
153 *MAT SOLVE X FROM A*X=B{act}{R}
154 *MAT LOAD X,CUR+1{act}{R}
155 *[d3]{next word}{save word Wa2}{R}
156 *{next word}{save word Wb2}{R}
157 *{next word}{save word Wc2}{R}
158 *. {copy}{R}
159 *{R}
160 *(Wok=0)
161 + Data: {jump Wlin2,Wlin2,1,1}{next word}{save word Wx}{next word}
162 *{save word Wy}{home}{dell4}
163 - if Wx '=' Wxent then goto Check
164 *(pre){d}{pre}{d}({write Wal})+({write Wb1})+({write Wx})+({write Wc1})+
165 *{write Wx}^2={act}{save line Wyl}{home}{erase}({write Wa2})+{
166 *{write Wb2})+({write Wx})+({write Wc2})+({write Wx}^2={act}
167 *{save line Wy2}{home}{erase}
168 - if Wy > Wyl then goto Copy
169 - if Wy < Wyl then goto Copy
170 *(goto Data)
171 + Check: {pre}{d}{pre}{d}({write Wal})+({write Wb1})+({write Wx})+
172 *{write Wc1})+({write Wx}^2={act}{save line Wyl}{home}{erase}({
173 *{write Wa2})+({write Wb2})+({write Wx})+({write Wc2})+({write Wx}^2=
174 *{act}{save line Wy2}{home}{erase}
175 - if Wy > Wyl then goto Copy
176 - if Wy < Wyl then goto Copy
177 *(Wok=1)
178 + Copy: FILE COPY APU1, {print Wdata}{R}
179 *MATCH=Hro{R}
180 *DATA APU1{R}
181 *Nro OK a1 b1 c1 a2 b2 c2{R}
182 *{write Wid} {write Wok} {write Wal} {write Wb1} {write Wc1} {}
183 *{write Wa2} {write Wb2} {write Wc2}{R}
184 *[u5]{act}{Wid=Wid+1}
185 - if Wid > Wid2 then goto Jump
186 *(goto Loop)
187 + Jump: {jump Wlin,Wlin,1,1}{u2}
188 + End: {tempo +1}{end}
189 *
190 *
191 *!LSQMAT.EXE
192 *
193 *loadp c:\c6\!lsqmat.c
194 /* !LSQMAT.C 29.5.1995/Jari Pakkanen */
195 *
196 *#include <stdio.h>
197 *#include <stdlib.h>
198 *#include <conio.h>
199 *#include <malloc.h>
200 *#include <math.h>
201 *#include "survo.h"
202 *#include "survoext.h"
203 *#include "survodat.h"
204 *
205 *#define MAX 50 /* Maximum number of coordinates */
206 *#define DEG 4 /* Max size of matrix (for 3rd degree function) */
207 *
208 *SURVO_DATA d;
209 *
210 *double XC[MAX]; /* X coordinate data */
211 *double YC[MAX]; /* Y coordinate data */

```

```

1 1 SURVO 84C EDITOR Sun Dec 13 19:38:12 1998 D:\COLMON\ 400 100 G
212 *double MA[DEG][DEG]; /* Matrix A */
213 *double MB[DEG]; /* Matrix B */
214 *double SumX; /* Sum of X's */
215 *double SumX2; /* Sum of X's^2 */
216 *double SumX3; /* Sum of X's^3 */
217 *double SumX4; /* Sum of X's^4 */
218 *double SumX5; /* Sum of X's^5 */
219 *double SumX6; /* Sum of X's^6 */
220 *double SumY; /* Sum of Y's */
221 *double SumXY; /* Sum of X*Y's */
222 *double SumX2Y; /* Sum of X^2*Y's */
223 *double SumX3Y; /* Sum of X^3*Y's */
224 *int i, j, degree, results_line;
225 *char line[LLENGTH];
226 *char elem[32];
227 *
228 *main(argc, argv)
229 *int argc; char *argv[];
230 * {
231 * if (argc==1) return;
232 * s_init(argv[1]);
233 * if (g<3)
234 * {
235 * sur_print("\nUsage: LSQMAT <data>,<degree>,<output_line>");
236 * WAIT; return;
237 * }
238 * results_line=0;
239 * if (g>3)
240 * {
241 * results_line=edline2(word[3],1,1);
242 * if (results_line==0) return;
243 * }
244 * i=data_open(word[1],&d); if (i<0) return;
245 * i=mask(&d); if (i<0) return;
246 * j=0;
247 * for (i=0; i<d.n; i+=2)
248 * {
249 * data_load(&d,d.ll,i,&XC[j]);
250 * data_load(&d,d.ll,i+1,&YC[j]);
251 * ++j;
252 * }
253 *
254 * /* CALCULATING THE LEAST-SQUARE MATRICES */
255 *
256 * /* 2nd and 3rd degree functions */
257 *
258 * SumX=0; SumX2=0; SumX3=0; SumX4=0; SumX5=0; SumX6=0;
259 * SumY=0; SumXY=0; SumX2Y=0; SumX3Y=0;
260 * for (i=0; i<=d.n; ++i)
261 * {
262 * SumX=SumX+XC[i];
263 * SumX2=SumX2+XC[i]*XC[i];
264 * SumX3=SumX3+XC[i]*XC[i]*XC[i];
265 * SumX4=SumX4+XC[i]*XC[i]*XC[i]*XC[i];
266 * SumY=SumY+YC[i];
267 * SumXY=SumXY+XC[i]*YC[i];
268 * SumX2Y=SumX2Y+XC[i]*XC[i]*YC[i];
269 * }
270 * degree=atoi(word[2]);
271 * if (degree==3) /* 3rd degree function */
272 * for (i=0; i<=d.n; ++i)
273 * {
274 * SumX5=SumX5+XC[i]*XC[i]*XC[i]*XC[i]*XC[i];
275 * SumX6=SumX6+XC[i]*XC[i]*XC[i]*XC[i]*XC[i]*XC[i];
276 * SumX3Y=SumX3Y+XC[i]*XC[i]*XC[i]*YC[i];
277 * }
278 * MA[0][0]=d.n/2;
279 * MA[0][1]=SumX; MA[1][0]=SumX;
280 * MA[0][2]=SumX2; MA[1][1]=SumX2; MA[2][0]=SumX2;
281 * MA[1][2]=SumX3; MA[2][1]=SumX3;
282 * MA[2][2]=SumX4;
283 * MB[0]=SumY;

```

```

1 1 SURVO 84C EDITOR Sun Dec 13 19:39:16 1998 D:\COLMON\ 400 100 G
284 * MB[1]=SumXY;
285 * MB[2]=SumX2Y;
286 * if (degree==3) /* 3rd degree function */
287 * {
288 * MA[0][3]=SumX3; MA[3][0]=SumX3;
289 * MA[1][3]=SumX4; MA[3][1]=SumX4;
290 * MA[2][3]=SumX5; MA[3][2]=SumX5;
291 * MA[3][3]=SumX6;
292 * MB[3]=SumX3Y;
293 * }
294 * data_close(&d);
295 *
296 * /* OUTPUT OF MATRICES TO EDIT FIELD */
297 *
298 * output_open(&out);
299 * strcpy(line,"MATRIX A");
300 * print_line(line);
301 * if (degree==2)
302 * strcpy(line,"/// 0 1 2");
303 * else
304 * strcpy(line,"/// 0 1 2 3");
305 * print_line(line);
306 * if (degree==2)
307 * for (i=0; i<=2; ++i)
308 * {
309 * sprintf(line,"%d ",i);
310 * for (j=0; j<=2; ++j)
311 * {
312 * fnconv(MA[i][j],accuracy+6,elem);
313 * strcat(line,elem,accuracy+6);
314 * }
315 * print_line(line);
316 * }
317 * else
318 * for (i=0; i<=3; ++i)
319 * {
320 * sprintf(line,"%d ",i);
321 * for (j=0; j<=3; ++j)
322 * {
323 * fnconv(MA[i][j],accuracy+6,elem);
324 * strcat(line,elem,accuracy+6);
325 * }
326 * print_line(line);
327 * }
328 * strcpy(line," ");
329 * print_line(line);
330 * strcpy(line,"MATRIX B");
331 * print_line(line);
332 * strcpy(line,"/// 0");
333 * print_line(line);
334 * for (i=0; i<=2; ++i)
335 * {
336 * sprintf(line,"%d ",i);
337 * fnconv(MB[i],accuracy+6,elem);
338 * strcat(line,elem,accuracy+6);
339 * print_line(line);
340 * }
341 * if (degree==3) /* 3rd degree function */
342 * {
343 * strcpy(line,"3 ");
344 * fnconv(MB[3],accuracy+6,elem);
345 * strcat(line,elem,accuracy+6);
346 * print_line(line);
347 * }
348 * strcpy(line," ");
349 * print_line(line);
350 * output_close(&out);
351 * }
352 *
353 * print_line(line)
354 * char *line;
355 * {

```

E30 *The Temple of Athena Alea at Tegea*

```
1 1 SURVO 84C EDITOR Sun Dec 13 19:40:49 1998 D:\COLMCN\ 400 100 C
356 * output_line(line,eout,results_line);
357 * if (results_line) ++results_line;
358 * }
359 *
360 *
361 *EXAMPLE:
362 *TEGEADR2.SVO, MaxEnt=0.009-0.013; EntH=0.40-0.60
363 *
364 */SHAFT-MAXENT tegeadr2,1,1678,0.009,0.013,0.40,0.60,0.0015
365 *
```

Index

- abacus, *see* column: capital
 Alea 4
 Aleus 4
 anathrosis 24, 31, 83
 annulets, *see* column: capital
 architrave, *see* entablature
 Argive Heraion
 second temple of Hera 35,
 73 (+ n. 51), D1–2
 arris, *see* column
 Athens
 Parthenon 5, 18, 38 n. 8, 39
 (+ nn. 13, 15), 46
 Stoa of Attalos 18
 axial spacing 7 n. 37
 Bassai
 temple of Apollo 26 n. 49, 35,
 38 n. 8, 39 n. 11, 73, D1–2
 bootstrap-*t* method, *see* statistics
 capital, *see* column
 cella 1, 4–9 (+ n. 19), 12, 38, 62 n. 32, 83
 column
 arris 5 n. 19, 14, 18, 23, 83
 repair 28–30
 capital 4, 23–24, 26–27, 31–40,
 B1–6
 abacus 26–27, 31, 34–35, 38–
 39, 46, 83
 annulets 31, 83
 echinus 31, 34–35, 38, 83
 proportions 34–35, 38–39
 trachelion, 34, 83
 corner c. 23–24
 drum 4, 11–30, 46, 49–63, 68, 83,
 A1–61
 entasis 8, 14–15, 27, 62–73, 83,
 E2–3, E25–30
 design 68–72
 fluting 14, 18, 23, 28, 58
 porch c. 9, 12, 27–28
 shaft height of 14, 49–62
 drum combinations 2–3, 49–
 50, 62, E2, E8–24
 vertical shaft 24–26 (+ n. 49)
 computer programs 2, 54–56 (+ n. 15), 62–
 63, E1–30
 computer simulation 54–56, E2, E8–24
 confidence interval, *see* statistics
 conic sections 68–69
 Corinthian order 1, 5, 7
 Delos
 temple of the Athenians 29 n. 59
 Delphi
 fourth cent. Temple of Apollo 35, 73,
 D1–2
 fourth cent. Temple of Athena 35, 73,
 D1–2
 temple of Athena Pronaia 29 n. 59
 tholos 5 n. 19, 35, 73, D1–2
 treasury of Kyrene 73
 Didyma
 temple of Apollo 69 n. 44
 Dolianà 8 (+ n. 45)
 Doric order 5 (+ n. 19), 12, 73
 dowel 12 (+ n. 9), 18, 24, 57–58, 83
 echinus, *see* column capital
 empolion 12 (+ n. 9), 18, 24, 57–58, 83
 entablature 9, 83, C1–C5
 architrave 31, 45–46, 83, C1–C5
 curvature 27, 39, 45–47
 frieze 4, 45–46, 83, C1–C5
 triglyph 46, 83
 entasis, *see* column
 Epidauros
 temple of Asklepios 35, D1–2
 tholos 26 n. 49, 35, 73, D1–2
 euthynteria 3, 7 (+ n. 37), 25, 83
 foot units 8, 50, 67–68
 foundations 83
 curvature 25 (+ n. 46), 27, 41–43
 frieze, *see* entablature
 Ionic order 5 (+ n. 19), 9
 krepidoma 27, 46, 83
 Labraunda
 temple of Zeus 54
 marble quarries 8 n. 45
 measurement errors 2 (+ n. 7), 12 (+ n. 6),
 22 (+ n. 24), 38 n. 8, 62–63, A8
 Megalopolis
 Thersilion 35, D1–2
 Minerva Alea 4
 Monte Carlo methods, *see* statistics
 Nemea
 temple of Zeus 7, 14, 26 n. 49, 35,
 50, 58 n. 27, 73, D1–2
 Olympia
 Metroon 35, 39 n. 10, D1–2
 opisthodomos 12, 27, 83
 paradeigma, 38 n. 7
 Pausanias 5

- pedimental sculptures 8
- Piali 4
- podium 5 (+ n. 19), 9
- pronaos 12, 27
- proportions 9, 23, 34–35, 38–39, 72–79
- ramp 8, 20
- refinements 25 n. 47, 38 n. 8, 41–47
- shaft, *see* column
- Skopas of Paros 4, 8, 68–69
- statistics
 - bootstrap-*t* method 53–55 (+ nn. 13–15)
 - confidence intervals
 - classical 52 (+ n. 8), 56
 - bootstrap-*t* 53–55, 59–62, 73 n. 51, E1, E4–5
 - Monte Carlo methods 54–56, E1, E6–7
 - normal distribution 52
 - probability of matching drums 57
 - random samples 52, 55–56, E2, E8–9
- Stratos
 - temple of Zeus 8, 35, 73, D1–2
- stylobate 25, 41, 43, 83
- Tegea
 - Archaic temple 3 (+ n. 9), 6–9
 - Byzantine buildings 4, 8
 - Classical temple 3, 8–10
 - architrave 4, 31, 45
 - axial spacing 7 n. 37
 - capitals 4, 23–24, 26–27, 31–40, B1–B6
- Tegea, Classical temple (continued)
 - cella 1, 4–9 (+ n. 19), 38, 62 n. 32
 - podium 5 (+ n. 19), 9
 - column drums 4, 11–30, 46, 49–63, 68, A1–61
 - fluting 14, 18, 23, 28, 58
 - Corinthian order 1, 5, 7
 - date 9
 - description of 8–10
 - entablature 9, 27, 39, 45–47, C1–C5
 - entasis 8, 14–15, 27, 62–73
 - euthynteria 3, 7
 - foundations 25 (+ n. 46), 27, 41–43
 - frieze 4
 - Ionic order 5 (+ n. 19), 9
 - pedimental sculptures 8
 - ramp 8, 20
 - shaft diameters 22–23, 27
 - shaft height 49–62
 - stylobate 25, 41, 43
 - vertical shaft 24–26
 - excavations 3, 6–7, 9, 11–12, 39
 - Geometric buildings 6–7
 - stadium 4
- toichobate 5 n. 19
- trachelion, *see* column: capital
- triglyph, *see* entablature: frieze
- Vitruvius 41

