

A CHEMICAL AND BIOLOGICAL STUDY OF  
ANTIBIOTIC RESISTANCE IN BACTERIA

A thesis presented for the degree of  
Doctor of Philosophy in the Faculty  
of Science of the University of London

by

Prudence Mary Wallis

October 1980

Bedford College, London

ProQuest Number: 10098423

All rights reserved

INFORMATION TO ALL USERS

The quality of this reproduction is dependent upon the quality of the copy submitted.

In the unlikely event that the author did not send a complete manuscript and there are missing pages, these will be noted. Also, if material had to be removed a note will indicate the deletion.

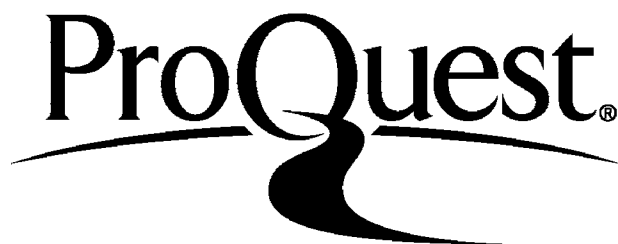

ProQuest 10098423

Published by ProQuest LLC(2016). Copyright of the Dissertation is held by the Author.

All rights reserved.

This work is protected against unauthorized copying under Title 17, United States Code  
Microform Edition © ProQuest LLC.

ProQuest LLC  
789 East Eisenhower Parkway  
P.O. Box 1346  
Ann Arbor, MI 48106-1346

This thesis comprises a report of full-time research undertaken by the author in the Physical Chemistry Laboratories of Bedford College, University of London, from October 1974 to October 1977.

P. M. Wallis.  
30th October 1980.

	<u>Page</u>
<u>CONTENTS</u>	
<u>ABSTRACT</u>	6
<u>ACKNOWLEDGEMENTS</u>	7
<u>SUMMARY</u>	8
<u>CHAPTER 1</u>	13
<u>INTRODUCTION</u>	
1.1. Classification of Bacteria	14
1.2. Bacterial Anatomy	20
1.3. Composition of the Bacterial Cell Wall	24
1.4. The Structure of the Gram-negative Cell Envelope	33
1.5. Antibiotics	41
1.6. Antibiotic Resistance	48
1.7. Metal Ion Resistance	54
1.8. Electrophoresis	55
1.9. Particulate Microelectrophoresis	58
1.10. Application of Microelectrophoresis to the Study of the Bacterial Cell Surface	60
1.11. Objects of the Present Investigation	64
<u>CHAPTER 2</u>	66
<u>EXPERIMENTAL TECHNIQUES</u>	
2.1. Microelectrophoresis Techniques	67
2.2. Bacteriological Techniques	79
2.3. Chemical Techniques	95
<u>CHAPTER 3</u>	100
<u>THE SURFACE AND BIOLOGICAL PROPERTIES OF CELLS OF</u>	
<u>P.AERUGINOSA</u>	
3.1. MIC of Gentamicin for <u>P. aeruginosa</u> Strains	101
3.2. The Effect of Growth Temperature and Nature of the Growth Medium on the pH-Mobility Curves of Cells of <u>P. aeruginosa</u>	105
3.3. The Effect of Growth Temperature and Nature of the Growth Medium on the Surface Lipid of Cells of <u>P. aeruginosa</u>	115
3.4. Summary	118

CHAPTER 4

119

THE SURFACE AND BIOLOGICAL PROPERTIES OF CELLS OFP. AERUGINOSA AFTER REPEATED SUBCULTUREON GENTAMICIN-FREE MEDIUM

- |      |                                                                                                                             |     |
|------|-----------------------------------------------------------------------------------------------------------------------------|-----|
| 4.1. | The Effect of Growth Temperature and Nature of the Growth Medium on the MIC of Cells of <u>P. aeruginosa</u>                | 120 |
| 4.2. | The Effect of Growth Temperature and Nature of the Growth Medium on the pH-Mobility Curves of Cells of <u>P. aeruginosa</u> | 124 |
| 4.3. | The Effect of Growth Temperature and Nature of the Growth Medium on the Surface Lipid of Cells of <u>P. aeruginosa</u>      | 131 |
| 4.4. | Summary                                                                                                                     | 134 |

CHAPTER 5

135

THE SURFACE AND BIOLOGICAL PROPERTIES OF R - FACTORSTRAINS OF P. AERUGINOSA

- |      |                                                                                                                    |     |
|------|--------------------------------------------------------------------------------------------------------------------|-----|
| 5.1. | The Effect of Growth Temperature and Nature of the Growth Medium Before Repeated Subculture                        | 136 |
| 5.2. | The Effect of Growth Temperature and Nature of the Growth Medium after Repeated Subculture on Gentamicin-free Agar | 142 |
| 5.3. | The Attempted Transfer of R-factors                                                                                | 147 |
| 5.4. | Summary                                                                                                            | 149 |

CHAPTER 6

151

CHEMICAL ANALYSIS OF CELLS OF P. AERUGINOSA

- |      |                                                                                     |     |
|------|-------------------------------------------------------------------------------------|-----|
| 6.1. | Analysis of the Protein and Polysaccharide Content of Cells of <u>P. aeruginosa</u> | 152 |
| 6.2. | Divalent Metal Ion Content of Cells of <u>P. aeruginosa</u>                         | 153 |
| 6.3. | Summary                                                                             | 155 |

CHAPTER 7

157

THE EFFECT OF ANTIBACTERIAL AGENTS ON THE CELLSURFACE OF P. AERUGINOSA

- |      |                                                                                                     |     |
|------|-----------------------------------------------------------------------------------------------------|-----|
| 7.1. | EDTA Lysis of Cells of <u>P. aeruginosa</u>                                                         | 158 |
| 7.2. | The Effect of Subinhibitory Concentrations of EDTA on the Mobility of Cells of <u>P. aeruginosa</u> | 159 |
| 7.3. | The Effect of Gentamicin in the Growth Media on the Mobility of Cells of <u>P. aeruginosa</u>       | 161 |
| 7.4. | Summary                                                                                             | 165 |

CHAPTER 8

166

THE SURFACE AND BIOLOGICAL PROPERTIES OF STAPH. AUREUSSTRAINS OF HUMAN AND ANIMAL ORIGIN

8.1.	Phage-typing of <u>Staph. aureus</u> Animal Strains	168
8.2.	The Antibiotic Resistance Properties of Strains of <u>Staph. aureus</u> of Human and Animal Origin	168
8.3.	Detection of the Penicillinase Enzyme	170
8.4.	The Metal Ion Resistance Properties of Strains of <u>Staph. aureus</u> of Animal and Human Origin	173
8.5.	pH-mobility Curves of Strains of <u>Staph. aureus</u> of Animal and Human Origin	173
8.6.	The Effect of Periodate Treatment of Cells of Animal Strains of <u>Staph. aureus</u> on their Surface Properties	177
8.7.	The Divalent Metal Ion Content of Methicillin-Sensitive and-Resistant Strains of <u>Staph. aureus</u> Grown on Agar	182
8.8.	Summary	184

CHAPTER 9

186

DISCUSSIONBIBLIOGRAPHY

231

ABSTRACT

Particulate microelectrophoresis was used to study changes in the surface properties of strains of Pseudomonas aeruginosa and Staphylococcus aureus with respect to changes of growth temperature and growth media which could be related to antibiotic resistance.

Gentamicin-sensitive and intrinsically resistant strains of P. aeruginosa exhibited characteristic, but differently shaped pH-mobility curves; the shape was correlated with surface lipid. The surface properties and MIC values of cells grown at 37°C were not significantly affected by growth at 25°C. Cells of some resistant strains grown at 43°C became gentamicin-sensitive, surface lipid was lost and the shape of the pH-mobility curve altered. Surface lipid was related to intrinsic gentamicin resistance; surface lipid variations were independent of the growth media.

Repeated subculture of P. aeruginosa in the absence of the antibiotic affected the R-factor strains only; resistance was lost after repeated subculture at 37 and 43°C. Cells of strain PL11 also lost both R-factor and intrinsic resistance mechanisms.

When cells were grown on agar containing large amounts of divalent cations the mobility values were lower and the MIC values greater. These changes are attributed to the presence of a metal ion induced resistance barrier, due to association of calcium at the cell surface and to increased polysaccharide production. This barrier prevented the initial accumulation of gentamicin at the cell surface. Intrinsic gentamicin resistance is not due to the inability of gentamicin to bind to the cell surface. The uptake of calcium or gentamicin at the cell surface appeared to be a complex growth effect. Changes in cellular calcium could not be correlated with changes in the antibiotic resistance or surface properties of Staph. aureus.

There was no correlation between the surface and biological properties of animal strains of Staph. aureus or between divalent cation content and methicillin resistance of human strains.

ACKNOWLEDGEMENTS

I would like to express my sincere thanks to Professor A.M. James M.A., D.Phil., D.Sc. Oxon., C.Chem., F.R.S.C. for his constant supervision and encouragement, which has made this work most enjoyable.

I am indebted to the Science Research Council for financial support, which has made this work possible.

Thanks are also due to the academic and technical staff of Bedford College and my research colleagues for their help and co-operation, and to Miss M.A. Skinner for typing the manuscript.

Finally I would like to thank my husband Peter Wythe for his support and encouragement throughout my period of research.



### SUMMARY

The surface of a bacterial cell is often the first and final site of attack by an antibacterial agent. An intrinsic resistance mechanism, or the presence of antibiotic degrading enzymes, can prevent the antibiotic from reaching its site of action. Changes in the cell surface properties which correlate with changes in antibiotic resistance patterns can provide important information on the resistance mechanisms of a cell.

The surface properties of gentamicin-resistant and -sensitive cells of Pseudomonas aeruginosa and methicillin-resistant and -sensitive cells of Staphylococcus aureus have been correlated with antibiotic resistance or sensitivity. The present work was undertaken to study changes in the surface properties (using particulate microelectrophoresis) and the antibiotic resistance patterns of P. aeruginosa and animal and human strains of Staph. aureus with respect to changes in growth temperature and growth media.

Cells of P. aeruginosa were also studied after repeated subculture in the absence of gentamicin. Other techniques used include atomic absorption spectrophotometry for analysis of the cellular divalent metal ion content, the disc diffusion technique for determination of the antibiotic and metal ion resistance patterns of Staph. aureus and estimation of MIC values and chemical analysis of cells of P. aeruginosa.

The findings of the study on cells of P. aeruginosa at 37°C confirmed those of Pechey and James (1974) Pechey et al., (1974) and Chapman (1976). Characteristic but differently shaped pH-mobility curves were obtained for gentamicin-resistant and -sensitive strains. Strains possessing resistance due only to the presence of R-factors exhibited surface properties similar to gentamicin-sensitive cells.

Gentamicin-sensitive cells of P. aeruginosa exhibited wave-(SN) shaped pH-mobility curves which correlated with low MIC values ( $<12 \mu\text{g cm}^{-3}$ ) and low surface lipid content (S-value $<10$ ), irrespective of the growth temperature, growth medium or repeated subculture. The SN shape can be described in terms of a maximum negative mobility value in the pH range of 5-6, followed by a minimum mobility value between pH 8-9; the difference between these mobility values expressed as a percentage of the maximum mobility was termed the W-value. The SN shape was classified as significant if the W-value was greater than 10. The wave-shaped pH-mobility curve may be attributed to the reorientation or rearrangement of the surface molecules.

Gentamicin-resistant cells of P. aeruginosa with an intrinsic resistance mechanism exhibited R-shaped pH-mobility curves, MIC values  $>12 \mu\text{g cm}^{-3}$ , and, in general, significant amounts of surface lipid (S-values  $> 10$ ). An R-shaped curve was characterized by mobility values which became more negative with increase in pH attaining a plateau at about pH 7; a decrease in mobility sometimes occurred at high pH values.

Growth at  $25^{\circ}\text{C}$  had no effect on the surface properties or MIC values of gentamicin-sensitive and-resistant strains. Some strains lost their resistance to gentamicin at  $43^{\circ}\text{C}$ , these changed MIC values were correlated with changes in the shape of the pH-mobility curve and a significant reduction in surface lipid. Thus intrinsic resistance could be linked with the production of surface lipid. Several theories regarding the presence of an intrinsic resistance mechanism in cells of P. aeruginosa have been postulated. Some cells when grown on agar at  $43^{\circ}\text{C}$  had SN-shaped pH-mobility curves, negligible surface lipid, but were gentamicin-resistant. Thus the SN shape of the pH-mobility curve is not always correlated with gentamicin-sensitivity.

The surface properties and MIC values of strains possessing R-factors were affected by repeated subculture in the absence of the antibiotic; these became characteristic of a gentamicin-sensitive strain. The R-factors were lost after repeated subculture at 37 and 43°C, but were not lost at 25°C; since on mating of the donor R-factor strains with a gentamicin-sensitive, rifampicin-resistant acceptor strain transconjugants could only be produced from cells repeatedly subcultured at 25°C. Strain PL11 lost both its R-factor and intrinsic resistance mechanisms after repeated subculture; surface lipid was not detectable. Thus surface lipid would appear to be the cause or result of the intrinsic mechanism of resistance in PL11 suggesting that the enzymes coding for the production of surface lipid are probably located extrachromosomally on a plasmid.

Cells of all strains, irrespective of their temperature of growth, sensitivity to gentamicin or repeated subculture have significantly lower negative mobility values and higher MIC values when grown on agar containing large amounts of divalent cations compared with values for cells grown in broth. The difference in the mobility values of agar and broth-grown cells was expressed in terms of a D-value. A D-value greater than 10 is indicative of a significantly different surface charge. However, variations in surface lipid was not correlated with changes in the growth media. Growth of cells on agar does not result in permanent changes in their surface properties and MIC values; the gentamicin-sensitivity patterns are fully reversed when these cells are regrown in broth.

The divalent metal ion content of cells grown on agar was greater than that of cells grown in broth; this was mainly attributed to greater amounts of calcium. Agar-grown cells contained more polysaccharide, but the protein content was, in general decreased. Treatment with

ethylenediaminetetraacetic acid (EDTA) showed that divalent metal ions, probably calcium, were associated with the surface of resistant and sensitive cells grown on agar. The antagonistic species-specific effect of divalent metal ions against gentamicin in strains of P. aeruginosa is attributed to a metal ion induced resistance barrier which is associated with the presence of divalent metal ions at the cell surface and increased polysaccharide production thus increasing the structural rigidity of the cell envelope. This metal ion induced resistance barrier prevented the initial accumulation of gentamicin at the cell surface probably by blocking or occupying those ionogenic surface groups required for gentamicin binding. This initial primary phase accumulation can occur in both sensitive and resistant strains. Intrinsic resistance to gentamicin did not appear to be due to the inability of gentamicin to bind to the cell surface. When a critical concentration of gentamicin is present in the growth medium gentamicin accumulation can take place at the cell surface, possibly as a result of a concentration-gradient effect, after which the metal ion induced resistance barrier is eventually overcome.

The concentration of gentamicin required to promote secondary phase accumulation is probably different in resistant and sensitive strains and related to the intrinsic resistance of the cell. Once gentamicin has accumulated at the cell surface of sensitive strains it can be transported to the ribosomal site. Cells resistant due to the presence of an intrinsic resistance barrier, which could be related to surface lipid, require a much greater concentration of gentamicin at the cell surface than sensitive strains before secondary phase accumulation can take place. Washing the cells did not remove gentamicin or calcium from the cell surface; thus the association of gentamicin and calcium at the cell surface is a complex process occurring during growth, possibly mediated by enzymes.

Changes in the surface properties of cells of Staph. aureus could not be correlated with the large increase in the cellular calcium content or with changes in antibiotic resistance when cells of methicillin-sensitive and -resistant strains were grown on agar A4, in contrast to gentamicin-resistant and -sensitive strains of P. aeruginosa.

Animal strains of Staph. aureus possessed similar metal ion resistance properties (resistant to magnesium, zinc, copper arsenate, sensitive to cadmium and phenylmercury), however half these strains were antibiotic sensitive, whereas half were resistant to penicillin G due to the presence of penicillinase. Elevated growth temperatures resulted in the loss of penicillin resistance from two poultry strains. This suggests that the genes controlling penicillinase production in these strains are plasmid-borne and loss of resistance is due to the inability of the plasmid to divide into daughter cells. Large amounts of calcium in the growth media affected tetracycline resistance whilst large amounts of inorganic phosphate affected sensitivity to cadmium; both these effects were probably due to extracellular complex formations.

The surface properties of the animal strains of Staph. aureus were found to be complex. The shape of the pH-mobility curves could, in general, be correlated with those of methicillin-sensitive and -resistant strains but not with resistance or sensitivity to other antibiotics, unlike strains of human origin. Variations in the phage-type could not be correlated with changes in surface properties.

Thus animal strains possess phage-types and surface properties which appear too complex to warrant any correlation between these properties, antibiotic resistance, metal ion resistance, or with the properties of cells of methicillin-sensitive and -resistant strains of human origin.

CHAPTER ONE

INTRODUCTION

### 1.1. Classification of Bacteria

The lower orders of life known as microorganisms are divided into the following major groups: algae, protozoa, yeasts, moulds, pleuropneumonia- like organisms (PPLO), bacteria and rickettsia, and viruses. Inclusion in a group is dependent on the possession of distinct characteristics.

Bacteria, or schizomycetes, are classified in Bergey's Manual (1974). This classification differs from previous ones; however, since new classifications are continually being proposed, the above classification is by no means finalised. In this classification certain orders, including Eubacteriales and Pseudomonadales, are no longer recognised. A classification of the bacteria used in this investigation is shown in Table 1.1.

Bacteria are classified by their structural, biochemical, nutritional, physiological and ecological characteristics. For example, characteristics such as cell size and shape, motility, presence or absence of polar or peritrichous flagella, reaction to the Gram stain, growth requirements, types of fermentations which the cultures are capable of carrying out under aerobic or anaerobic conditions, and genetic data are found to be of differentiating use.

The Gram stain, as a preliminary characterisation technique, can classify an organism as Gram-positive, Gram-negative or Gram-variable depending on its ability to retain crystal violet dye after mordanting with iodine solution; Gram-negative organisms are counterstained with fuschin. The Gram stain also reveals general cell morphology and whether or not cells form spores.

Bacteria are defined by the absence of a clearly defined nucleus, they are generally unicellular, but arrangement of units

Table 1.1

A classification of the bacteria used in this investigation

<u>Description</u>	<u>Family</u>	<u>Genus</u>
<u>Gram-positive Cocci</u>		
Aerobic and/or facultatively anaerobic	I Micrococcaceae	Micrococcus Staphylococcus Planococcus
	II Streptococcaceae	
Anaerobic	I Peptococcaceae	
<u>Gram-negative Aerobic Rods and Cocci</u>		
	I Pseudomonadaceae	I Pseudomonas II Xanthomonas III Zoogloea IV Gluconobacter
	II Azotobacteraceae	
	III Rhizobiaceae	
	IV Methyloomonadaceae	
	V Halobacteriaceae	
<u>Gram-negative Facultatively Anaerobic Rods</u>		
	Enterobacteriaceae	12 including Klebsiella Escherichia
	Vibrionaceae	



may be in the formation of chains or irregularly arranged packets e.g. staphylococci. The cells are morphologically simple and multiply by division.

The Micrococcaceae, Gram-positive cocci, are aerobes or facultative anaerobes. The spherical cocci of the family Micrococcaceae are subdivided into genera on the basis of the manner in which they cling together after fission. The genera Micrococci, Staphylococci and Planococci divide irregularly in more than one plane and can exist either in single cells or in clusters resembling bunches of grapes. The genus *Staphylococcus* is separated from the genus *Micrococcus* (Bergey, 1974) by the G and C content of the DNA, cell wall composition and an ability to grow anaerobically, and under these conditions to ferment glucose. The metabolism of the *Staphylococcus* is respiratory and fermentative.

Three species are recognised in the genus *Staphylococcus*: *Staph. aureus*, *Staph. epidermidis* and *Staph. saprophyticus* (Table 1.2). These species are identified by reactions such as the production of coagulase (*Staph. aureus*) and the type of teichoic acid in the cell wall. The walls of *Staph. aureus* possess ribitol teichoic acid, whereas the walls of *Staph. epidermidis* possess glycerol teichoic acid.

*Staph. aureus*, one of the organisms used in this investigation, may be described as a Gram-positive, coagulase-positive coccus, capable of producing lactic acid from glucose under anaerobic conditions. Most strains grow between 6.5 and 46°C (optimum 30-37°C), pH values between 4.2 and 9.3 (optimum pH 7.0-7.5) and in 15% sodium chloride. The colonies are smooth, low-convex, glistening and with an entire edge. Growth on solid medium produces cells with a golden/yellow pigment arranged in grape-like clusters. The production of pigments depends

Table 1.2

A classification of Staphylococcus aureus andPseudomonas aeruginosa

<u>Genus</u>	<u>Sub-generic</u>	<u>Species</u>
Staphylococcus	Coagulase-positive/ RTA*	<u>Staph. aureus</u>
	Coagulase-negative/ GTA**	<u>Staph. epidermidis</u>
	Coagulase-negative/ GTA and RTA	<u>Staph. saprophyticus</u>
Pseudomonas	Fluorescent/ saprophytic	<u>P. aeruginosa</u>
		<u>P. putida</u>
		<u>P. fluorescens</u>
		<u>P. chlororaphis</u>
		<u>P. aureofaciens</u>
	Fluorescent/ phytopathogenic	<u>P. syringae</u>
		<u>P. cichorii</u>
non-fluorescent/ nitrate denitrified	<u>P. stutzeri</u>	
	<u>P. mendocina</u>	
non-fluorescent/ do not denitrify	<u>P. alcaligenes</u>	

\* RTA Ribitol teichoic acid

\*\* GTA Glycerol teichoic acid

on the growth conditions and may be variable within a single strain. Each coccus is 0.8 to 1.0  $\mu\text{m}$  in diameter, non-motile, non-sporing and usually non-capsulate.

Staphylococci are usually found on the skin and mucus membranes of the animal body (including man). Staph. aureus is the most likely pathogen involved in skin and soft tissue infections (boils, carbuncles, abscesses, impetigo) and is often implicated in infections of the nose and throat. It is the cause of mastitis in lactating mothers. The most pathogenic strains of staphylococci generally ferment mannitol, liquefy gelatin and produce enzymes including coagulase, lipolytic enzymes and enzymes which produce zones of  $\beta$ -haemolysis on blood agar. Coagulase may be a virulence factor, by coagulating blood plasma and preventing the natural defensive action of the host body.

The Pseudomonadaceae are Gram-negative aerobic rods and cocci. Members of the genus *Pseudomonas* are common inhabitants of soil, fresh water and marine environments where their activities are important in the mineralization of organic matter. Most species require no growth factors and can develop in mineral media with a single organic compound as sole source of carbon and energy. Members of the genus *Pseudomonas* consist of motile, Gram-negative aerobic rods (straight or curved). The metabolism of the cell is respiratory, never fermentative. *Pseudomonas* is further divided into subgeneric groups according to characteristics such as the ability to fluoresce, type of flagellation, ability to form pigment and biochemical reactions (Stanier et al., 1966).

The Gram-negative organism used in this investigation, Pseudomonas aeruginosa is a member of the fluorescent pseudomonad sub-generic group (Table 1.2) and is distinct from other members of the group in that it shows only monotrichous flagellation and produces two pigments, pyocyanin (a soluble phenazine pigment, blue in neutral or alkaline, red in acid media) and fluorescein (a greenish-yellow pigment). It is the only fluorescent pseudomonad pathogenic to man. The non-spore forming rod of P. aeruginosa has dimensions of 1.5 x 0.5  $\mu\text{m}$  to 3.0 x 0.8  $\mu\text{m}$  and is actively motile as a result of its polar monotrichous flagellum; it is usually non-capsulate. Growth occurs over a wide temperature range under aerobic conditions (5 - 43<sup>o</sup>C); the cells utilize a wide range of energy sources. Cultures have a characteristic odour resembling that of trimethylamine. The colonies are dark-greyish, large, low convex with an irregular spreading edge which is translucent. P. aeruginosa can produce acid oxidatively from glucose. It rapidly liquefies gelatin, and unlike most Gram-negative rods gives a positive oxidase reaction. Studies on the single polar flagellum of P. aeruginosa have shown that it is a thread-like structure (diameter 15 - 20 nm) protruding from the cell surface but continuous with the cell cytoplasm (Murray and Birch-Andersen, 1963). The flagellum consists of 98% flagellin, a protein with a relatively low molecular mass (40,000) containing 14-15 amino acids arranged in a spiral pattern with a periodicity of 25 nm (Lowy and Hanson, 1965). The flagella impart motility to the cell by virtue of their movement and are believed to be the site of H-antigens.

P. aeruginosa is sometimes present on healthy human skin and in small numbers in the intestinal flora of man and animals, and is thus isolated from sewage. As a pathogen it is usually associated with pyogenic cocci or members of the Enterobacteriaceae.

It is often implicated in urinary tract infections and infections due to catheterization and other diagnostic and therapeutic instrumentations. It commonly infects deep wounds and burns and may cause acute purulent meningitis following cranial injury or accidental introduction after lumbar puncture. The infections are usually localised, but in infants and debilitated persons it may invade the blood stream, resulting in fatal generalised infections, especially when the patient is receiving antineoplastic drugs or radiation therapy.

#### 1.2. Bacterial Anatomy

A cross-section of the basic cellular organisation of the Gram-positive and Gram-negative bacterial cell is illustrated in Fig 1.1.

The bacterial cell consists of cytoplasm which is surrounded by a membrane and this is surrounded by a cell wall. In Gram-negative cells the cell membrane and cell wall become integrated, thus they are not clearly defined separate entities and are collectively termed the cell envelope.

The cytoplasm is a slightly viscous colloidal complex of water, amino acids, proteins, fats, carbohydrates and inorganic material. The presence of oils and stored nutrients suspended in the cytoplasm has been demonstrated. The cytoplasm is granular in appearance due to the presence of storage particles and ribosomes, the latter being the cytoplasmic site of protein synthesis. The nuclear material, or nucleoid body, which is present in the cytoplasm is not bound by a nuclear membrane.

The cytoplasmic membrane in Gram-positive cells is non-rigid. It is the site of much enzymic activity and is responsible for the osmotic properties of the cell. The rigid cell wall surrounding the cytoplasmic membrane gives it mechanical support. It appears

FIGURE 1.1

Cross-section of a bacterial cell

GRAM-POSITIVE

GRAM-NEGATIVE

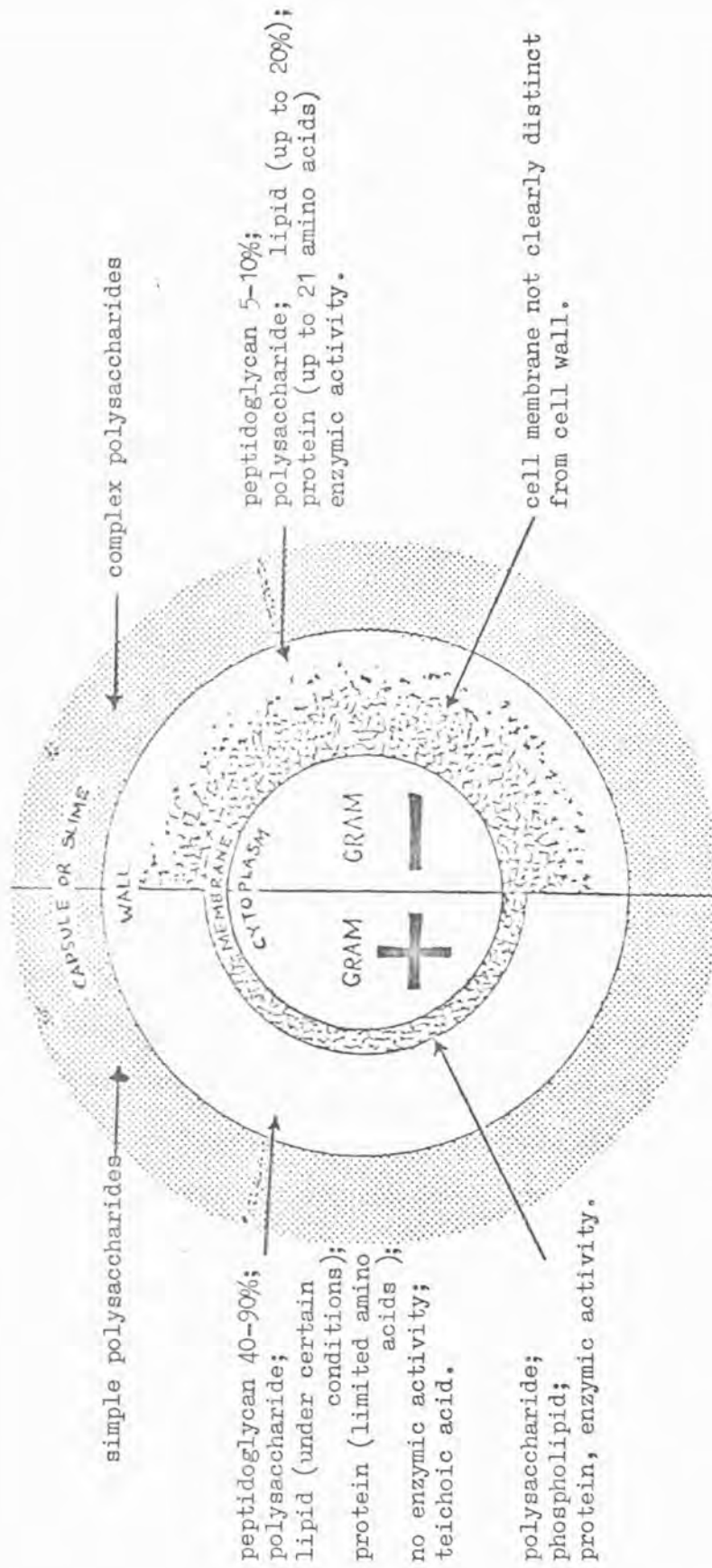

to take no part in the essential metabolism of the cell. The inner part of the cell envelope of the Gram-negative cell is analogous with the Gram-positive cytoplasmic membrane.

In many bacteria a capsule or slime layer surrounds the cell; their production is influenced by the nature of the growth medium and conditions of growth.

The presence of these capsules is often correlated with virulence in pathogenic forms. Wilkinson (1958) classified capsules into three main types:-

- (i) macrocapsules - at least 0.2  $\mu\text{m}$  thick, having a definite external surface
- (ii) microcapsules - less than 0.2  $\mu\text{m}$  thick and usually detected immunologically
- (iii) slime layers - material which accumulates in the medium at the surface and has little anatomical significance.

Capsular material consists of approximately 98% water. It is chemically more complex when derived from Gram-negative organisms than when derived from Gram-positive cells. In certain Gram-negative organisms extracellular polysaccharides often occur as microcapsules in association with lipoprotein. These complexes contain the O-somatic antigens which are important in relation to classification and pathogenicity.

The composition of the slime layers of P. aeruginosa varies quite widely with different strains. However, Bartell et al. (1970) reported that the main constituent was polysaccharide, although a significant amount of protein was present. Eagon (1962) estimated that mannose constituted about 50% of the dry slime material and that appreciable amounts of DNA, RNA, and small quantities of protein were present. Other components of the slime layer include glucose, rhamnose, fucose, galactose, glucosamine,

galactosamine and glucuronic acid (Doggett et al., 1964; Brown et al., 1969). Slime production has been shown to be dependent on various parameters, including temperature, mineral salt and trace element concentration (Palumbo, 1972; Goto, Murakawa and Kuwahara, 1973) and the nature of the carbon source (Brown et al., 1966; 1969). Brown and Foster (1971) examined the resistance of slime producing cultures (glucose grown) to EDTA and polymyxin and concluded that, in vitro, slime does not appear to play a significant role in the resistance of P. aeruginosa. Slime production is relevant in resistance to in vivo body defence mechanisms (Schwarzmann and Boring, 1971; Roe and Jones, 1974).

Some bacteria exhibit surface appendages such as flagella, cilia and fimbriae (or pili). There are several different arrangements of flagella as exemplified by the single (monotrichous) polar flagellum of P. aeruginosa protruding through the cell surface but continuous with the cytoplasm, the polar tufts of Spirillum serpens (multitrichous) and flagella distributed around the surface as in Bacillaceae (peritrichous). Fimbriae are very fine non-motile hair-like structures which confer the properties of haemagglutination, adhesion and antigenicity to the cells. Cilia impart motility, aid removal of waste products as well as supply nutrients to the organisms by moving liquid over the cell surface.

The survival of the bacterial cell is dependent on the mechanical strength of the cell wall and its ability to withstand the physical and chemical effects of various natural and synthetic lytic agents.



### 1.3 Composition of the Bacterial Cell Wall

The principal chemical constituents found in the outer layers of the bacterial cell are peptidoglycan, protein, polysaccharide, lipid and their complexes. In addition teichoic acid contributes significantly to the Gram-positive cell wall. Differences in the outer cell structures of Gram-positive and Gram-negative cells are described as follows:

Gram-positive organisms, such as Staph. aureus have a cell wall with a very high tensile strength, which protects the cells against osmotic explosion should the salt and sugar concentrations of the external environment become very low. The wall is capable of withstanding an osmotic pressure of up to 30 atmospheres. The structure of the cell wall is unified, well defined, and distinct from the cytoplasmic membrane. Little enzymatic activity is present.

The Gram-negative cell is not capable of withstanding such high osmotic pressures (12 atmospheres). The cell envelope provides a permeability barrier between the cytoplasm and the environment. It is responsible for the antigenicity and response to pyocins and bacteriophage. The Gram-negative cell envelope consists of a number of layers of varying physical and chemical composition between which there are no clearly defined boundaries.

The Gram-negative cell envelope, which gives the cells its rigidity and shape, contains a greater range of amino acids (up to 21) (Salton, 1952), whereas the Gram-positive cell wall may contain as few as 3 amino acids. The cell envelope of P. aeruginosa contains

13 amino acids, 4 of which - alanine, glutamic acid, lysine and diaminopimelic acid, are associated with the peptidoglycan layer (Mandelstam, 1962). The amino sugar content of the cell envelope is less than that of the Gram-positive cell wall.

There is a marked difference between the lipid composition of the two wall structures. The amount of lipid in the Gram-positive cell wall is low (<5%) (Salton, 1953) but in the cell envelope of Gram-negative organisms such as P. aeruginosa the presence of lipid assumes an important role. Readily extractable lipid accounts for approximately 16% of the total cell weight and almost half of this is phospholipid (Bobo and Eagon, 1968). Firmly bound lipid accounted for approximately 9% of the cell weight, much of which is incorporated into the lipopolysaccharide layer. The lipid composition of the cell envelope of P. aeruginosa is typical of Gram-negative bacteria, consisting primarily of phosphatidyl ethanolamine and diphosphatidyl glycerol (Clarke et al; 1967 a,b,c; Bobo and Eagon, 1968). Brown (1971) suggested that in general phosphatidyl ethanolamine is the major phospholipid in Gram-negative bacteria, while in Gram-positive bacteria it is phosphatidyl glycerol.

### 1.3.1 Peptidoglycan

In the Gram-positive cell wall peptidoglycan (also known as murein, mucopeptide, glycopeptide, glucosamine peptide) is the major constituent (Salton, 1956; Work, 1957) and makes up 40-90% of the cell wall. Peptidoglycan is the fundamental building block upon which the Gram-positive wall is based and is responsible for cell rigidity, further it confers a considerable amount of stability to the cell. However peptidoglycan contributes

about 10% to the structure of the Gram-negative cell envelope. Shafa and Salton (1960) have presented evidence to suggest that another component is also responsible for the rigidity of the Gram-negative cell envelope; this is probably the lipoprotein isolated by Braun and Rehn (1969). Gram-negative cells bound only by peptidoglycan maintain their shape (Fosberg et al., 1970a) even though other cell layers contribute to cellular rigidity (Carson and Eagon, 1966; Cox and Eagon, 1968).

The peptidoglycan is 2-3 nm thick in the Gram-negative envelope and 20-80 nm in the Gram-positive cell wall. The thicker peptidoglycan layer of the Gram-positive cell wall suggests a three-dimensional arrangement, compared to the thinner layer in the Gram-negative cell envelope indicative of a two-dimensional monolayer (Ghuysen, 1968; Keleman and Rogers, 1971). A random arrangement of cross-linked peptide subunits in the cell envelope results in a loose network in contrast to the high cross-linked structure of the Gram-positive cell wall.

The structure of the peptidoglycan complex was elucidated by Strominger et al. (1959), Mandelstam and Strominger (1961), Rogers and Perkins (1959), Hancock (1960) (Fig 1.2). Analysis of the peptidoglycan isolated from the cell wall of the Gram-positive organism Staph. aureus showed that the main amino acid components are lysine, glycine, glutamic acid and alanine (Mandelstam and Rogers, 1959). Glucosamine and muramic acid, first isolated by Strange and Kent (1959) are also present. The peptidoglycan of Staph. aureus consists of a polysaccharide backbone of alternating  $\beta$ -1, 4 N-acetylglucosamine and N-acetyl muramic acid units with short peptide chains attached to the latter (Fig. 1.3) which, in turn, are linked by pentaglycyl

FIGURE 1.2. The structure of peptidoglycan

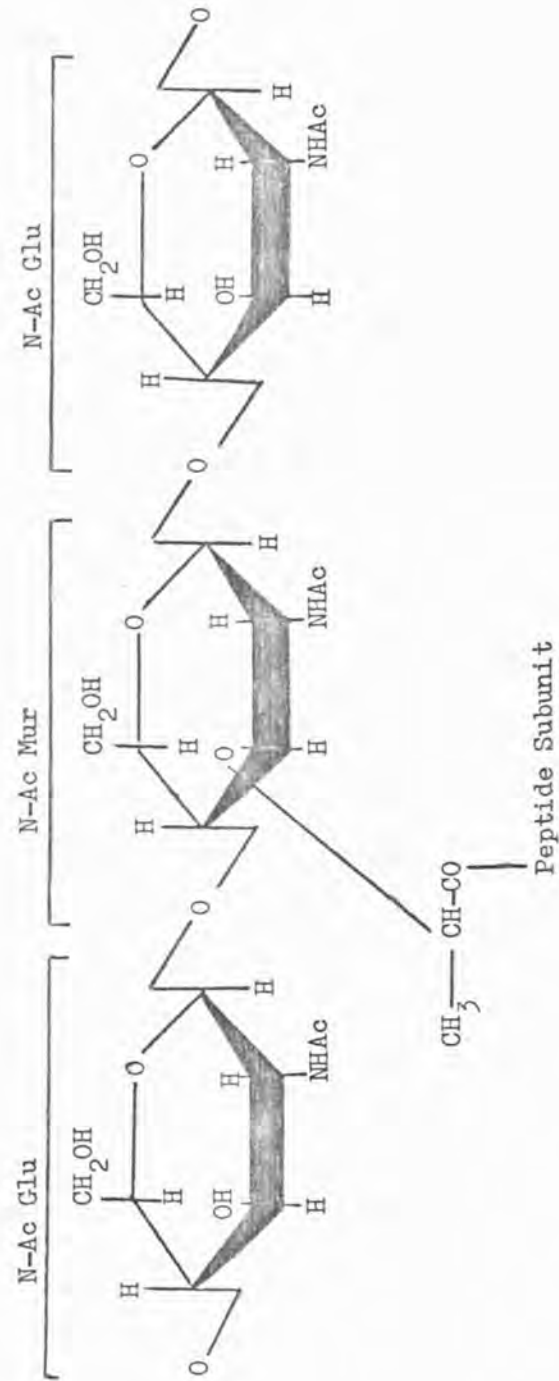

N-Ac Glu = N-acetylglucosamine

N-Ac Mur = N-acetylmuramic acid

FIGURE 1.3 The structure of the cell wall peptidoglycan of *Staph. aureus*

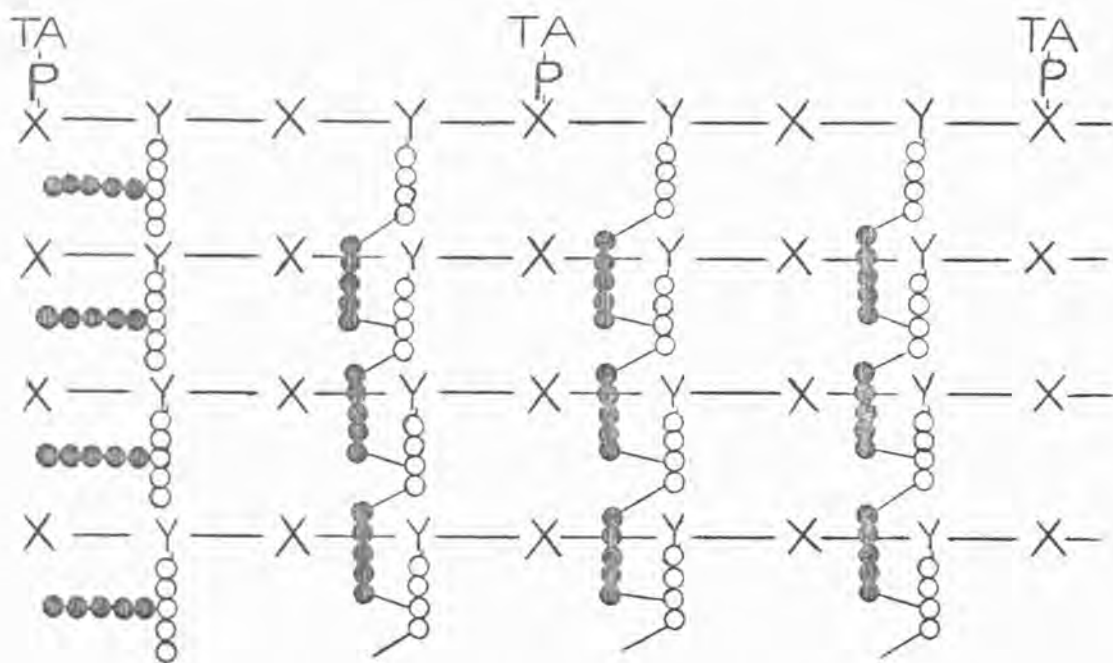

X N-acetylglucosamine

●●●●● pentaglycine cross-link

Y N-acetylmuramic acid

○○○○: amino acid in tetra or pentapeptide \*

TA-P ribitol teichoic acid

\* Sequence of pentapeptide

L-ala, D-glu, L-lys, D-ala, D-ala

cross-bridges. These interpeptide bridges extend from the carboxyl group on the D-alanine residue of the tetrapeptide to the  $\epsilon$ -amino group of lysine - the third amino acid in the tetrapeptide chain. The free carboxyl group of glutamic acid is substituted by an amide. Ghuyssen et al. (1965), Tipper and Strominger (1965), Petit, Muñoz and Ghysen (1966) suggested that every tenth peptide chain terminates with a di-D-alanyl group and that the other nine have only a single terminal D-alanine. Thus the peptidoglycan of Staph. aureus is a very tightly linked structure in that virtually every peptide subunit is cross-linked to another subunit by means of the interpeptide bridge. Studies of three-dimensional molecular models of the peptidoglycan (Rogers, 1970) indicate the possibility of extensive hydrogen bonding which may add to the rigidity of the peptidoglycan.

The 'Park nucleotide' (Park, 1952) discovered in the walls of staphylococci treated with penicillin consists of a uridine pyrophosphate N-acetylamino sugar peptide. The peptide consists of one molecule each of glutamic acid and L-lysine and three molecules of L-alanine (Park and Strominger, 1957). This nucleotide is probably the precursor of the peptidoglycan-polymer complex.

The peptidoglycan of the Gram-negative cell envelope consists of a polysaccharide backbone of alternating  $\beta$ -1, 4 N-acetylglucosamine and N-acetyl muramic acid residues similar to the Gram-positive cell wall. The first Gram-negative peptidoglycan was isolated by Weidel et al. (1960). Attached to the N-acetyl muramic acid molecules are peptide subunits consisting of L-alanine, D-glutamic acid, diaminopimelic acid (or its decarboxylation product L-lysine) and D-alanine. These peptide chains are often linked together by peptide bridges but in the case of Escherichia coli and probably

P. aeruginosa the bridging is via direct bonding from the D-alanine of one subunit to the (D)-asymmetric carbon atom of the meso-diaminopimelic acid of the neighbouring subunit (Fig. 1.4). Braun and Rehn (1969) showed that there remained one lysine residue for every ten repeating units (N-acetylglucosamine, N-acetylmuramic acid, L-alanine, D-glutamic acid, meso diaminopimelic acid, D-alanine) of the peptidoglycan.

### 1.3.2 Teichoic Acid

The cell wall of many Gram-positive bacteria have a high phosphate content. This is attributed to the presence of surface or wall teichoic acid which is attached to the cell wall peptidoglycan. Teichoic acids are found both in the cell wall and cytoplasmic membrane of Gram-positive bacteria, but are not generally found in Gram-negative bacteria. Membrane associated teichoic acids are characterised by their uniformity of structure, whilst wall associated teichoic acids are remarkable for their structural diversity.

The simplest wall teichoic acids are either glycerol or ribitol teichoic acid. These polymers contain only a restricted array of sugar substitutes. Ribitol teichoic acid with  $\alpha$ - and  $\beta$ -N-acetylglucosamine residues (Baddiley et al., 1962) is mainly associated with cell walls of Staph. aureus. (Fig. 1.5).

When grown under favourable conditions cells of Staph. aureus, in common with other Gram-positive organisms, have surface teichoic acid; under unfavourable growth conditions acidic polysaccharides possessing uronic acid residues are present in the cell walls (Hepinstall et al., 1970). It is unlikely that these compounds serve the same purpose as teichoic acid.

FIGURE 1.4 The Gram-negative cell envelope peptidoglycan showing the site of cross-linking between adjacent glycan strands of N-acetylglucosamine and N-acetylmuramic acid

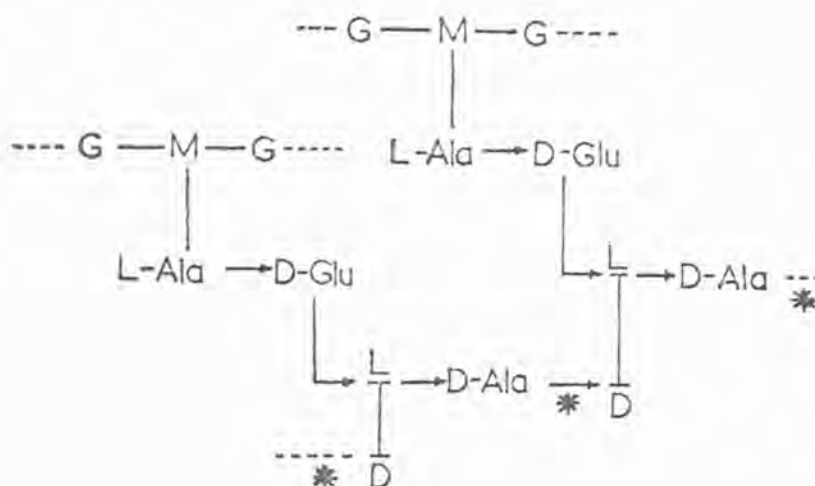

Key

G	N-acetylglucosamine	L-Ala	L-alanine
M	N-acetylmuramic acid	D-Ala	D-alanine
L   D	Meso-diaminopimelic acid, with asymmetric carbon atoms designated L and D	D-Glu	D-glutamic acid
		*	Site of cross-linking



FIGURE 1.5

Structure of cell wall ribitol teichoic acid from Staph. aureus

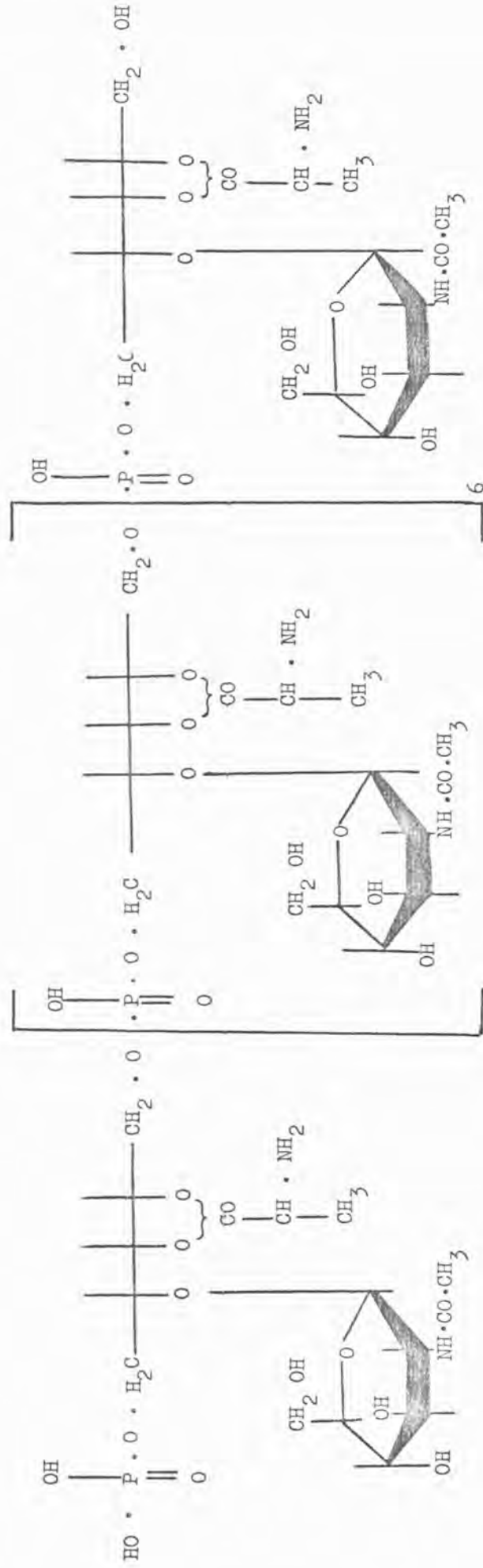

Teichoic acids are associated with serological functions, (Losnegard and Oeding, 1963), receptor sites for bacteriophages (Archibald and Coapes, 1971) and ion transport (Heptinstall et al., 1970). The major function of both wall and membrane teichoic acid could be to maintain a high concentration of divalent metal ions in the region of the membrane.

#### 1.4 The Structure of the Gram-negative Cell Envelope

Pioneering work on the complex structure of the Gram-negative cell envelope was carried out on Esch. coli using thin-section electronmicroscopy by Kellenberger and Ryter (1958); other workers (e.g. Murray, 1962) obtained similar results. From these studies Brown et al. (1962) and Clarke and Lilly (1962) proposed that the cell envelope of most, if not all, Gram-negative bacteria consists of two unit or compound membranes, each with the structure of protein-lipid-lipid-polysaccharide separated by a rigid layer of peptidoglycan. The inner compound membrane was shown to be analogous with the cytoplasmic membrane of other biological membranes (Martin and MacLeod, 1971) and the peptidoglycan and outer compound membrane analogous with the peptidoglycan layer which constitutes almost the entire Gram-positive cell wall. More detailed studies of the Gram-negative cell envelope have been undertaken by De Petris (1967) and Costerton et al. (1974).

##### 1.4.1 Cytoplasmic Membrane

The inner compound membrane of Gram-negative bacteria, analogous to the Gram-positive cytoplasmic membrane, has been studied by a freeze-etching technique. Bayer and Remsen (1970) showed that the membrane cleaved along a median hydrophobic zone and that this zone is traversed by protein studs (DeVoe et al., 1971) which may be involved in substrate transport (Tourtellotte and

Zupnik, 1973). Fox (1972) has proposed that structural membrane proteins are built into the continuous phospholipid bilayer; other proteins may be associated with the inner and outer aspects of the membrane by hydrophobic interactions.

Nakane et al. (1968) showed that binding proteins such as the leucine binding protein of Esch. coli are associated with the cytoplasmic membrane, and certain enzymes such as the adenosine-hydrolysing enzyme of Esch. coli are located at the outer surface of the cytoplasmic membrane (Hochstadt-Ozer, 1972).

The cytoplasmic membrane is the site where the structural components of the cell wall are synthesized and assembled.

#### 1.4.2 Periplasmic Zone

The underlying layer of peptidoglycan is located in the periplasmic space, an electron-transparent layer, located between the outer and cytoplasmic membranes. The periplasmic enzymes, which are believed to be associated with structural components of the cell wall, are distributed throughout the periplasmic zone. Braun and Rehn (1969) isolated a lipoprotein from the periplasmic space containing twelve amino acids covalently bound to the peptidoglycan by a terminal lysine residue. There is evidence that F. aeruginosa contains less bound lipoprotein than in Esch. coli (Meadow, 1975). The passage of drugs across the periplasmic space is essentially through an aqueous phase containing some potential drug-binding molecules.

#### 1.4.3 Outer Membrane

The outer membrane of the Gram-negative cell envelope contains proteins and phospholipids (Fosberg et al., 1970a,b; Schnaitman, 1970a,b; Osborn et al., 1972; White et al., 1972), the membrane also contains variable amounts of polysaccharide (DePamphilis and

Adler, 1971; Osborn, 1971; Rothfield and Romeo, 1971). The main body of the membrane appears to consist of proteins and phospholipids (Forge and Costerton, 1973; Forge et al., 1973a), whilst the oligosaccharide portion of the lipopolysaccharide appears to be associated with the inner and outer surfaces (Cheng et al., 1971; Schnaitman, 1971). From the electron micrographs of embedded and sectioned cells (Schnaitman, 1970b) the profile of the outer membrane layer was revealed to be the same as other biological membranes, suggesting that the proteins and phospholipids form a bilayer.

The phospholipids contribute 90% of the total lipid content of the outer membrane of the Gram-negative cell, as found in the cytoplasmic membrane. They are arranged in an hexagonally close-packed bilayer, with d-spacing 0.44nm (Forge et al., 1973a; Rothfield et al., 1966; Burge and Draper, 1967) indicating similarities with a typical membrane. From the study of a marine pseudomonad, Forge et al. (1973b) showed that the hydrocarbon tails of the phospholipids are packed side by side, and suggested that these regular arrays are important in the structural integrity of the outer membrane layer. These phospholipids are centrally placed, whilst the proteins are superficially placed and less important to the integrity of the outer membrane. The phospholipids of the outer membrane of Esch. coli are quantitatively similar to those in the cytoplasmic membrane, but qualitatively different (White et al., 1972).

A cleavage plane in the outer cell wall membrane has been observed in freeze-etching studies (Dvorak et al., 1970; DeVoe et al., 1971; Forge et al., 1973a; Gilleland et al., 1973) indicating that the hydrophobic parts of the phospholipid and lipopolysaccharide molecules form a zone in the centre of the outer cell wall membrane

similar to that found in typical membranes. Thus the hydrophobic lipid A portions of the lipopolysaccharide molecules are believed to associate with the hydrophobic zone of the outer membrane, leaving the polysaccharide portions of the molecules protruding from the inner and outer surfaces of the membrane (Cheng et al., 1971; Lindsay et al., 1973).

The lipopolysaccharide of P. aeruginosa has received considerable attention, and is similar in composition to that of the Enterobacteriaceae (Clarke et al., 1965; Fensom and Gray, 1969; Chester et al., 1972, 1973; Ikeda and Egami, 1973). The major differences are the high phosphorous content (4.3%) and low sugar content (16-17%) of P. aeruginosa.

The exact role of protein in the cell envelope of P. aeruginosa is not known. Many of the proteins, especially those associated with the cytoplasmic membrane, may be the classical membrane-bound enzymes, transport proteins etc. The outer membrane of Gram-negative bacteria, however, is essentially devoid of the high levels of enzymatic activity that is characteristic of the cytoplasmic membrane (Bell et al., 1971; White et al., 1971). This implies that the outer membrane either has undiscovered enzymatic activity, or that the protein serves only a structural role. The outer membrane of Esch. coli contains a major protein which accounts for 70% of the cell wall protein (Schnaitman, 1970b). The proteins of the outer membrane of P. aeruginosa consist of three major proteins and probably their major function is to stabilise the outer membrane (Stinnett et al., 1973). Thus the proteins of the outer membrane differ from those of the cytoplasmic membrane.

The protein-lipid-lipopolysaccharide complexes of the outer membrane constitute the endotoxic O-antigens of Gram-negative bacteria. Both antigenicity and toxicity are properties associated with the lipopolysaccharide components of these complexes (Lüderitz et al., 1971; Galanos et al., 1972).

In the cell envelope lipoprotein is covalently linked to the peptidoglycan and extends outward towards the outer membrane (Braun and Rehn, 1969; Braun et al., 1970; Braun and Wolff, 1970; Schnaitman, 1971; Braun and Bosch, 1972). Schnaitman also suggested that the covalently linked lipid component of the lipoprotein anchors the outer membrane by hydrophobic interactions with the outer membrane phospholipids and that these linkages are probably the major force holding the wall together. Consistent with this suggestion is the fact that proteolytic digestion causes a separation of the outer membrane from the peptidoglycan layer (Braun and Sieglin, 1970). This covalently linked peptidoglycan-lipoprotein complex probably acts as a true structural protein and may thus serve as a rigid foundation for the whole envelope.

Clarke et al. (1967a,b,c) found that the cell envelope of P. aeruginosa was similar to other Gram-negative bacteria. It contained lipid and lipopolysaccharide (55-65%), protein (30%) and peptidoglycan (5-15%).

Following the work of Fosberg et al., (1970a,b) on a marine pseudomonad, studies on the outer layers of P. aeruginosa (Lickfield et al., 1972; Gilleland et al., 1973; Weiss and Fraser, 1973) have shown that P. aeruginosa exhibits an ultrastructure typical of Gram-negative bacteria but with some special characteristics (Meadow, 1975). A proposed structure of the cell envelope of P. aeruginosa is shown in Fig. 1.6.

FIGURE 1.6.      Diagram to show the chemical composition of the  
wall and membrane layers of P. aeruginosa

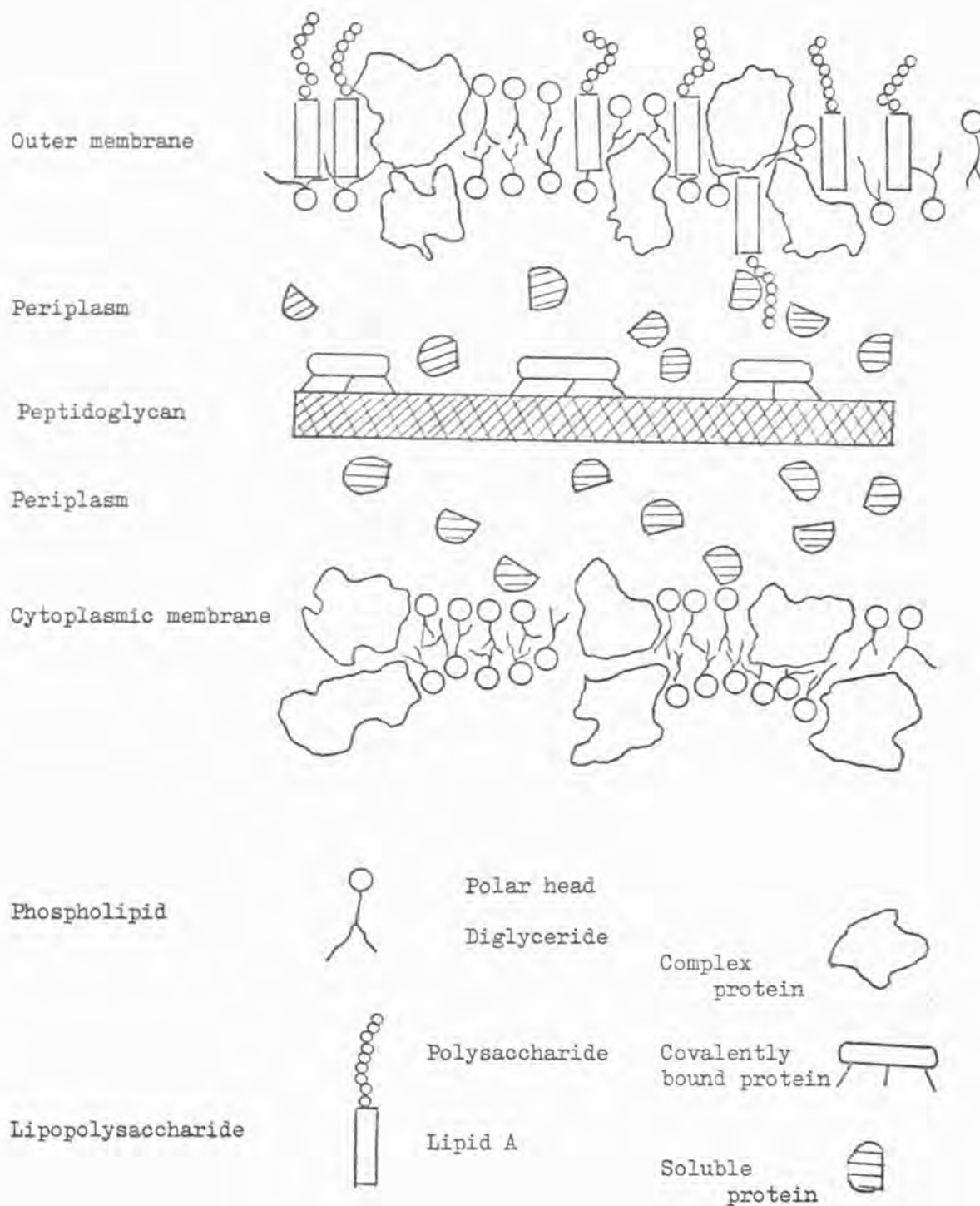

The outer membrane of *P. aeruginosa* consists of phospholipid and lipopolysaccharide arranged to form a mosaic or a lipid bilayer. The antigenic side-chains of the lipopolysaccharide probably project outwards into the surrounding environment since they can be detected serologically in intact organisms. In addition to these two components there are also proteins, some of which may be lipoproteins and glycoproteins. Apart from any slime or appendage such as flagella, the most external cell envelope structure in contact with the environment will be the distal ends of the polysaccharide parts of the lipopolysaccharide; thus any drug would have to penetrate an ordered and cross-linked 'mat' of polysaccharide chains. The lipopolysaccharide may exist as a bilayer of polysaccharide and lipid with the non-polar lipids occupying the interior of the bilayer. Hydrophobic forces are the major ones joining the two halves of the lipopolysaccharide polymer, and these forces are contributed by the non-polar lipids of the inner part of the bilayer. Hydrophobic interactions also contribute to the linear polymerization of the lipopolysaccharide. Metal cation binding probably contributes to the linking of the lipopolysaccharide subunits. The mechanism is presumably by cross-linking the polar regions of the amphipath by combination with negatively charged phosphate or carboxyl groups (Brown, 1975). The hydrophobic lipid A part of the lipopolysaccharide anchors the polysaccharide chains by being associated with the hydrophobic zones of the outer membrane. The basic continuum consists of proteins and phospholipids which are exposed between the lipopolysaccharide-oligosaccharides to a greater or lesser degree, possibly acting as patches or specific receptor 'sites'. These could consist of specialized lipopolysaccharide - phage receptors (Lindberg and Hellerquist, 1971), glycoprotein - colicin receptors (Sabet and



Schnaitman, 1973) and phospholipid (Glauert and Thornley, 1969) with the polar heads at the surface. In P. aeruginosa these phospholipids will be mainly phosphatidylethanolamine.

The Gram-negative outer membrane structure and composition are profoundly influenced by the environment, particularly conditions of specific growth limitation (McDonald and Adams, 1971; Ellwood and Tempest, 1972; Holme, 1972; Robinson and Tempest, 1973). Divalent metal ions are essential for the integrity of the cell envelope of P. aeruginosa (Eagon and Carson, 1965) and in retaining lipopolysaccharide in the outer membrane (Eagon et al., 1965; Wilkinson, 1967; Leive, 1968; O'Leary et al., 1972). Cross-linking of the lipopolysaccharide by divalent metal ions via phosphate groups is believed to maintain the integrity of the cell (Roberts et al., 1970; Wilkinson, 1970). Asbell and Eagon (1966) have suggested that divalent metal ions act as an intermediate to form ionic bonds with negatively charged subunits of the lipopolysaccharide sacculus during its biosynthesis. Calcium ions are involved in the structural integrity of the cell wall of Rhizobium trifolii stabilizing either the lipoprotein or peptidoglycan or both (Humphrey and Vincent, 1962).

Using freeze-etching studies, Lickfield et al. (1972) have shown that the outer membrane of the cell wall of P. aeruginosa contains a granular and predominately proteinaceous subunit. The removal of cell envelope divalent metal ions by Tris-ethylenediaminetetraacetic acid (Tris-EDTA) released spherical protein units from the inner part of the outer membrane envelope (i.e. adjacent to the peptidoglycan) which on addition of magnesium ions were reaggregated back into the cell envelope (Gilleland et al., 1973). Loss of these protein units caused the cells to become osmotically fragile, but stability

returned with the addition of magnesium ions. This suggests that the lipoprotein layer is a permeability barrier external to the cytoplasmic membrane which protects the peptidoglycan, a feature observed by Burman et al., (1972). Rogers et al. (1969) and Roberts et al. (1970) found a phospholipid and protein-lipopolysaccharide complex was released from the cell wall on exposure to EDTA; the major component, a protein-lipopolysaccharide, contained two major protein components both of which were glycoproteins.

The extraordinary sensitivity of Gram-negative bacteria, especially P. aeruginosa, to cold shock (Gorrill and McNeil, 1960) as well as to rapid changes in pH, temperature or tonicity (Brown and Winsley, 1969) is probably related to the structure of the outer membrane.

The outer membrane constitutes a protective barrier, susceptible to damage by a number of agents; it excludes a wide variety of molecules and also retains enzymes and structural components within the periplasmic space (Costerton et al., 1974).

### 1.5 Antibiotics

Antibiotics were originally defined as compounds produced by certain micro-organisms which, at low concentrations, are capable of inhibiting growth and other activities of competitor micro-organisms. Actinomycetes (soil saprophytes) are capable of producing substances which can destroy their competitors; from these substances antibiotics are isolated.

The chemotherapeutic era was inaugurated by Ehrlich (1913), who set out the theory of selective drug action whereby a drug would be toxic only to its target and be preferentially bound only to that target. This led to the discovery of the arsenical

agents (Voegtlin and Smith, 1920) and the sulphonamides (Domagk, 1935). However, the antibiotic era of treatment did not really commence until after the discovery of penicillin by Fleming (1929), and its development for specific use against bacteria by Florey et al. (1940).

Antibacterial substances affect one or more of the following processes taking place within the bacterial cell:

- (i) nucleic acid synthesis;
- (ii) protein synthesis;
- (iii) biochemical transformations;
- (iv) synthesis and function of the cell membrane;
- (v) growth and integrity of the cell wall.

#### 1.5.1 Penicillins

Penicillin and its analogues act upon the bacterial cell wall and as a result cell wall destruction takes place and growth is inhibited. The properties of the penicillin molecule differ according to the side chain R (Fig. 1.7). Penicillins V and G, narrow spectrum antibiotics, are the most commonly used; they are active against Gram-positive organisms such as streptococci and staphylococci. The  $\beta$ -lactam ring of these penicillins is very easily opened by the action of the enzyme penicillinase (a  $\beta$ -lactamase) which is present in an increasing number of strains of Staph. aureus. The inactivation of penicillin by penicillinase is an hydrolysis reaction which results in the formation of the biologically inactive penicilloic acid (Fig. 1.7).

Subsequent development of the penicillins led to the production of some semi-synthetic derivatives containing a carbonyl group of the amide function attached directly to a benzene or heterocyclic ring. The introduction of bulky ortho constituents in

FIGURE 1.7 The structure of penicillin and the hydrolysis reaction  
which brings about the inactivation of penicillin

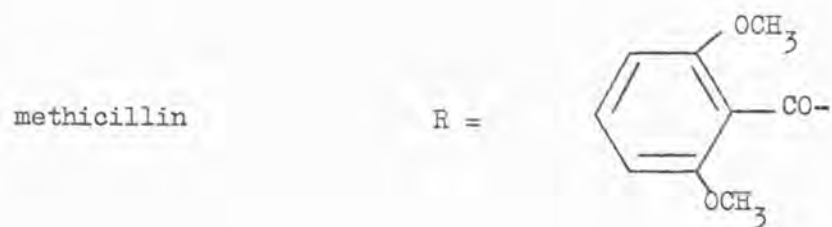
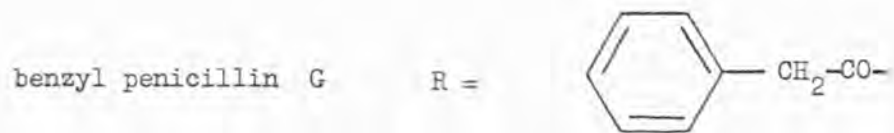
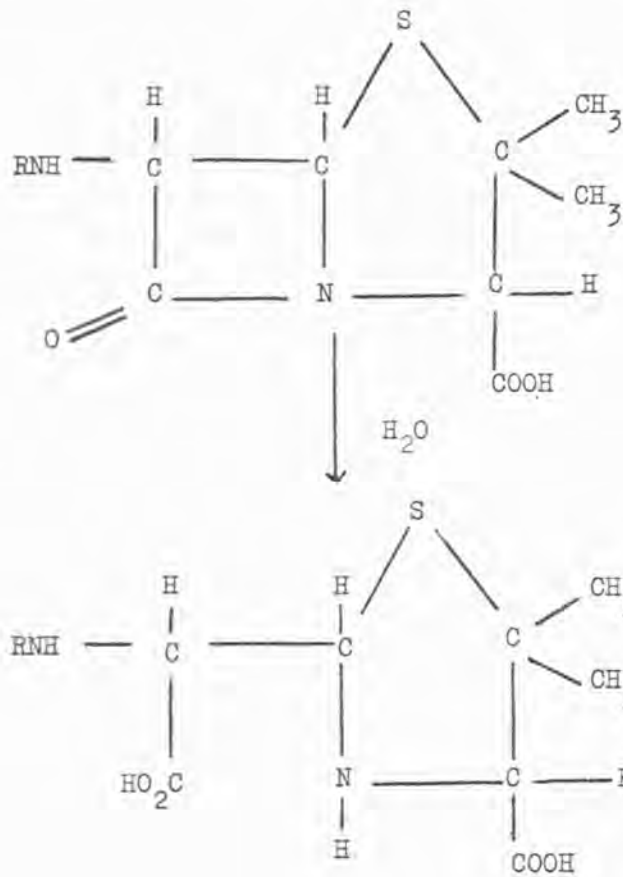

the benzene ring leads to steric hindrance and the ability of the  $\beta$ -lactamase to inactivate the penicillin molecule is reduced. Decreased hydrolysis by the  $\beta$ -lactamase is best obtained by further substitution of smaller groups in both ortho positions.

Methicillin-2,6 dimethoxyphenyl penicillin was the first semi-synthetic penicillin to show good activity against penicillin-resistant staphylococci (i.e. penicillinase producers) in vivo as well as in vitro (Rolinson et al., 1960); its action was not inhibited by  $\beta$ -lactamase production.

Penicillin acts by inhibiting the formation of the penta-glycyl peptide cross-linkages of the cell wall peptidoglycan (Tipper and Strominger, 1965) thus weakening the cell wall polymer. The delicate cytoplasmic membrane is forced through the weakened cell wall by the high osmotic pressure and cell lysis occurs. Penicillin can only lyse actively growing cells.

In the early 1960's, when the semi-synthetic penicillins and cephalosporins were introduced, a high proportion of the penicillin-resistant strains of Staph. aureus were sensitive to methicillin. However, these staphylococci have built up a resistance to the semi-synthetic penicillins with increased use of antibiotics.

Novick (1963) found that the genes for the synthesis of penicillinase in Staph. aureus were located extrachromosomally on a plasmid. These enzymes are inducible and induction usually occurred with low concentrations of a penicillinase-resistant penicillin e.g. methicillin (Benveniste and Davies, 1973). The various natural and semi-synthetic  $\beta$ -lactam antibiotics differ in their ability to induce the enzyme in Staph. aureus.

$\beta$ -lactamase production is not the sole mechanism of resistance, bacteria may be intrinsically resistant to penicillins (Sutherland, 1964) and not produce the enzyme. In all clinically methicillin-resistant strains methicillin resistance has a unique phenotypic nature, and there is no evidence for the occurrence of a methicillinase. Naturally occurring methicillin-resistant strains show a heterogenous response to methicillin; they consist of mixed populations in which the majority show a normal sensitivity to methicillin while a slow growing minority show a very high resistance (Sutherland and Rolinson, 1964). However, Annear (1968) and Parker and Hewitt (1970) have shown that the heterogenous population of methicillin-resistant strains of Staph. aureus occurs on incubation at 37°C, whereas incubation at 45°C renders all resistant cells sensitive to methicillin; on incubation at 25°C the cells are methicillin-resistant.

Seligman (1966) and Dyke et al., (1966) have shown that not all methicillin-resistant strains transduce a plasmid. However, Al-Salihi (1975) using selected methicillin-resistant strains of Staph. aureus showed that genes controlling methicillin resistance and penicillinase production are plasmid borne, but located on separate plasmids, each plasmid being lost independently of the other. Loss of the methicillin plasmid accompanied by changes in the cell surface (amounts of teichoic acid) were found to be dependent on the concentration of inorganic phosphate in the growth medium.

Cells of Staph. aureus with a natural resistance to methicillin possess an alkaline phosphatase enzyme system (Davies, 1974); there was a correlation between the production of this enzyme,

amount of surface teichoic acid and resistance to methicillin. It was concluded that the alkaline phosphatase enzyme system is the temperature-dependent enzyme system previously suggested by Annear(1968). Methicillin-resistant cells of Staph. aureus differ from methicillin-sensitive cells in that they grow more slowly, have an altered cell surface (Sabath et al., 1970) and tend to be co-resistant with a number of antibiotics, e.g. cephalosporins, but sensitive to other antibiotics e.g. fusidic acid, lincomycin, gentamicin. Thus resistance may be due to impermeability of the antibiotic.

#### 1.5.2 Aminoglycoside Antibiotics

Gentamicin is an aminoglycoside antibiotic, a group which also includes kanamycin, neomycin, tobramycin and streptomycin. Gentamicin is effective against a large number of Gram-positive and -negative bacteria (Weinstein et al., 1963; Barber and Waterworth, 1966). It is most frequently clinically used in cases of infection due to P. aeruginosa, an organism which is resistant to many antibiotics.

Gentamicin is obtained from submerged cultures of Micromonospora purpurea (Weinstein et al., 1963). Although gentamicin preparations can consist of a mixture of four components the available commercial preparations consist of a mixture of gentamicin C<sub>1</sub>, C<sub>1a</sub> and C<sub>2</sub> (Wagman et al., 1968). The structures of the gentamicins (Fig. 1.8) were determined by Cooper et al., (1967, 1970).

The initial use of gentamicin effectively eradicated most resistant strains of P. aeruginosa; however, frequent use of gentamicin led to strains which were resistant to gentamicin (Finland and Hewitt, 1971; Stone and Kolb, 1971; Witchitz and Chabbert, 1971; Bryan et al., 1973).

FIGURE 1.8

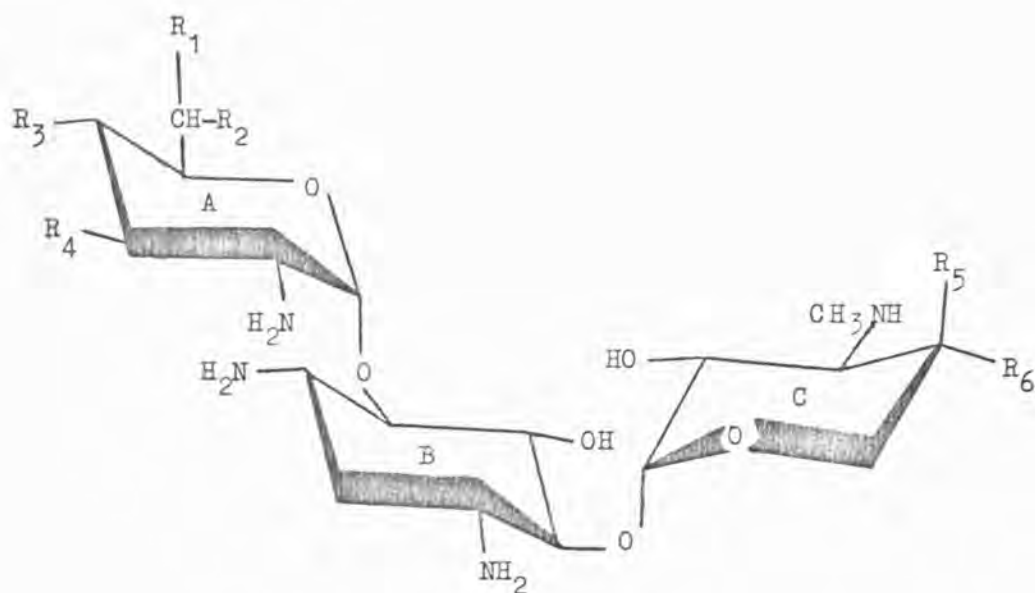
The structure of the gentamicinsKey

	R <sub>1</sub>	R <sub>2</sub>	R <sub>3</sub>	R <sub>4</sub>	R <sub>5</sub>	R <sub>6</sub>
Gentamicin A	H	OH	OH	OH	H	OH
C <sub>1a</sub>	H	NH <sub>2</sub>	H	H	OH	CH <sub>3</sub>
C <sub>2</sub>	CH <sub>3</sub>	NH <sub>2</sub>	H	H	OH	CH <sub>3</sub>
C <sub>1</sub>	CH <sub>3</sub>	NHCH <sub>3</sub>	H	H	OH	CH <sub>3</sub>

A = purpurosamine ring

B = deoxystreptamine ring

C = garosamine ring



Gentamicin inhibits bacterial growth by inhibiting protein biosynthesis (Hahn and Sarre, 1969). Along with the other aminoglycosides it acts on the smaller (30s) ribosomal subunit of the bacterial cell. The ribosomes are the cytoplasmic site of protein synthesis, a process which involves the assembling of polypeptides from L-amino acids.

Each individual amino acid is attached to a specific transfer RNA (tRNA) by enzymes and is carried to the ribosomes. The incoming tRNA is matched with a messenger RNA (mRNA) on the ribosome. The nucleotide sequence of the mRNA is governed by the DNA, thus allowing synthesis of specific proteins. Once bound on the ribosome the amino acid is attached to the adjacent nascent peptide and a translocation reaction takes place. The elongated peptide is moved to a neighbouring ribosomal binding site, thus allowing another specified amino acid molecule to be brought to the ribosome and another peptide bond to be formed.

Aminoglycoside antibiotics bind preferentially to the ribosome interfering with protein synthesis. This binding causes a misreading or miscoding in vitro resulting in incorporation of anomalous amino acids into the polypeptides to form proteins that are useless to the cell (Davies et al., 1964); this miscoding in itself is not lethal to the cell (Gorini and Kataja, 1965). The bound antibiotic causes the ribosome to attach itself to the mRNA in an aberrant fashion, irreversibly inhibiting protein synthesis and causing cell destruction (Gale et al., 1972).

#### 1.6 Antibiotic Resistance

Initially, the introduction of a new antibiotic results in widespread effectiveness against a specified spectrum of pathogenic

bacteria; with more widespread use an increasing percentage of resistant organisms develop until the antibiotic is undermined as a therapeutic agent. Such an example is the resistance of Staph. aureus to benzyl penicillin where the percentage of resistant strains increased from 17 in 1943 to 70 in 1961 (Munch-Petersen and Boundy, 1962). Similarly an increasing number of strains resistant to gentamicin and methicillin have been found with frequent use of these antibiotics.

Gale et al., (1972) have listed four possible mechanisms of antibiotic resistance:-

- (i) modification of the target in the cell;
- (ii) reduction in the physiological importance of the target;
- (iii) prevention of access to the target;
- (iv) production of drug degrading enzymes by the bacteria.

#### 1.6.1 Modification of the Target

The target is often an enzyme, and modification occurs so that the preferential binding of the inhibitor to the enzyme instead of to the substrate occurs; this results in inactivation of the inhibitor, whilst enzyme activity is retained. Such a mechanism has been observed in the binding of sulphonamides to the enzyme tetrahydropterotic acid synthetase (Hotchkiss and Evans, 1960; Ortiz, 1970).

Another example of this mechanism is found with the aminoglycoside antibiotic streptomycin. In resistant mutant cells the altered primary amino acid sequence of the P10 protein of the 30s ribosome is no longer able to bind streptomycin (Nomura, 1970). Cases are known where the modification of the target site to inactivate the inhibitor also results in inactivation of the enzyme (Cohen and Adelberg, 1958); in this case survival of the cell is ensured at the cost of metabolic efficiency.

### 1.6.2 Reduction in the Physiological Importance of the Target

The cell walls of Gram-negative bacteria contain considerably less peptidoglycan than those of Gram-positive species; other macromolecular components besides the peptidoglycan contribute towards the rigidity of Gram-negative cells. Changes in the amount of peptidoglycan in the cell envelope may contribute to the intrinsic resistance of Gram-negative bacteria to anti-peptidoglycan agents, e.g. penicillin. Such an adaptation of cells was suggested to explain the resistance to penicillin not involving  $\beta$ -lactamase production and was termed 'intrinsic resistance' (Barber, 1962); this resistance is due to inaccessibility of the target and a reduced dependence of the cell on the target.

Another example of this type of resistance occurs when P. aeruginosa is grown in magnesium-depleted medium; the resulting cells are resistant to both EDTA and polymyxin B (Brown and Melling, 1969 a,b; Gilleland et al., 1974). Under normal conditions of growth in magnesium-sufficient media cell lysis would occur in the presence of these agents.

### 1.6.3 Prevention of Access

An exclusion mechanism can prevent an otherwise active agent from achieving an effective concentration at its site of action, yet allowing the passage of essential molecules needed by the cell. The structure of the cell envelope of P. aeruginosa and especially the outer double track membrane has been shown to play a significant role in resistance to antibiotics by an exclusion mechanism. Resistance in many cases has been shown to be due to non-penetration. The cell wall of P. aeruginosa can act as a barrier to membrane active antibiotics and so confers resistance (Hamilton, 1970).

Surface lipid changes have been implicated in the resistance patterns of cells of P. aeruginosa (Pechey et al., 1974, Chapman, 1976). Ivanov et al. (1964) found that extraction of P. aeruginosa with petroleum ether enhanced the sensitivity of the cells to a number of antibacterial agents without altering cell viability.

It is possible that an exclusion mechanism may operate in conjunction with other antibiotic resistance mechanisms, such as the production of inactivating enzymes (Smith et al., 1969; Roe et al., 1971).

#### 1.6.4 Synthesis of Antibiotic-Degrading Enzymes

Resistance by antibiotic inactivating enzymes is achieved in two ways:

(i) by the production of enzymes which destroy the antibiotic. The opening of one of more covalent bonds in the antibiotic molecule may render the antibiotic inactive. For example,  $\beta$ -lactamase produced by Staph. aureus opens the  $\beta$ -lactam ring in penicillin (Scudi and Woodruff, 1949) (see Fig. 1.7).

(ii) by the production of enzymes which chemically substitute key antibiotic residues, thus rendering the antibiotic inactive. Such enzymes are found in P. aeruginosa and are capable of inactivating gentamicin.

Three different reactions are known whereby aminoglycoside antibiotics can be enzymatically modified and thus inactivated (Davies and Rownd, 1972; Benveniste and Davies, 1973): acetylation of amino groups using acetyl Coenzyme A as the source of an acetyl group; adenylation of hydroxyl groups using ATP as a source of an acetyl group; phosphorylation of hydroxyl groups using ATP as a source of a phosphate group. These enzymes are

probably located in the periplasmic space (Davies et al., 1969). If these enzymatic mechanisms operated they would confer an advantage on Gram-negative cells compared with the extracellular enzymes produced by Gram-positive cells (Percival et al., 1963). Enzymes can occur in P. aeruginosa which inactivate streptomycin, kanamycin, neomycin and chloramphenicol (Okamoto and Suzuki, 1965; Doi et al., 1968) and cephalosporin and penicillin (Sabath et al., 1965; Smith et al., 1969; Roe et al., 1971).

The acetylating enzyme attacks the free primary 6 amino groups on the 6 membered sugar (purpurosamine) or deoxy sugar rings glycosidically linked to deoxystreptamine moieties (Benveniste and Davies, 1971a); the adenylylating enzyme shows a preference for hydroxyl groups of the D-threo methylamino alcohol residue, as in streptomycin, and the phosphorylating enzyme attacks the 3'-hydroxyl groups on the 6-membered sugar or deoxysugar rings linked to deoxystreptamine moieties (Davies et al., 1971). As a result of these substrate specificities gentamicin C<sub>1</sub>, C<sub>2</sub>, and A are poor substrates for the acetylating enzyme, whilst gentamicin C<sub>1a</sub> is a good substrate; gentamicins C<sub>1</sub>, C<sub>2</sub> and C<sub>1a</sub> are poor substrates for the phosphorylating enzyme but gentamicin A is a good substrate. Acetylation of an antibiotic need not lead to inactivation but phosphorylation causes complete loss of activity.

The phosphorylating enzyme produced by P. aeruginosa is capable of inactivating the aminoglycoside antibiotics streptomycin, kanamycin and neomycin as well as gentamicin A. However, this enzyme does not inactivate commercial gentamicin (a mixture of C<sub>1</sub>, C<sub>1a</sub> and C<sub>2</sub>) since it lacks gentamicin A (Davies et al., 1969; Kobayashi et al., 1971 a,b; 1972). The gentamicin components

C<sub>1</sub>, C<sub>1a</sub> and C<sub>2</sub> each contain a purpurosamine ring, a 2,3,4,6-tetradeoxyamino sugar, which lacks the hydroxyl group targets of the phosphorylating enzyme; thus they are resistant to attack. Both gentamicin-acetylating enzymes (Mitsuhashi et al., 1971; Brzezinska et al., 1972; Bryan et al., 1974; Jacoby, 1974) and gentamicin-adenylylating enzymes (Benveniste and Davies, 1971b; Bryan et al., 1974; Kabins et al., 1974) have been reported in P. aeruginosa.

Gentamicin-inactivating enzymes present in P. aeruginosa have generally been shown to be extrachromosomally (plasmid) mediated, and the transfer of both gentamicin-acetylating and -adenylylating resistances have been reported (Bryan et al., 1973, 1974; Jacoby, 1974; Van Rensburg and De Kock, 1974; Korfhagen and Loper, 1975; Sagai et al., 1975). However Brzezinska et al., (1972) found the presence of a gentamicin acetyl transferase enzyme (GAT) in P. aeruginosa, but attempts to elucidate if GAT was determined by chromosomal or episomal genes were inconclusive.

The transfer of such plasmids (R-factors) can assist the spread of antibiotic resistance; these R-factors may be passed from resistant to sensitive strains, rendering them resistant. Molecular studies have shown that R-factors consist of two parts that are reversibly dissociable: resistance transfer factors (RTF) and r-determinants, genes that determine resistance to antibiotics (Davies and Rownd, 1972). Wanatabe (1971) has suggested that the r-determinants exist somewhere in nature as chromosomal genes and are taken up by promiscuous RTF's to form R-factors. The nature of R-factor resistance differs from chromosomally determined ribosome resistance in that it is self-transmissible, the resistance

phenotype is dominant, and cross-resistance among several aminoglycosides is common. R-plasmids in P. aeruginosa can be divided broadly into two types, those transmissible only from one Pseudomonas strain to another and those transmissible to the Enterobacteriaceae. R-plasmids responsible for gentamicin acetylation are not transmissible to Esch. coli or other Enterobacteriaceae (Jacoby, 1974).

The first three types of resistance described (1.6.1-1.6.3) do not require the acquisition of extrachromosomal genes only the modification of genes already existing.

#### 1.7 Metal Ion Resistance

Plasmid-mediated metal ion resistance has been observed in Staph. aureus cultures (Novick and Roth, 1968, Kondo et al., 1974), in Esch. coli (Smith, 1967) and in P. aeruginosa (Loutit, 1970; Summers and Lewis, 1973). The penicillinase plasmids in Staph. aureus, a series of extrachromosomal resistance factors, are known to carry determinants of resistance to inorganic ions (arsenate, lead, cadmium, mercuric, bismuth, antimony, zinc) as well as resistance to penicillin (Richmond and John, 1964; Novick and Roth, 1968). Resistance to mercury ions (Moore, 1960) is frequently a characteristic of staphylococcal strains that have become established endemically in hospitals. Mercury-resistant strains usually produce large quantities of penicillinase and are resistant also to antibiotics unrelated to penicillin (Richmond et al., 1964). There are at least three immunologically distinct staphylococcal penicillinases (Richmond, 1965).

Multiple metal resistance (mercury, cadmium, arsenate) was found in strains of P. aeruginosa (Nakahara et al., 1977). The frequency of metal resistance was higher than that of antibiotic resistance as also found in Staph. aureus strains. (Kondo et al., 1975).

## 1.8 Electrophoresis

The electrokinetic phenomena (electrophoresis, electroosmosis, sedimentation potential, streaming potential) that exist at any solid-liquid interface are due to the asymmetric distribution of ions at this interface. The experimental work undertaken is concerned with the phenomenon of electrophoresis; however, the liquid flow resulting from electroosmosis (the movement of a liquid relative to a stationary solid under the influence of an applied electric field) must be taken into consideration.

Electrophoresis occurs when, under the influence of an applied electric field, there is movement of a charged solid phase relative to a stationary liquid phase; this causes the development of a shearing plane within the electrical double layer. The potential at this plane is known as the electrokinetic or zeta potential ( $\zeta$ ), the magnitude of which determines the mobility of the particle. The electrical double layer is caused by the presence of ions of opposite sign existing in uneven distribution across the solid-liquid interface. This is due to an excess of ions at the solid phase, whereas an equal amount of ionic charge of opposite sign is distributed through the liquid phase near the interface.

The theories of Helmholtz (1879), Gouy (1910) and Chapman (1913) have been combined by Stern (1924) to describe the structure of the double layer. One of the first theories of the double layer was proposed by Helmholtz, in which the electrical double layer consists of two parallel layers of charges of uniform charge density but of opposite sign; this is virtually an electrical condenser with parallel plates no greater than a molecular distance apart, one layer being attached firmly to the surface and the other layer in the liquid. Gouy modified this theory, proposing that a diffuse



part of the double layer exists in which the potential decreases exponentially to zero over the distance  $1/K$ , the statistical thickness of the ionic layer. Equilibrium in the diffuse layer is maintained between the opposing forces of the potential field which tends to order the ions, and the forces of thermal motion which tend to redistribute the ions randomly. Stern, however, showed that neither of these theories are adequate, and produced a model for the double layer which allows for the finite size of the ion and the possibility of specific ion adsorption. He proposed that the double layer consists of two parts, a fixed part approximately a single ion in thickness in close proximity to the solid surface, in which there is a sharp fall in potential over the molecular condenser, and a diffuse layer in which there is an exponential decrease in potential over this outer atmosphere of the Gouy-Chapman theory (Fig. 1.9). In the latter region thermal agitation permits the free movement of the particles, but due to the preferential attraction of ions of opposite sign by the electrostatic field at the surface, a non-uniform distribution of ions will result and a gradual fall in potential occurs into the bulk of the liquid until the charge distribution is uniform. This theory also postulates that gegen ions (ions of opposite charge to those charge-determining ions present in excess near the surface) are adsorbed onto the surface as a result of the very strong electrical forces, or because of ionic hydration, and move with the surface. Electrical neutrality is maintained as the surface charge is of equal magnitude, although opposite in sign, to the total charge of the fixed and diffuse regions of the double layer.

FIGURE 1.9 The structure of the electrical double layer existing at a solid-electrolyte interface

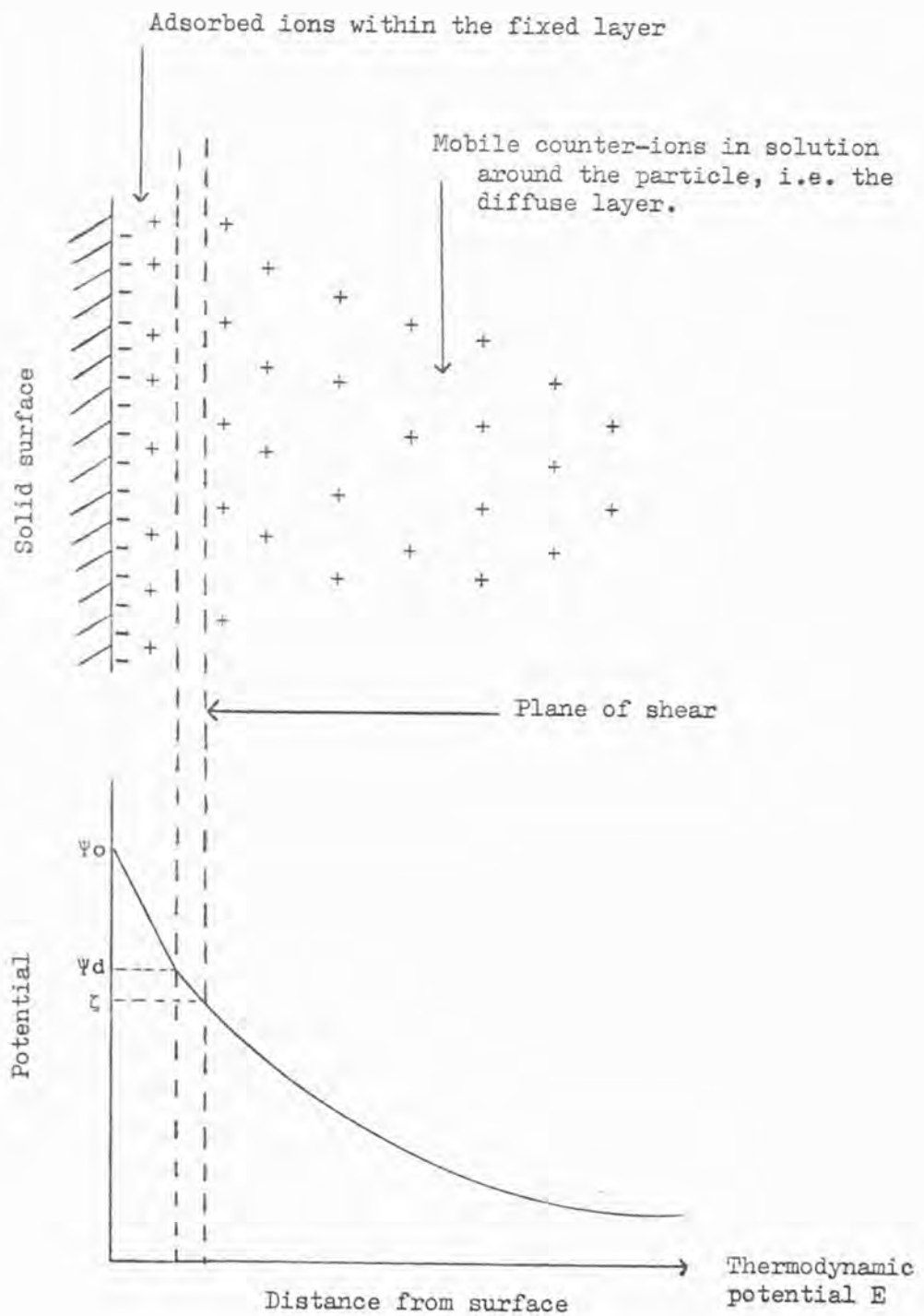

In biological cells ionogenic groups such as amino, carboxyl and phosphate which are located on the cell surface contribute to the net charge, but there is no charge due to ion adsorption on the surface (Gittens, 1962). Unlike hydrophobic sols biological cell suspensions are stable even when the zeta potential is very low, because these biological structures are composed of macromolecules which are hydrated.

#### 1.9 Particulate Microelectrophoresis

Particulate microelectrophoresis has been adapted as a method for studying the surface properties of bacteria. In this investigation a technique based on that of Ellis (1911) was used to study the electrophoretic mobility of bacterial cells. On the application of an electric field across a bacterial suspension, which is enclosed in a glass chamber, a migration of the suspended bacteria relative to the liquid occurs. The overall charge on the surface of the bacterial cell will determine whether the migration will take place towards the anode or cathode. This migration of the suspended bacteria is observed with a microscope and individual cells are timed moving across a graticule in the eyepiece.

On the application of an electric field across a closed system, not only is there movement of the suspended bacteria, but at the same time the suspending medium also moves relative to the glass surface of the observation chamber; this phenomenon, known as electroosmosis, must be accounted for. The observed particle velocity  $v_0$  is given by the expression:

$$v_0 = v_L + v_P$$

where  $v_L$  is the velocity due to electroosmosis and  $v_P$  the velocity

of the bacteria relative to the liquid,  $v_p$  is constant at all depths within the chamber. In the closed system used, which consists of a glass chamber of rectangular cross-section, the suspending medium flows along the two inside faces of the chamber towards the negative electrode, and returns through the centre, resulting in a variation of  $v_L$  and hence  $v_0$  with depth. Within such a closed system the liquid flow is being continuously deformed, and this results in the formation of two stationary liquid planes equidistant from the cell centre; thus at these planes  $v_L$  is zero and  $v_0$  is equal to the particle velocity  $v_p$ .

Komagata (1933) derived an expression for the position of the stationary levels in a cell with a width/thickness ratio  $K$  such that:

$$\frac{s}{d} = 0.500 \pm (0.0833 + \frac{32}{\pi^2 K})^{\frac{1}{2}}$$

where  $s/d$  is the fractional depth measured from the inside surface of the closed cell. For a cell with a  $K$  value greater than 20, the stationary levels are 0.21 and 0.79 of the total depth of the cell from an inside face (Abramson, 1934). The mean particle velocity  $v$  may be determined by the method of Ellis, whereby:

$$v = \frac{1}{x_1} \int_0^{x_1} v_0 dx$$

where  $x_1$  is the cell depth, and  $v_0$  the observed particle velocity at depth  $x_1$ . For a symmetrical cell the curve of  $v_0$  versus  $x$  is a parabola symmetrical about the centre.

Microelectrophoresis has recently been reviewed by James (1979b) and the cell and electrode design has been extensively reviewed by Seaman (1965) and James (1979a). It has been demonstrated (Moyer, 1936) that extremely large errors may result from the calculation of the applied field strength (X) using the applied voltage, since slight changes in the electrodes may result in large changes in the field strength without affecting the applied voltage. With the apparatus used in this investigation (Gittens and James, 1960) the applied field strength (X) is calculated from conductance and current data using the equation:

$$X = \frac{I}{qk}$$

where I/A is the current, k is the specific conductance of the suspension and  $q/m^2$  the cross-sectional area of the cell.

#### 1.10 Application of Microelectrophoresis to the Study of the Bacterial Cell Surface

The determination of the nature and quantity of the ionogenic groups on the surface of a bacterial cell by electrophoresis must be undertaken on cells which have a reproducible surface after growth and washing procedures. Thus the chemical composition of the suspending medium, pH and ionic strength must be known, defined and controlled.

Valuable information concerning the nature of surface ionogenic groups on cells of fixed age can be obtained by measuring the mobility of cells in suspensions of varying pH but constant ionic strength.

Typical pH-mobility curves obtained for simple model surfaces are shown in Fig. 1.10. Curve A is exhibited by bacterial surfaces containing only carboxyl groups exposed on the surface. This is a typical titration curve showing a plateau at higher pH values, when the carboxyl groups are fully dissociated. As the pH is decreased less dissociation occurs, and at low pH values zero mobility is observed due to the protonation of the carboxyl groups. This characteristically simple type of pH-mobility curve is exhibited by cells of Klebsiella aerogenes where the surface charge has been attributed to the presence of acidic polysaccharide (Lowick and James, 1957), and also by human erythrocytes (Seaman, 1965) due to the presence of sialic acids.

Curve B is typical of that obtained for a mixed amino/carboxyl surface containing an excess of carboxyl groups. At low pH values the surface charge is due to positively charged amino groups, but as the concentration of the hydrogen ion is decreased the positive charge on the bacterial surface is reduced due to ionisation of the carboxyl groups which gives rise to an overall negative charge. The value of the isopotential point is determined by the relative numbers of amino and carboxyl groups present, and their respective pK values. Between pH 5 and 9 a plateau region occurs where both amino and carboxyl groups are fully dissociated, the mobility being dependent on the relative numbers of amino and carboxyl groups present. Beyond pH 9 the ionisation of the amino groups is suppressed and the effective negative charge therefore increases.

FIGURE 1.10.

Typical pH-mobility curves

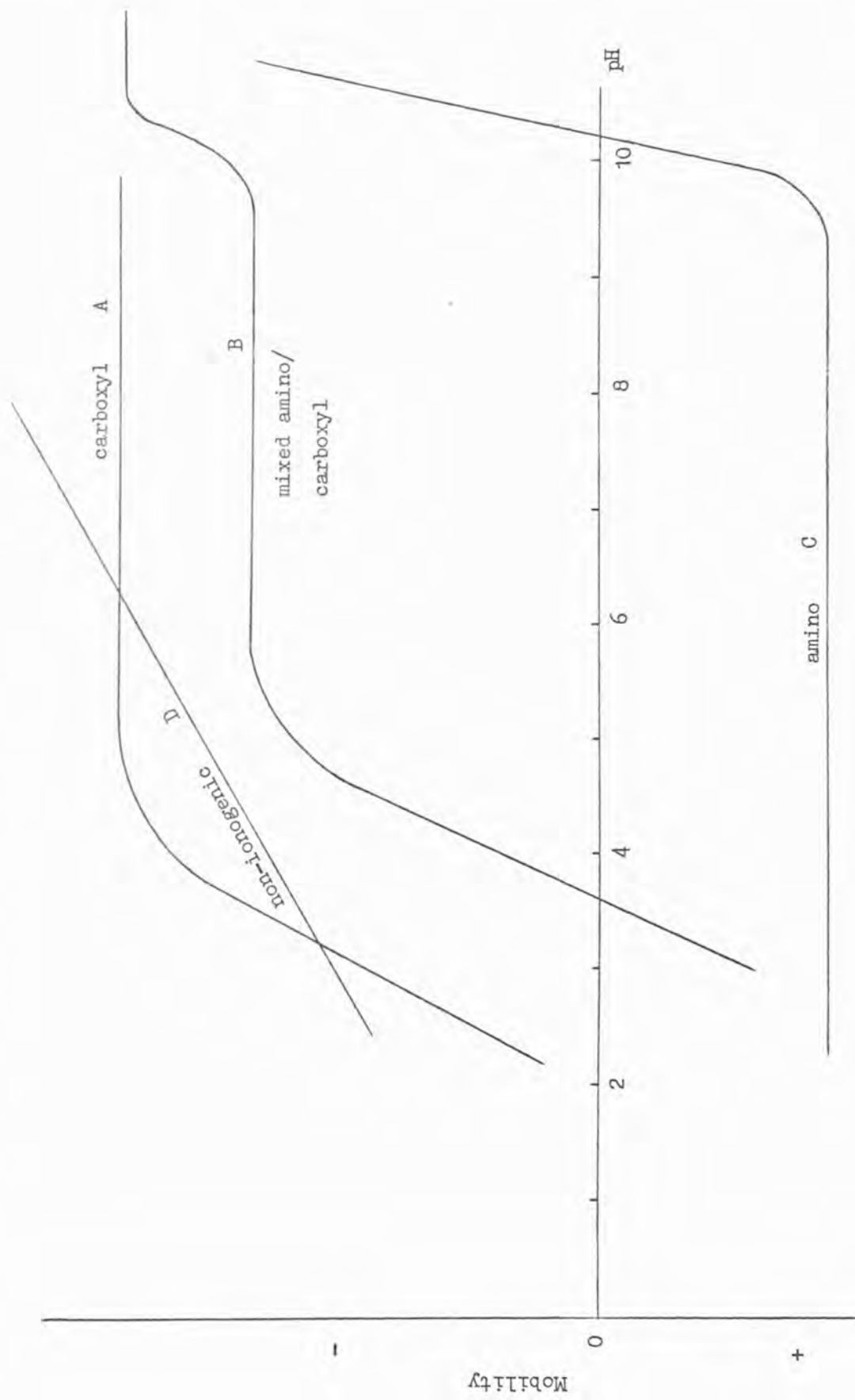

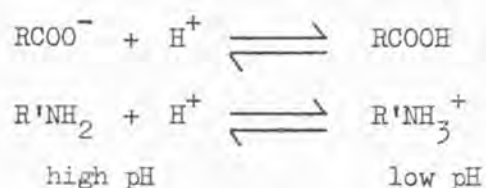

The above equations demonstrate the titration of the amino and carboxyl groups on the cell surface. Cells of Streptococcus pyogenes (Plummer et al., 1962; Hill et al., 1963) exhibit this sigmoid type pH-mobility curve.

The pH-mobility curves of cells of Staphylococcus aureus and Pseudomonas aeruginosa, which are unlike those of model surfaces, vary with respect to their resistance properties to certain antibiotics. Cells of Staph. aureus sensitive to methicillin exhibit a maximum mobility at pH 3 - 4, whereas resistant cells do not, a plateau being attained at approximately pH 6 (Hill and James, 1972a). Cells of P. aeruginosa sensitive to gentamicin are characterised by a maximum negative mobility value at approximately pH 6 followed by a minimum value at about pH 8, whereas the pH-mobility curves of gentamicin-resistant cells exhibit an increase in negative mobility value to approximately pH 7, after which, with increasing pH, some strains show a plateau whereas others exhibit a slight decrease in mobility value (Pechey and James, 1974; Chapman, 1976).

When the pH of the suspending medium is varied care must be taken to ensure that no irreversible changes can occur to the surface of the cell by using extreme pH values, which would thus render interpretation of the mobility values meaningless. The extremes of pH which produce such effects must be ascertained before mobility values are determined. Cells are suspended in buffer solutions of high and low pH and the reversibility of the mobility values of these cells is checked by rewashing the cells and measuring the mobility at pH 7. The mobility value should not differ significantly from



that of the control cells measured only at pH 7. In all work reported, pH-mobility curves were plotted over a pH range where no irreversible surface changes occurred. Variation of mobility with pH will only give information on the nature and quantity of surface ionogenic groups.

Powney and Wood (1940) observed an increase in the negative mobility value of oil droplets when measured in the presence of sodium dodecyl sulphate (SDS) adsorbed onto the surface of the oil droplets, and this resulted in orientation of the sulphate groups in an outward direction thus contributing to an increase in negative mobility. Dyar (1948) also observed a similar increase in negative mobility of bacterial cells with large amounts of surface lipid when suspended in SDS.

The method of detecting surface lipid by the measurement of electrophoretic mobility values in the presence and absence of  $0.0001 \text{ mol dm}^{-3}$  SDS revealed lipid on the cell surface of strains of Staph. aureus (Hugo and Stretton, 1966), K. aerogenes (Lowick and James, 1957) and P. aeruginosa (Pechey *et al.*, 1974). At SDS concentrations greater than  $0.001 \text{ mol dm}^{-3}$  increased and variable mobility values occur both for surfaces with and without lipid, as a result of non-specific adsorption and/or cell lysis.

## 1.11. Objects of the Present Investigation

### 1.11.1 Pseudomonas aeruginosa

Electrokinetic studies on P. aeruginosa (Pechey, 1973; Pechey and James, 1974; Chapman 1976) showed that gentamicin-sensitive and -resistant strains exhibited characteristic but different surface properties and different amounts of surface lipid. Chapman also found that over a number of years some strains lost their resistance and had changed surface properties. Excess divalent metal ions present in

the growth media affected the level of gentamicin resistance (Zimelis and Jackson 1973).

The present work was undertaken to investigate

(i) changes in the surface properties and resistance patterns of cells of gentamicin-resistant and -sensitive strains grown at 25, 37 and 43°C on two commercial media containing different concentrations of divalent metal ions;

(ii) the effects of repeated subculture at 25, 37 and 43°C in the absence of gentamicin on surface properties and resistance patterns;

(iii) the cause of the apparent increase in gentamicin resistance due to the presence of excess divalent metal ions.

#### 1.11.2 Staphylococcus aureus

Earlier electrokinetic studies on strains of Staph. aureus of human and animal origin have shown that the cell surface is complex. The surface and methicillin resistance properties of methicillin-resistant strains are affected by changes in the growth temperature (Brewer, 1966; Marshall, 1969; Hill, 1971; Hill and James, 1972a,b; Al-Salihy and James, 1972). The nature and composition of the growth media affects the surface properties and the production of the alkaline phosphatase enzyme system, the latter being present in methicillin-resistant cells (Davies and James, 1974; Al-Salihy, 1975).

The following investigations were undertaken in an attempt

(i) to establish a relationship between the complex phage-typing patterns of animal strains and their surface and biological properties (Changes in growth temperature and growth media were studied);

(ii) to compare the properties of animal strains and methicillin-resistant and -sensitive strains of human origin;

(iii) to correlate the divalent metal ion content of the cells with antibiotic resistance.

CHAPTER TWO

EXPERIMENTAL TECHNIQUES

## 2.1. Microelectrophoresis Techniques

### 2.1.1. Description of the Apparatus

The microelectrophoresis apparatus used was of the type developed by Gittens and James (1960) and is shown in Fig. 2.1.

The rectangular electrophoresis chamber (A) was constructed by the fusion of two optically flat Hysil glass plates (40 x 25 x 0.5 mm) such that the depth of the chamber was 0.5 mm. The side arms of the chamber, which consisted of 10 mm bore pyrex tubing, were sealed directly onto the chamber. They were bent in the plane of the chamber to allow immersion of the chamber into the water bath. Spherical Quickfit joints (B, C) attached to the side arms were used to secure the side arms to the electrode compartments. Glass rods were fitted around the chamber to provide structural rigidity. The electrode compartments (E, F) were fitted with high quality vacuum taps; these allowed the flow of the potassium chloride electrolyte through the electrode compartments and the passage of the bacterial suspension through the electrophoresis chamber. No. 2 sintered glass discs (G, H) were sealed as near the side arms as possible thus eliminating dead space, easing the removal of air bubbles and assisting cleaning. The silver/silver chloride electrodes were fitted into the electrode compartments, which were then filled with  $3.5 \text{ mol dm}^{-3}$  potassium chloride solution. The spherical Quickfit joints were greased and spring clips attached to ensure a leak-proof seal. Electrical contact with the bacterial suspension was made through the sintered glass discs.

The silver/silver chloride electrodes were prepared from 14 SWG 2 mm diameter silver wire. 25 cm silver wire was coiled and sealed into rubber bungs. The exposed wire was thoroughly abraded

FIGURE 2.1. Microelectrophoresis cell and electrode compartments

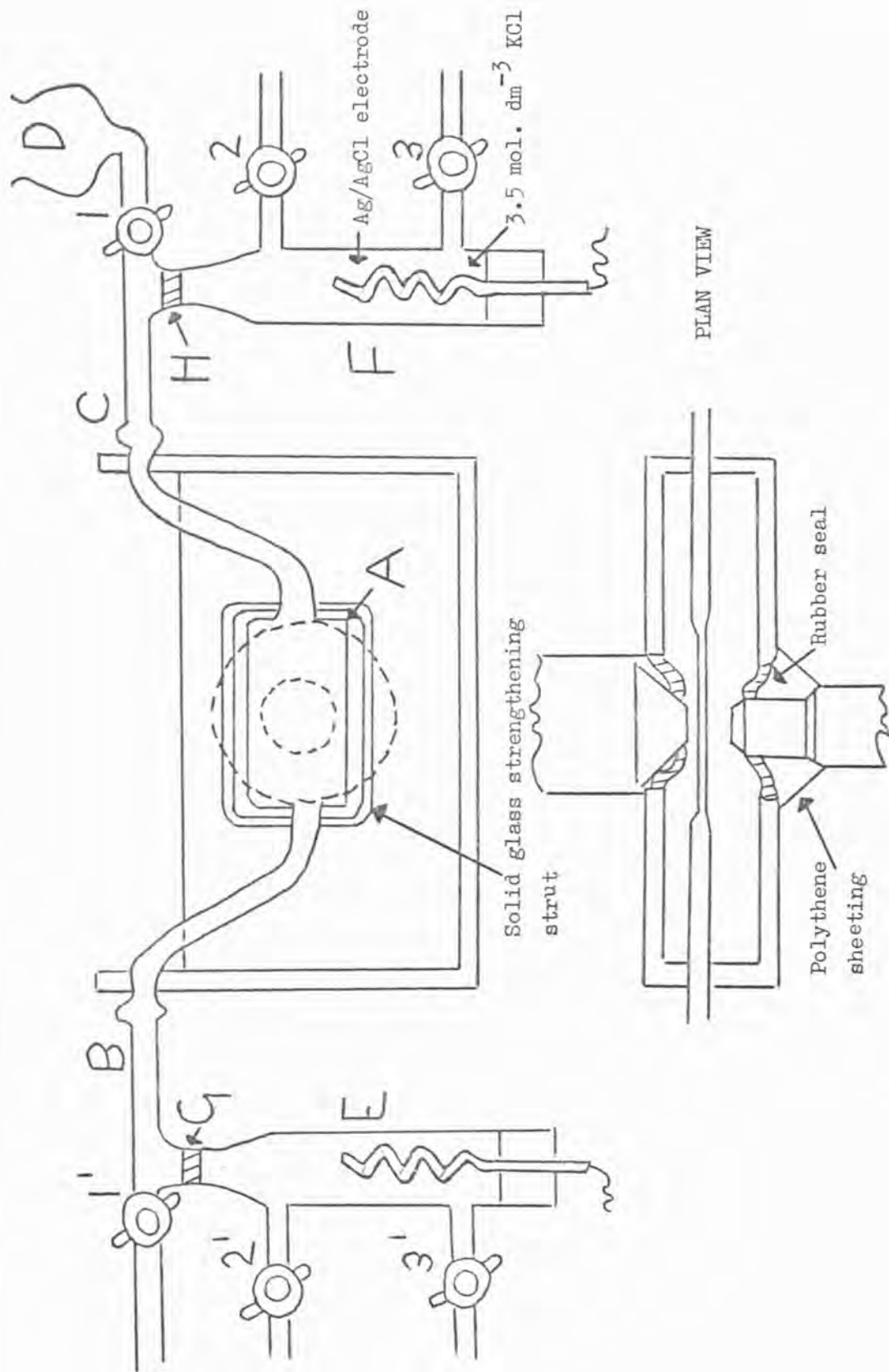

with emery paper, dipped briefly into 50% nitric acid until effervescence occurred, washed with distilled water and anodised in series in  $0.1 \text{ mol dm}^{-3}$  HCl using a platinum electrode as the cathode and a current density of  $0.25 \text{ mA cm}^{-2}$  over the whole surface area for 60 minutes until an even purple-grey coating of silver chloride was deposited on each electrode.

The apparatus used was a Rank Brothers Particle Microelectrophoresis apparatus Mark II, which consisted of an electrical circuit, microscope unit, timing device and small water bath. The latter consisted of a perspex tank with a circular well at the front to accommodate the microscope objective lens. To prevent condensation in the well and on the objective lens when the temperature of the circulating water was reduced to  $10^{\circ}\text{C}$ , the well was covered with polythene sheeting and a gentle current of warm air passed under this cover from a hot air blower. The objective lens penetrated the sheeting and could be moved freely. The chamber was mounted in a lateral position between the condenser and objective lens of the microscope by means of bolts attached to perspex clamps. Sponge foam was used as padding to protect the side arms from unnecessary strain when the chamber was rigidly clamped. The microscope system employed gave an overall magnification of X 600, and the eye piece carried a cross-hatch graticule. A low power dark ground illuminating condenser was employed to assist focusing and observation. Illumination of the electrophoresis chamber was provided by a 12 V 100 watt lamp. A quartz disc and glass heat filter were placed in the beam to eliminate the convection currents due to temperature rise changes as a result of the heating effects of the lamp. For long life the quartz-iodine illuminator was switched on at low intensity and slowly turned up. The voltage was supplied by the mains frequency and

controlled by a variable resistance.

The electrical circuit used is shown in Fig. 2.2. The current flowing through the electrophoresis chamber was measured with a milliammeter. The applied potential could be reversed using the switch R'. This switch also allowed the electrodes to be shorted when not in use to prevent polarisation.

Since the viscosity and conductivity of the buffer solution and therefore the electrophoretic mobility of the bacterial cell were temperature dependent, it was essential to maintain the bacterial suspension at a constant temperature. Therefore the electrophoresis chamber was immersed in a small water bath which was maintained at the specified temperature ( $\pm 0.5^{\circ}$  C) by the circulation of water from a larger tank thermostatically controlled by a Shandon heating and Grant cooling system. An electromagnetic timer, operating from the mains frequency, was used to record the time taken by a bacterial cell to cross a given number of squares on the cross-hatch graticule.

The bacterial suspension under examination was introduced through the funnel attached to the right-hand side of the apparatus and flushed out through rubber tubing into a reservoir containing 3% lysol solution below the bench. The chamber was fed by gravity but a partial vacuum was applied for the removal of air bubbles. The microscope was focused by movement of the objective, and the fine adjustment screw, which was calibrated over the whole of its range, was used to determine the chamber depth and to focus at the required positions within the cell.

FIGURE 2.2.    The electrical circuit for the microelectrophoresis apparatus

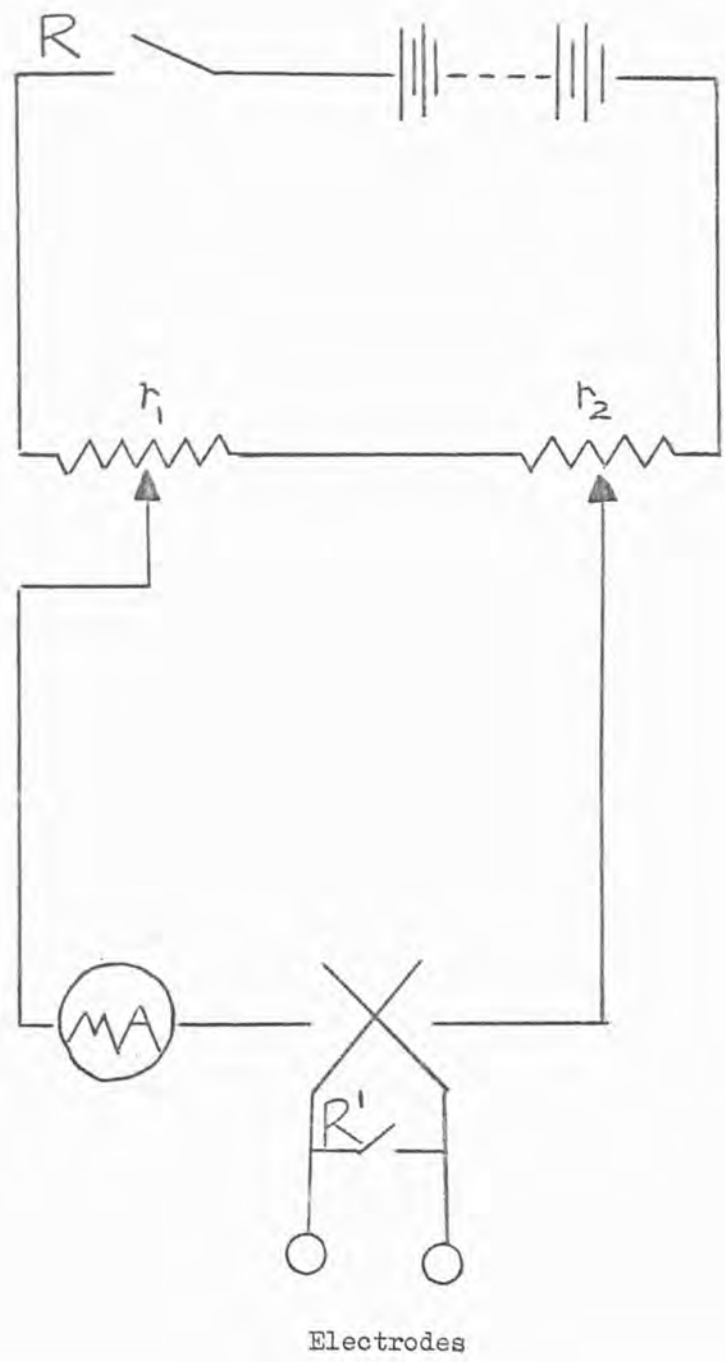



### 2.1.2. Assembly of the Observation Chamber

Before assembly of the apparatus the inner front and back surfaces of the electrophoresis chamber were coated with bacteria to enable location of these surfaces which was necessary to calculate the depth of the chamber, and to locate the position of the stationary level.

Cells of Klebsiella aerogenes were harvested, suspended in ethanol and the resulting suspension pipetted into the chamber. The chamber was then placed in an incubator at 43°C and the ethanol allowed to evaporate. By suitable manipulations of the chamber both surfaces became coated with bacteria. Subsequent washing of the chamber with distilled water removed excess bacteria but left sufficient cells adhering to the inner surfaces to make their location possible. The electrophoresis chamber was then mounted in the small perspex water tank in the lateral position between the condenser and objective lens of the microscope. Care was taken to ensure that the chamber was horizontal when viewed from the front, vertical when viewed from the side and positioned square to the optical path of the microscope. Bolts attached to the perspex bars held the chamber firmly in position. The arms were protected with sponge foam.

### 2.1.3. Mode of Operation

To ensure that the electrical connections were reproducible the following procedure was carried out daily. Approximately 50 cm<sup>3</sup> potassium chloride solution (3.5 mol dm<sup>-3</sup>) was flushed through each electrode compartment by opening taps 3 and 2, 3' and 2' (Fig. 2.1). Taps 2 and 2' were then closed and tap 1' opened. This forced the electrolyte through the sintered glass discs. Distilled water was flushed through the observation chamber (using taps 1, 1')

under pressure to remove the electrolyte which had been forced through the discs. Care was taken to ensure no air bubbles remained. The chamber was finally filled with the buffer solution at the temperature, pH and ionic strength of the bacterial suspension to be examined. The spherical joints and taps 1 and 1' were cleaned and regreased frequently to eliminate the possibility of any bacterial drifts due to ill-fitting joints.

Movement of the objective by the coarse and fine micrometer screws focused the microscope onto the bacteria coated on the front and back inner surfaces of the chamber, and from the measurements obtained on the calibration scale of the fine adjustment screw the chamber depth was obtained and the position of the front stationary level calculated. The microscope was then racked in the required amount using the fine adjustment until the calculated position of the stationary level was reached. To avoid backlash of the micrometer screw all adjustments of the microscope were made in the same direction. All measurements of the electrophoretic mobility were determined at the front stationary level.

The bacterial cell suspension was allowed to come to thermal equilibrium in the chamber. After establishing the cells exhibited only Brownian motion (i.e. no systematic drift due to various causes occurred) the electric current was switched on and adjusted to give a suitable transit time (2-4s) across a known number of squares of the graticule. The time taken for one particle to traverse a fixed distance of the graticule was determined using the electromagnetic timer. The polarity of the electrodes was reversed and the procedure repeated; 40 individual cells were measured for each suspension and the current was recorded. The chamber depth was measured before each experiment and was found to be effectively constant. The conductance of each buffer solution was measured (2.3.2).

#### 2.1.4. Theory of the Electrophoresis Chamber and Determination of Cell Symmetry

On the application of an electric field there is not only the electrophoretic migration of the cells but also a flow of liquid. This phenomenon, known as electroosmosis, results from the charged internal surfaces of the chamber. In a closed chamber there is a compensating return flow of liquid which results in a parabolic distribution of liquid velocity with depth, with maximum velocity at the centre of the chamber. The point at which the electroosmotic flow is cancelled out by the return flow of liquid is that where the observed velocity is the true electrophoretic velocity of the cells. This occurs at two positions in the chamber. These positions are known as the stationary levels and in a rectangular chamber are flat planes parallel to the sides of the cell (Fig. 2.3).

The symmetry of the electrophoresis chamber was examined by determining velocity-depth curves using cells of *K. aerogenes*. The cells were grown at 37°C for 18h, harvested and washed in preparation for electrophoresis (2.2.7). Barbiturate-acetate buffer solution of 0.02 mol dm<sup>-3</sup> ionic strength at pH 7.0 was the suspending medium. The velocity of the individual bacterial cell was measured at various positions throughout the chamber depth and thus a graph was plotted of reciprocal time against fractional chamber depth measured from the centre of the chamber (Fig. 2.4). A parabola symmetrical about the centre indicated that the chamber was perfectly acceptable for use.

FIGURE 2.3. (a) Electroosmotic flow in microelectrophoresis chamber

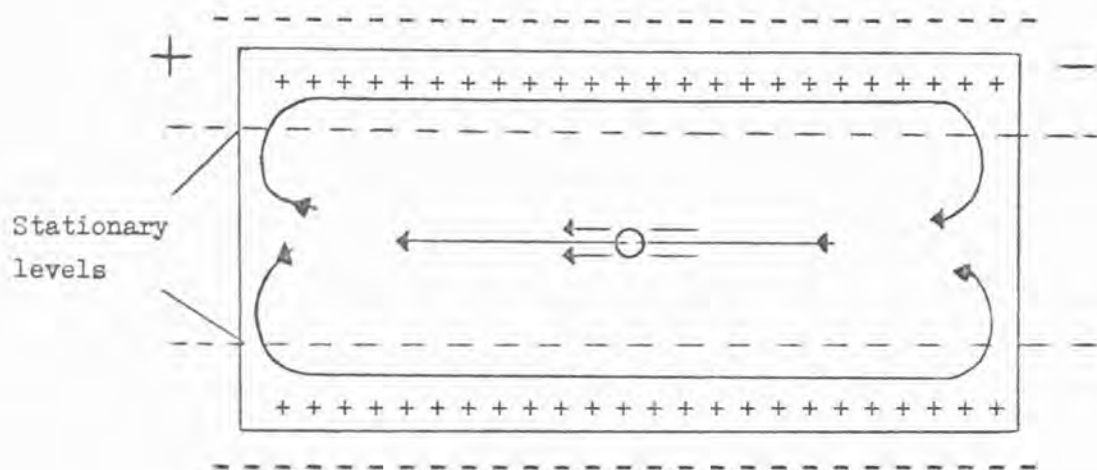

(b) Velocity gradient in microelectrophoresis chamber

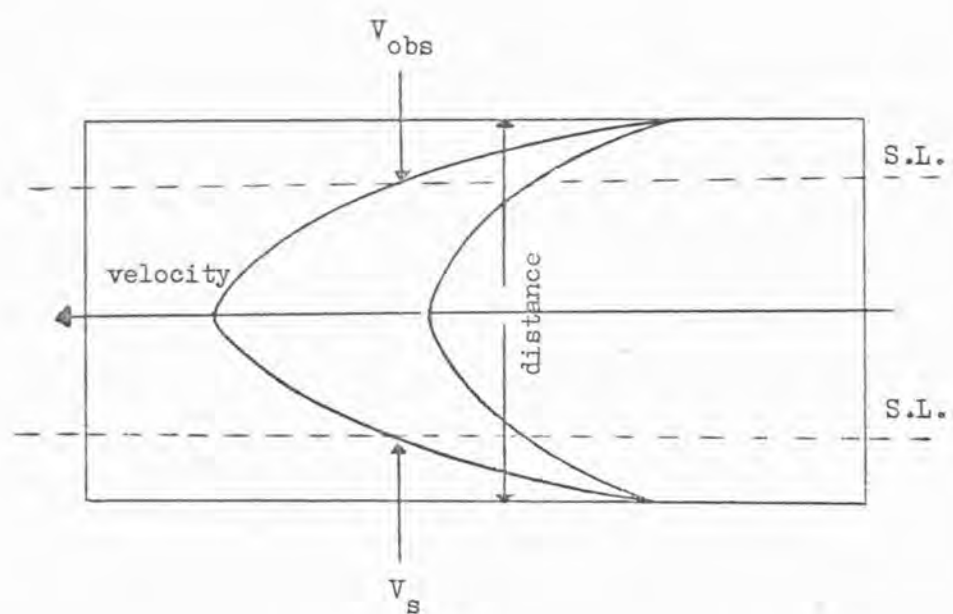
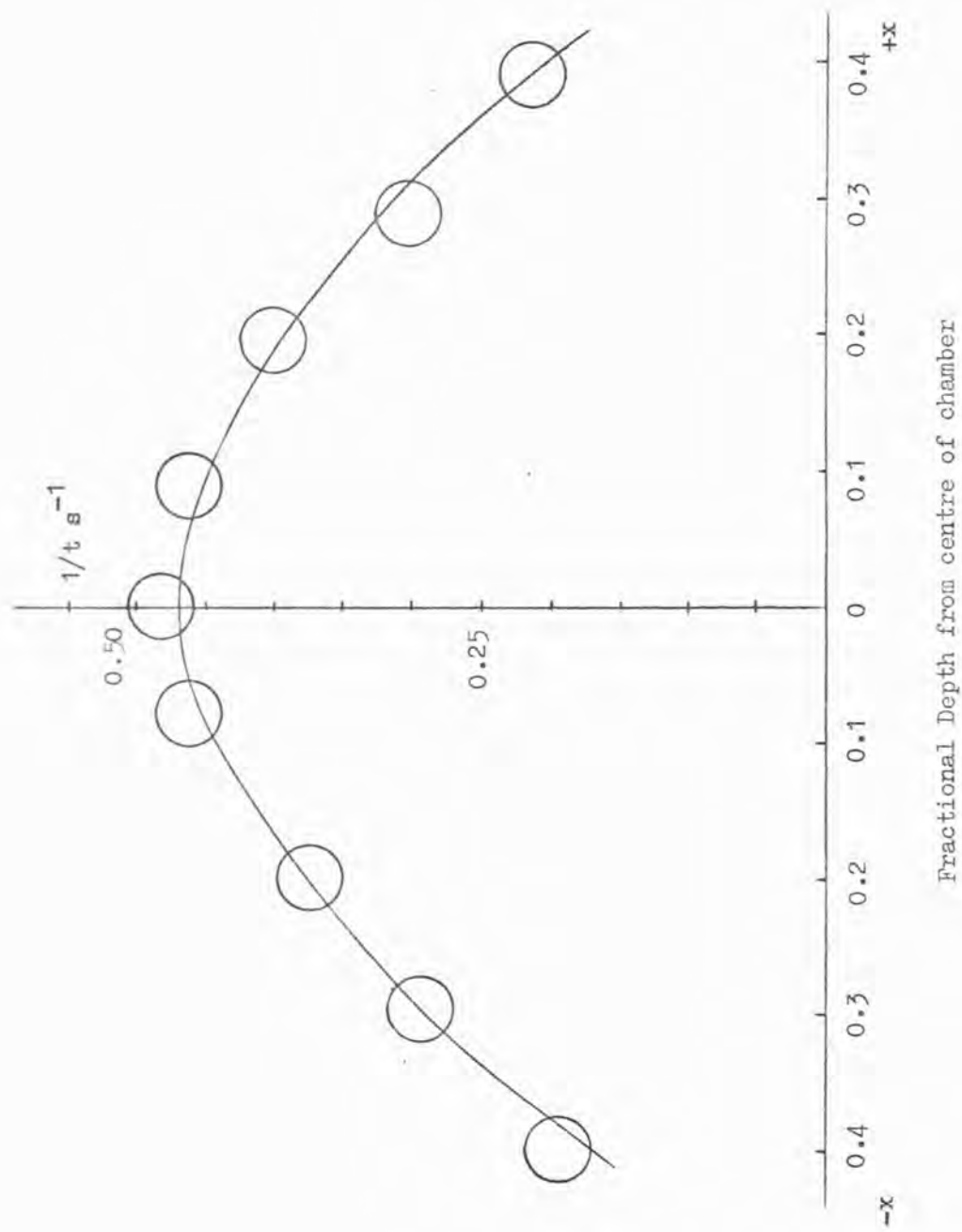

FIGURE 2.4. The velocity-depth curve of the microelectrophoresis chamber



The equation of the parabola was determined as follows:

If  $x$  is the fractional depth from the centre of the electrophoresis chamber and  $y$  the velocity (i.e. reciprocal time measured at this depth), the equation of the velocity depth parabola is of the form;

$$y = ax^2 + bx + c \quad 2.1$$

From the experimental results the constants  $a, b, c$  were calculated. The equation of the velocity-depth parabola for the cell under investigation was found to be:

$$y = -1.8614x^2 - 0.002857x + 0.4814 \quad 2.2$$

The small value of  $b$  indicates that the calculated centre of the parabola is only very slightly displaced from the geometric centre, and therefore the chamber can be accepted as symmetrical.

Integration of equation 2.2 between the limits  $x \pm 0.5$  (i.e. over the complete chamber depth) gives the value for the mean electrophoretic velocity  $y$  which was calculated to be  $0.3264 \text{ s}^{-1}$ . Using this value in equation 2.2 gives the values of  $x$  for the positions of the stationary levels. The two positions of the stationary levels were calculated to be  $+0.288$  and  $-0.289$  from the cell centre indicating that the stationary levels are located at fractional depths of  $0.212$  and  $0.789$  from the front inner surface. These positions are in close agreement with those predicted theoretically for an electrophoresis chamber (Komagata, 1933).

#### 2.1.5 Calculation of Electrophoretic Mobility

The electrophoretic mobility of a particle  $\bar{v}/m^2s^{-1}V^{-1}$  is defined as the particle velocity  $v/ms^{-1}$  per unit potential gradient  $X/Vm^{-1}$ , and is given by the expression:

$$\bar{v} = \frac{v}{X} = \frac{nL}{t} \cdot \frac{qK_s}{I} = \frac{nL}{t} \cdot \frac{qJG}{I} \quad 2.3$$

Where  $nL/m$  is the distance travelled ( $n$  being the number of squares of side  $L/m$ ) in time  $t/s$ ;  $q/m^2$  is the cross-sectional area of the chamber; and  $I/A$  the current flowing.  $K_s/\text{ohm}^{-1} \text{ m}^{-1}$  is the conductivity of the suspension obtained from the measured conductance  $G/\text{ohm}^{-1}$  and the cell constant  $J/\text{m}^{-1}$  of the conductance cell. The values of  $G$ ,  $I$  and  $t$  are measured experimentally.

Since measurement of the cross-sectional area of the electrophoresis chamber is not possible a standard particle of known mobility  $\bar{v}_s$  was timed in the electrophoretic chamber and the cell constant  $K$ , which included the cell constant  $J$  of the conductance cell, was determined. The pH and ionic strength of the suspending medium must however be known and constant. The cell constant  $K$  is given by:

$$K = LqJ = \frac{\bar{v}_s t I}{nG} \quad 2.4$$

Where  $\bar{v}_s$ , the mobility of the standard particle K. aerogenes, was obtained by extensive studies of its mobility against that of human erythrocytes (Gittens, 1962; Pechey, 1973) and has the values  $-1.67 \times 10^{-8} \text{ m}^2 \text{ s}^{-1} \text{ V}^{-1}$  at  $25^\circ\text{C}$  in  $0.02 \text{ mol dm}^{-3}$  barbiturate-acetate buffer solution at pH 7.0;  $-1.45 \times 10^{-8} \text{ m}^2 \text{ s}^{-1} \text{ V}^{-1}$  at  $10^\circ\text{C}$  in  $0.005 \text{ mol dm}^{-3}$  barbiturate-acetate buffer solution at pH 7.0.  $G$ ,  $I$  and  $t$  are the conductance of the buffer solution, current and time respectively for the standard particle.

K was determined before each set of electrophoretic measurements daily to ensure there were no changes in mobility which could be attributed to changes in the apparatus constant.

The mobility of the bacterial cells under examination was calculated using the following equation:

$$\bar{v} = \frac{KnG'}{t'I'} \quad 2.5$$

Where  $t'$ ,  $I'$  and  $G'$  are the corresponding values of time, current and conductance respectively obtained for each set of experiments.

All mobility values will be quoted as a single number without sign or units. For example, a value of 1.67 indicates that the particle is negatively charged with an electrophoretic mobility towards the cathode of  $1.67 \times 10^{-8} \text{ m}^2 \text{ s}^{-1} \text{ V}^{-1}$

In the event of particles having a positive mobility, the mobility values will be prefixed +.

## 2.2 Bacteriological Techniques

### 2.2.1 Strains

The bacterial strains used in this work, listed in Tables 2.1 and 2.2, were obtained from the following sources:

#### Pseudomonas aeruginosa

- (1) Mr. J.T. Magee, Nicholas Research Institute, 225 Bath Road, Slough, Buckinghamshire;
- (2) Dr. E. Schoutens, Brugmann Hospital, Institut Pasteur du Brabant, Bruxelles, Belgium;
- (3) Mr. Slocombe, Beecham Research Laboratories, Brockham Park, Betchworth, Surrey;



Table 2.1.

Strains of P. aeruginosa

Strain	Antibiotic Resistance	Source
1	S	1
100	Gm	2
104	Gm	3
Smith 2234	Gm	4
PL11	RPL11 (Gm, Cb, Sm, Tc, Su, Cm)	5
Capetown No 18	pMG1 (Gm, Sm, Su) GAT <sub>1</sub>	6
PU21	Sm, Rm, ilv <sup>-</sup> leu <sup>-</sup>	6

Table 2.2.

Strains of Staph. aureus

Strain	Antibiotic Resistance	Source
13136/60	PG(pen <sup>+</sup> ), Sm, Tc, Mt	7
Oxford	S	7
9341/67	S	7
Animal	(see Table 8.3)	7
(15 strains, see Table 8.2)		

Gm, gentamicin; Rm, rifampicin; Cb, carbenicillin; Sm, streptomycin; Tc, tetracycline; Su, sulphonamide; Cm, chloramphenicol; Mt, methicillin; PG, penicillin G; S, sensitive; pen<sup>+</sup>, penicillinase producer; GAT<sub>1</sub>, gentamicin acetyl transferase 1; nutritional requirements for isoleucine and valine (ilv<sup>-</sup>), leucine (leu<sup>-</sup>)

- (4) Dr. A.R. Ronald, Health Sciences Centre, University of Manitoba, Winnipeg, Manitoba, R3E 0Z3, Canada;
- (5) Dr. J.C. Loper, Department of Microbiology, University of Cincinnati Medical Centre, Cincinnati, Ohio, 45267;
- (6) Dr. G.A. Jacoby, Massachusetts General Hospital, Boston, Massachusetts, 02114.

Staphylococcus aureus

- (7) Cross Infection Reference Laboratory, Colindale Avenue, London.

2.2.2 Preparation of the Growth Media

(i) Nutrient Broth (B1) Oxoid CM1 nutrient broth was prepared by dissolving 13g in 1 dm<sup>3</sup> distilled water. The media was sterilized by autoclaving at 15 p.s.i. for 20 minutes. Approximately 30 cm<sup>3</sup> broth in 100 cm<sup>3</sup> medical flats was used for the subculture of K. aerogenes and small quantities of P. aeruginosa. Where larger volumes of bacterial suspension were required as, for example, in the subculture of strains of P. aeruginosa for EDTA lysis, 200 cm<sup>3</sup> of sterile nutrient broth in 500 cm<sup>3</sup> medical flats was used. The bottles were stored, tightly capped, at room temperature until required (Tables 2.3, 2.4).

(ii) Nutrient Agar (A1) 10g of Oxoid nutrient agar No.1 was added to a 1 dm<sup>3</sup> solution of nutrient broth (B1). The medium was dissolved by heating and finally sterilized (Table 2.3).

(iii) Nutrient Agar (A3) 28g of Oxoid nutrient agar CM3 was suspended in 1 dm<sup>3</sup> distilled water, heated to dissolve and sterilized (Tables 2.3, 2.4).

(iv) Nutrient Agar (A4) - by precipitation of inorganic phosphate from Oxoid nutrient broth (B1). Current batches of Oxoid CM1 nutrient broth (B1) contain relatively large quantities of inorganic phosphate which affects the phosphatase activity of the cells of Staph. aureus 13136. A preparation of a

Table 2.3.

Summary of growth media used

Medium	Batch no.	Code in text
Oxoid nutrient broth CM1	014 16227	B1
Oxoid nutrient broth CM1	014 16227	A1
solidified with agar no. 1	045 8640	
Oxoid nutrient agar CM3	92 19410	A3
Oxoid nutrient broth CM1	014 16227	A4
treated with Ca(OH) <sub>2</sub> and	045 8640	
solidified with agar no. 1		
Oxoid nutrient broth CM1	014 16227	B4
treated with Ca(OH) <sub>2</sub>		

Table 2.4.

The constituents of Oxoid nutrient agar and nutrient broth

Constituents*	Oxoid CM3 (Agar A3)	Oxoid CM1 (Broth B1)
Lab Lemco powder (Oxoid L29)	1g	1g
Yeast Extract (Oxoid L20)	2g	2g
Peptone (Oxoid L37)	5g	5g
Sodium chloride	5g	5g
Agar No. 3** (Oxoid L13)	15g	-

\* Analysis, Oxoid Limited, Basingstoke, Hampshire.

\*\* Agar No. 3: moisture, < 5%; ash, 4%; sulphate, 1.3%; calcium, 7220  $\mu\text{g cm}^{-3}$ ; magnesium, 1782  $\mu\text{g cm}^{-3}$ .

Table 2.5.

Concentration of inorganic phosphate present in the  
growth media

Growth media	A1	A4	B1	B4
Phosphate/ $\mu\text{g cm}^{-3}$	58	8	52	10

suitable medium has been established previously in this laboratory (Davies, 1974; Al-Salihy, 1975) from which excess inorganic phosphate was removed by the addition of  $4.7 \text{ cm}^3$  of 10% calcium hydroxide suspension to 13 g Oxoid CM1 nutrient broth dissolved in  $100 \text{ cm}^3$  distilled water. The resulting suspension was allowed to stand for 20 minutes. The medium was then rapidly filtered using acceleration papers and Whatman No. 5 filter papers. The pH of the supernatant was adjusted from 9.5 - 10 to pH 7 by the addition of dilute HCl and the solution diluted to  $1 \text{ dm}^3$ . Oxoid No. 1 agar was added to give a final concentration of 1%. The agar was dissolved by heating and the medium sterilised by autoclaving (Table 2.3).

All growth media were sterilized by autoclaving for 15 minutes at 15 p.s.i.

(v) Preparation of Agar Plates Agar plates were prepared by transferring approximately  $20 \text{ cm}^3$  molten sterile agar aseptically to sterile petri dishes. The agar was allowed to set on a flat surface at room temperature.

(vi) Agar Plates containing Antibiotics Gentamicin, a heat stable antibiotic, could be added to the agar before sterilization by autoclaving. Heat labile antibiotics such as methicillin and rifampicin could not be autoclaved, these were added aseptically to the sterile molten agar which had been allowed to cool to  $45^\circ\text{C}$ . Rifampicin was added as a solid and the medium shaken thoroughly to disperse the antibiotic. Rifampicin dissolved with standing in the solidified agar. Methicillin was added to the agar in solution form. Freshly prepared solutions were used since it rapidly loses its activity in solution.

Strains of P. aeruginosa and Staph. aureus were inoculated onto agar plates containing A3 and A1/A4 media respectively.

### 2.2.3 Growth and Maintenance of Strains

Strains of Staph. aureus and P. aeruginosa were inoculated once using a sterile platinum loop onto the relevant broth or agar media required for experimental purposes from an agar storage plate and incubated for 18h at 37°C prior to subculturing in the quantities required for examination. This procedure overcame lag due to storage and any other effects through change of media from slope to examination media. Cells of these cultures were used as inoculum for the test suspensions which were incubated for 18h at temperatures of 25, 37 and 43°C. For inoculation of larger volumes of nutrient broth 1 cm<sup>3</sup> of the 'starter culture' in broth was aseptically added to 200 cm<sup>3</sup> of B1 medium, K. aerogenes (NCTC 418), the strain used for calibration of the electrophoresis apparatus, was inoculated into approximately 30 cm<sup>3</sup> nutrient broth Oxoid CM1 (code B1, Table 2.3) in a loosely capped medical flat and incubated at 37°C for 18h. The strains were maintained and stored as follows:

Strains of P. aeruginosa and Staph. aureus were subcultured in duplicate bimonthly onto slopes of A3 and A4 media respectively contained in 25 cm<sup>3</sup> universal bottles, and incubated for 18h at 37°C. All strains were stored at 4°C. K. aerogenes was maintained by regular subculturing in nutrient broth (B1).

### 2.2.4 Growth of Cells during Repeated Subculture at Different Temperatures

Cells of P. aeruginosa were initially subcultured from the parent slopes onto agar (A3) for 18h at 37°C. Cells from these plates were then inoculated onto fresh nutrient agar (A3) plates and

incubated overnight at different temperatures of 25, 37 and 43°C. Cells grown at each temperature were repeatedly grown for twenty or more subcultures at these growth temperatures after which measurements of mobility, MIC, etc. were recorded.

#### 2.2.5 Cleaning and Sterilization of Apparatus

All contaminated glassware was autoclaved at 15 p.s.i. for 15 minutes before washing thoroughly with hot water, rinsed several times in distilled water and dried at 105°C. Contaminated disposable apparatus was immersed in 1% lysol solution. Pipettes and Pasteur pipettes were dried, plugged with non absorbent cotton wool and stacked in sealed cannisters. These were sterilized in the autoclave.

#### 2.2.6 Determination of Growth Curves of *P. aeruginosa*

For the determination of growth curves of *P. aeruginosa* at 25, 37 and 43°C, 200 cm<sup>3</sup> solutions of sterile nutrient broth (B1) were each inoculated with 1 cm<sup>3</sup> of an 18h culture grown at 37°C in broth. These inoculated suspensions were incubated at 25, 37 and 43°C with vigorous stirring and small samples taken aseptically at regular intervals. The absorbance of each suspension was measured at 625 nm against a blank of distilled water. Growth curves were plotted at each temperature of absorbance versus time.

#### 2.2.7 Preparation of Cells for Electrophoresis

The following procedures for harvesting and washing the bacterial cells were found to produce reproducible mobility values of the cells, i.e. a reproducible cell surface after removal of any adsorbed material such as components of the growth media without causing damage to the cell surface. (*P. aeruginosa*: Pechey, 1973; *Staph. aureus*: Brewer, 1966).

The bacterial cells grown on agar were harvested by washing with distilled water, sedimented out by centrifugation and the supernatant removed. Cells grown in broth were immediately centrifuged, the supernatant removed and the cells washed once with distilled water. Cells of P. aeruginosa were washed twice in barbiturate-acetate buffer solution ( $I = 0.005 \text{ mol dm}^{-3}$ ) at the required pH. Staph. aureus cells were washed once in barbiturate-acetate buffer solution ( $I = 0.02 \text{ mol dm}^{-3}$ ). Cells of K. aerogenes were washed twice in barbiturate-acetate buffer solution at the ionic strength and pH corresponding to that required for preparation of the test cells. All bacterial cells were finally resuspended in barbiturate-acetate buffer solution at the pH and ionic strength used during the washing procedure to a population density of about  $3 \times 10^8$  organisms  $\text{cm}^{-3}$ ; the mean mobility value of the cells in each suspension was then measured.

#### 2.2.8 Antibiotic Susceptibility Tests

##### (i) Minimum Inhibitory Concentration (MIC) of Gentamicin

The minimum inhibitory concentration (MIC) of an antibacterial agent (ie. the lowest concentration of antibiotic required to inhibit growth) was measured by the method of Gould (1960).

(a) Nutrient Broth (B1) The MIC of gentamicin for each strain was measured at 25, 37 and 43°C. Firstly strains of P. aeruginosa prior to repeated subculture were grown at 25, 37 and 43°C for 18h in broth from cultures on agar at 37°C to produce approximately  $10^9$  bacteria  $\text{cm}^{-3}$ . Strains which had been repeatedly subcultured were grown overnight in broth at the temperature of repeated subculture prior to measurement of MIC at the above temperatures.

A series of nine 2-fold dilutions of gentamicin solution in nutrient broth were prepared and 5 cm<sup>3</sup> of each in metal capped test-tubes was sterilized by autoclaving. The sterile media were inoculated with the required bacterial suspension to give approximately a 10<sup>5</sup> inoculum cm<sup>-3</sup>. Controls of the inoculated and sterile nutrient broth which contained no gentamicin were included to check growth and sterility conditions. Three series of gentamicin solutions were inoculated with one culture from one growth temperature, and these were incubated at 25, 37 and 43°C. Thus the MIC values, which were recorded at 24h intervals could be obtained at each growth temperature and variations due to temperature of growth noted. In general the maximum MIC value was reached after 48h incubation at 37°C and 96h incubation at 25, 43°C.

(b) Nutrient Agar (A3) Strains of P. aeruginosa were grown for 18h at the required temperature on agar. Cells of these strains were used as inoculum by streaking a loopful of the culture onto a series of agar plates containing 2-fold serial dilutions of gentamicin to give approximately 10<sup>5</sup> bacteria cm<sup>-3</sup>. The cultures were incubated at 25, 37 and 43°C and the MIC values recorded.

(ii) Disc Diffusion Test

Sterile antibiotic discs were obtained from Mast Laboratories Limited, Liverpool. Strains of Staph. aureus were subjected to the presence of the following antibiotics to determine their resistance/sensitivity patterns: penicillin G (4 units); methicillin (10µg cm<sup>-3</sup>); chloramphenicol (25µg cm<sup>-3</sup>); streptomycin (10µg cm<sup>-3</sup>); erythromycin (5µg cm<sup>-3</sup>); tetracycline (25µg cm<sup>-3</sup>).



The plates for disc diffusion tests were prepared by aseptically pipetting 20 cm<sup>3</sup> molten agar (A1 or A4) onto 8.5 cm<sup>3</sup> diameter sterile petri dishes and allowing the agar to set on a horizontal surface to form a uniform layer of 2.4 mm thickness. The plates were dried in the inverted position until the surface of the agar was free from visible moisture. Cells of strains of Staph. aureus were streaked onto either agar A1 or A4 to produce individual colonies after 18h incubation at 37°C. Portions of the relevant sterile nutrient broth (B1 or B4) were inoculated with 1 colony cm<sup>-3</sup> of each strain under examination and incubated at 37°C for approximately 6h until the solutions became turbid, yielding about 10<sup>5</sup> bacteria cm<sup>-3</sup>. The turbid bacterial suspensions were added to the agar plates by the method of flooding: approximately 2 cm<sup>3</sup> of these bacterial suspensions were aseptically pipetted onto the surface of the prepared plate which was tilted in several directions to ensure it was thoroughly coated. Excess fluid was removed with a sterile pipette and the plates allowed to dry. The antibiotic discs were applied individually to the agar with sterile fine pointed forceps allowing adequate spacing (> 2 cm) between discs, and pressed gently to ensure complete contact with the agar. This method of inoculation produced a uniform, nearly confluent lawn of growth covering the whole surface of the plate and not a continuous film which would produce smaller zones of inhibition and therefore erroneous results.

Because the results of disc diffusion tests vary with a number of experimental conditions that are difficult to standardize it was necessary to evaluate the results by comparison with a control of known sensitivity; Staph. aureus Oxford was the control used in the experiments. Strains were incubated at 25, 37 and 43°C. Results were interpreted by comparison of the diameter of the strain under examination with that of the control culture and recorded as follows:

- Sensitive if the diameter of inhibition is greater, equal to, or not more than 4mm less than the control culture;
- Moderately Sensitive if the diameter is at least 12mm, but reduced by over 4mm as compared with control;
- Resistant if the diameter is not greater than 10mm.

When assessing penicillinase-producing staphylococci, a large inhibition zone was often observed; a sharp heaped up edge, consisting of full size colonies which contrasted markedly with the smooth tapering edge of the control, if present, was recorded as resistant.

The methicillin resistance properties of staphylococci cannot be tested at 37°C alone, as these cells show a heterogeneous response to methicillin resistance with temperature (Sutherland and Rolinson, 1964)

#### 2.2.9 Detection of Surface Lipid on Cells of *P. aeruginosa*

The surface lipid of cells of *P. aeruginosa* was detected by comparison of the mobility values of cells suspended in barbiturate-acetate buffer solution containing a low concentration of sodium dodecyl sulphate (SDS) - an anionic surface active agent, with the mobility values of the control cells.

Cells to be treated with SDS were harvested as normal, washed once in distilled water, and twice in buffer solution ( $0.005 \text{ mol dm}^{-3}$ ) at pH 7.0 containing SDS at a concentration of  $0.0001 \text{ mol dm}^{-3}$ , and finally resuspended in this solution for mobility measurements. The control cells were harvested and washed in buffer solution of the same ionic strength and pH, but in the absence of SDS. An increase in negative mobility of greater than 10% in the presence of SDS was considered to be significant and indicative of the presence

of surface lipid. The size of the increase was an indication of the amount of neutral surface lipid present. The S-value is expressed as a percentage of the difference in mobility value between treated and control cells, over the mobility value of the control.

#### 2.2.10 Treatment of Cells of *P. aeruginosa* with Ethylenediaminetetraacetic Acid

##### (i) Electrophoretic Measurements

18h old cells of *P. aeruginosa* grown at 37°C in nutrient broth (B1) and nutrient agar (A3) were harvested, and suspended in barbitalurate-acetate buffer solutions pH 7.0 containing a sublethal concentration (approximately 1/4 MIC) of the disodium salt of ethylenediaminetetraacetic acid (EDTA). Cells of resistant and sensitive strains 100 and 1 with MIC values of 3201 and 388  $\mu\text{g cm}^{-3}$  to EDTA respectively (Pechey, 1973) were suspended in EDTA solutions containing 931 and 93  $\mu\text{g cm}^{-3}$  for strains 100 and 1 respectively. The suspensions were incubated at 37°C for 30 minutes. After centrifuging out of the EDTA solutions the cells were washed once in distilled water, twice with, and finally resuspended in 0.005 mol  $\text{dm}^{-3}$  barbitalurate-acetate buffer solution at pH 7 for mobility measurements. As control, cells grown on the same media, harvested and washed under normal conditions in barbitalurate-acetate buffer solution pH 7 were used.

##### (ii) Lysis with EDTA

Cells of *P. aeruginosa* were grown at 37°C for 18h on A3 or B1 media in duplicate in large quantities (200  $\text{cm}^3$  broth; 10 agar plates per strain). The cells were harvested and washed aseptically three times with 0.05 mol  $\text{dm}^{-3}$  barbitalurate-acetate buffer solution (pH 8.6). The control cells were suspended in barbitalurate-acetate

buffer solution (pH 8.6). Cells to be treated were suspended in barbiturate-acetate buffer solution containing  $0.01 \text{ mol dm}^{-3}$  EDTA at pH 8.6. All suspensions were adjusted with buffer solution to given an initial absorbance of approximately 0.7 at 660 nm against a buffer solution blank. The suspensions were left stationary at  $30^{\circ}\text{C}$  and their absorbances measured at regular intervals. Graphs of absorbance against time were plotted for control and test suspensions.

#### 2.2.11 Growth of *P. aeruginosa* in the Presence of Gentamicin

Cells of *P. aeruginosa* were grown in duplicate at  $37^{\circ}\text{C}$  for 18h in nutrient broth (B1) or nutrient agar (A3) containing subinhibitory concentrations of gentamicin (approximately one seventh MIC value). Thus the growth media contained 0.028, 353 and  $1130 \mu\text{g cm}^{-3}$  gentamicin for strains 1, 104 and 100 respectively. Control cells were similarly grown in broth and on agar but in the absence of gentamicin. The cells were harvested, washed and prepared for electrophoresis (2.2.7).

#### 2.2.12 Transfer of R-factors between Donor and Acceptor Strains of *P. aeruginosa*

Strains which contain R-factors are resistant to gentamicin and sensitive to rifampicin; these are classified as donor strains. The recipients of R-factors - acceptor strains, are sensitive to gentamicin yet resistant to rifampicin. Attempts were made to produce gentamicin-resistant, rifampicin-resistant transconjugants by mating the R-factor strains Capetown and PL11 with the acceptor

strain PU21. The MIC of rifampicin is greater than  $1600 \mu\text{g cm}^{-3}$  for cells of PU21.

Cells of the parent strains grown at  $37^{\circ}\text{C}$ , and cells repeatedly subcultured at 25, 37 and  $43^{\circ}\text{C}$  on agar (A3) were grown once in broth (B1) at the relevant temperature and from these cells exponentially growing cultures (approximately 6h) of donor and acceptor strains in nutrient broth (B1) at  $37^{\circ}\text{C}$  were obtained and mixed in the ratio of 1:3 and 2:2 in nutrient broth to give  $0.4 \text{ cm}^3$  in a total volume of  $2 \text{ cm}^3$ . These mixtures were incubated in a medical flat lying horizontal at  $37^{\circ}\text{C}$  for 24h. Controls of donor and acceptor strains unmated ( $0.4 \text{ cm}^3$ ) were also grown. After mating  $0.1 \text{ cm}^3$  of each culture was inoculated onto nutrient agar (A1) plates containing gentamicin  $10 \mu\text{g cm}^{-3}$  and rifampicin  $300 \mu\text{g cm}^{-3}$  and incubated at  $37^{\circ}\text{C}$  for 18h. Transconjugant cells which grew were those in which the R-factor controlling gentamicin resistance had been transferred from the donor strain. These colonies were transferred to nutrient broth (B1) for determination of gentamicin resistance (2.2.8).

Nutrient agar (A1) was chosen for selection of transconjugants since the MIC values of the acceptor strain PU21 (Table 5.6) showed that these cells had become resistant to gentamicin on agar A3.

#### 2.2.13 Determination of Metal Ion Resistance using the Disc Diffusion Technique

Sterile discs of diameter 6.5 mm were obtained from Mast Laboratories Limited, Liverpool.

The metal solutions were prepared from Analar reagents at a suitable concentration to give the required metal salt content per disc.

Each disc contained one metal salt of which the concentration per disc was as follows:

Cadmium sulphate	$3\text{CdSO}_4 \cdot 8\text{H}_2\text{O}$	20 $\mu\text{g}$
Copper sulphate	$\text{CuSO}_4 \cdot 5\text{H}_2\text{O}$	20 $\mu\text{g}$
Magnesium sulphate	$\text{MgSO}_4 \cdot 7\text{H}_2\text{O}$	40 $\mu\text{g}$
Zinc sulphate	$\text{ZnSO}_4 \cdot 7\text{H}_2\text{O}$	20 $\mu\text{g}$
Phenylmercury nitrate basic	$\text{C}_6\text{H}_5\text{HgOH} \cdot \text{C}_6\text{H}_5\text{HgNO}_3$	13 $\mu\text{g}$
Sodium arsenate	$\text{Na}_2\text{HAsO}_4 \cdot 7\text{H}_2\text{O}$	32 $\mu\text{g}$

The solutions containing cadmium, copper, zinc and magnesium ions were sterilized by autoclaving, whereas the solutions containing arsenate and phenylmercury ions were sterilized by heating to  $60^\circ\text{C}$  and cooling several times to avoid decomposition.

The sterile discs were individually impregnated with  $0.02\text{cm}^3$  of a sterilized metal ion solution using a sterile Agla micrometer syringe (Luer fitting). These discs were stored in sterile petri dishes at  $4^\circ\text{C}$  over silica gel.

Strains of Staph. aureus were examined for metal ion resistance on agar (A1 or A4) using the flooding technique (2.2.8).

#### 2.2.14 Detection of Penicillinase

The starch agar method used for the detection of penicillinase was based on a modification of the method of Perret (1954).

This method is very sensitive, allowing for the detection of as little as 0.05 units of enzyme per  $\mu\text{g}$  dry wt of organism.

Strains of Staph. aureus were grown in sterile nutrient broth (B4) in metal capped test-tubes at  $37^\circ\text{C}$  for approximately 6h to give a bacterial concentration of approximately  $10^5$  cells  $\text{cm}^{-3}$ .  $0.1\text{cm}^3$  of a  $10^5$  dilution was aseptically spread onto starch agar plates containing 0.2% w/v starch in nutrient agar (A4) and the plates were inoculated for 18h at  $37^\circ\text{C}$ . A 'developing' solution was prepared by adding  $2\text{cm}^3$  of  $0.16\text{mol dm}^{-3}$  iodine/ethanol to Sørensen's phosphate

solution ( $0.32 \text{ mol dm}^{-3} \text{ Na}_2\text{HPO}_4 \cdot 12\text{H}_2\text{O}$ ;  $0.32 \text{ mol dm}^{-3} \text{ KH}_2\text{PO}_4$ ) pH 5.9, containing  $10^6$  units of benzyl penicillin. The starch agar plates were flooded with approximately  $2 \text{ cm}^3$  of the above solution. The agar was stained a deep blue due to the reaction between starch and iodine; penicillinase colonies were recognised by the appearance of a white halo around the colony this is caused by the production of penicilloic acid, a breakdown product of penicillin by penicillinase. Penicillinase-negative colonies were stained a deep yellow which gradually faded.

#### 2.2.15 Treatment of Cells of Staph. aureus with Sodium Metaperiodate

The technique of treatment with sodium metaperiodate modified after Garrett (1965) and Brewer (1966) was used to destroy and remove teichoic acid from the surface of Gram-positive bacteria.

18h old cells of Staph. aureus were harvested with distilled water, washed once with physiological saline (0.89% w/v NaCl) and then resuspended in  $0.1 \text{ mol dm}^{-3}$  aqueous ammonia to remove any ester linked alanine. The cells were washed in water to remove the free alanine and aqueous ammonia, suspended in a solution of  $0.02 \text{ mol dm}^{-3}$  barbiturate-acetate buffer solution at pH 6 containing sodium metaperiodate ( $0.05 \text{ mol dm}^{-3}$ ) and placed in a water bath at  $37^\circ\text{C}$  for 30 minutes. The cells were finally washed twice with and resuspended in buffer solutions at the appropriate pH and ionic strength ( $0.02 \text{ mol dm}^{-3}$ ) for mobility measurements.

### 2.3. Chemical Techniques

#### 2.3.1 Preparation of Barbiturate-acetate Buffer Solutions for Electrophoresis Suspensions

Barbiturate-acetate buffer solutions were used as the suspending electrolyte (Michaelis, 1931).

A stock solution of  $0.5 \text{ mol dm}^{-3}$  barbiturate-acetate buffer solution was prepared from the following salts:

$0.15 \text{ mol dm}^{-3}$	Sodium barbitone	$30.927 \text{ g dm}^{-3}$
$0.15 \text{ mol dm}^{-3}$	Sodium acetate, hydrated	$20.414 \text{ g dm}^{-3}$
$0.20 \text{ mol dm}^{-3}$	Sodium chloride	$11.680 \text{ g dm}^{-3}$

Analar grade reagents and glass distilled water were used.

A  $2 \text{ dm}^3$  solution was prepared and filtered through sintered glass fitted with a millipore filter and finally stored at  $4^\circ\text{C}$ . The ionic strengths required for experimental purposes were obtained by dilution of the stock solution with distilled water and the pH adjusted by the addition of dilute HCl ( $1.0 \text{ mol dm}^{-3}$ ) or NaOH ( $1.0 \text{ mol dm}^{-3}$ ). Measurements of pH were made with an E.I.L. pH meter (Model 23 A) using a glass/calomel electrode assembly. The conductance of each buffer solution prepared was measured in a bottle type conductance cell at  $25.0$  or  $10.0^\circ\text{C}$  ( $\pm 0.01^\circ\text{C}$ ) using a Wayne Kerr Universal Bridge (Model B221).

#### 2.3.2 Determination of the Divalent Metal Ion Content of Staph. aureus and P. aeruginosa Strains by Atomic Absorption

Atomic absorption is used to determine the concentration of an element (metal) in a sample by measuring the absorption of radiation in atomic vapour produced from the sample at a wavelength characteristic and specific of the element (metal) under consideration.



Cells of Staph. aureus were grown on nutrient agar (A1 or A4 media) and cells of P. aeruginosa on nutrient broth (B1) or nutrient agar (A3) for 18h at 37°C in large quantities. Cells were harvested and washed three times with glass distilled water and the suspension filtered through muslin to remove any agar particles. The suspension was concentrated by centrifugation and resuspended in a small volume of water (approximately 20 cm<sup>3</sup>) and dried to constant weight at 105°C. For comparison purposes 10-15 cm<sup>3</sup> samples of the media were also dried at 105°C. The dried bacteria were crushed, and a known weight (about 0.2g) was taken. The bacterial samples, together with the media samples and reagent blanks were wet ashed using the technique of Eagon (1969). The samples were digested slowly with 10 cm<sup>3</sup> of an acid mixture containing 60 - 62% perchloric, concentrated nitric and concentrated sulphuric acids in the ratio 2:5:1 v/v. When the solution became clear the temperature was raised until fumes of sulphuric acid were evolved and the volume was reduced to 2 - 3 cm<sup>3</sup>. The solutions were made up to 10 cm<sup>3</sup> with glass distilled water and suitable dilutions taken depending on the metal concentration range required by the atomic absorption spectrophotometer. Each sample was tested in duplicate. Standard solutions containing 100 µg cm<sup>-3</sup> were prepared from Analar grade reagents for each metal to be analysed. Relevant dilutions were carried out to give a series of standard solutions required to calibrate the optimum range chosen for each metal. Due to interference of ions such as aluminium and phosphate during the analysis of calcium and magnesium ions all standard solutions and test samples prepared for determination of these ions contained strontium chloride solutions of 1000 and 500 µg cm<sup>-3</sup> for magnesium and calcium ions respectively.

### 2.3.3. Determination of the Inorganic Phosphate Content of the Growth Media

The concentration of free inorganic phosphate in the various growth media was analysed using a quantitative spectroscopic method (James and Prichard, 1974). Analar  $\text{KH}_2\text{PO}_4$  previously dried at  $110^\circ\text{C}$  was used to prepare standard solutions for calibration over the range  $10\text{--}50 \mu\text{g P cm}^{-3}$ . The media to be tested were prepared as normal (2.2.2) and  $2 \text{ cm}^3$  of each diluted to  $10 \text{ cm}^3$ . The molten agar was cooled to approximately  $40^\circ\text{C}$  before pipetting. The standard solutions, media and distilled water blank were treated as follows:  $2 \text{ cm}^3$  of each solution was treated with  $2 \text{ cm}^3$  60% perchloric acid followed by  $2 \text{ cm}^3$  amidol reagent (2g 2,4-diaminophenol hydrochloride and 40g sodium metabisulphite in  $200 \text{ cm}^3$  distilled water, filtered and stored in a darkened environment) and finally  $1 \text{ cm}^3$  8.3% ammonium molybdate solution (containing 1 drop 0.88  $\text{NH}_3$  to aid solubility). The solutions were diluted to  $25 \text{ cm}^3$  with distilled water and the absorbances of these solutions and treated distilled water were measured at 730 nm against the untreated blank. The absorbance of all solutions was measured after the same time interval from the start of the reaction to allow equal rate of development of colour since this was greatly affected by atmospheric conditions. A straight line calibration graph of absorbance against concentration of inorganic phosphate was plotted from the absorbance values of the standard solutions, and from the absorbance reading the concentration of free inorganic phosphate present in the media was calculated. The concentration of inorganic phosphate present in the growth media is listed in Table 2.5. (2.2., page 82).

#### 2.3.4. Chemical Analysis of Bacterial Cells

##### (i) Growth and Preparation of Cells for Dry Weight Determinations

Cells of *P. aeruginosa* were grown for 18h at 37°C in nutrient broth (B1) and nutrient agar (A3) from the storage slopes. 200 cm<sup>3</sup> of sterile broth was inoculated with 1 cm<sup>3</sup> of bacterial suspension in broth, the agar plates were inoculated from an 18h culture on agar with a sterile platinum loop. The inoculi were incubated for 18h at 25, 37 or 43°C. The bacterial growth was harvested and the cells washed four times in 0.89% saline and finally resuspended in saline to give an absorbance of approximately 0.6 at 625 nm against a saline blank. The absorbance value was recorded. Part of the bacterial suspension in saline was used to prepare a series of dilutions, with absorbance values which evenly covered the calibration range of 0.1 to 0.6. Eight 15 cm<sup>3</sup> samples of undiluted stock (A approximately 0.6) were dried to constant weight at 105°C. Saline blanks were included for the saline correction.

Standard curves were plotted of absorbance against dry weight /mg cm<sup>-3</sup>. The dry weight of the bacterial suspension under chemical analysis could therefore be determined from its absorbance and related to the amount of protein or polysaccharide. After dry weight determination the remainder of the suspension was analysed as soon as possible. Standard curves were produced for each analytical procedure.

##### (ii) Estimation of Protein by the Biuret Method

Standard solutions of bovine serum albumin in the range 1 - 20 mg cm<sup>-3</sup> were prepared (for calibration purposes) in 0.89% saline solution. 3 cm<sup>3</sup> samples of the bacterial suspensions previously prepared (2.3.4 (i)) in duplicate, standard solutions and saline blank were pipetted into boiling tubes contained in an ice bath. 1.5 cm<sup>3</sup> of 3.0

mol dm<sup>-3</sup> sodium hydroxide solution was added to each tube and the solutions boiled for 10 minutes. The solutions were then cooled to 0°C and 1.5 cm<sup>3</sup> of a 5% copper sulphate solution added to each tube. The tubes were sealed with parafilm and thoroughly shaken. After 15 minutes at room temperature the solutions were transferred to 25 cm<sup>3</sup> universal bottles and the precipitated copper hydroxide removed by centrifugation. The absorbance of each of the violet supernatant solutions was measured at 550 nm against the saline blank and the protein contents read off the standard curve.

(iii) Estimation of Polysaccharide by the Anthrone Method

The anthrone reagent determines total hexose content, and other carbohydrates are unlikely to interfere when present in considerable excess.

Standard solutions of D-glucose were prepared in the range 0.025 to 0.1 mg cm<sup>-3</sup> in 0.89% saline solution. The anthrone reagent, required as a fresh solution, was prepared each day by the addition of 30 cm<sup>3</sup> distilled water to 0.2g anthrone, 100 cm<sup>3</sup> pure uncontaminated concentrated sulphuric acid was slowly added to this; care was taken to ensure the anthrone was completely dissolved. 8 cm<sup>3</sup> absolute ethanol was added to the cooled solution and the reagent again cooled; a clear yellow solution was obtained. 1 cm<sup>3</sup> samples of standard solutions, test suspensions (in duplicate) and saline blank were pipetted into boiling tubes standing at 0°C and 10 cm<sup>3</sup> of the anthrone solution was added to each. The tubes were transferred to a boiling water bath for 10 minutes to allow hydrolysis to take place and finally cooled in ice water. The absorbance of the green solution was measured at 625 nm and the polysaccharide content of the test suspensions obtained from the standard curve of D-glucose.

CHAPTER THREE

THE SURFACE AND BIOLOGICAL PROPERTIES

OF CELLS OF P. AERUGINOSA

The experiments described in this chapter were undertaken to examine the effect of growth temperature and nature of the growth medium on the surface properties and gentamicin resistance of cells of P. aeruginosa. Changes in surface properties were studied using electrophoresis.

Under the experimental conditions used by Chapman (1976) the electrokinetic properties of cells grown on nutrient agar or in nutrient broth were not significantly different. Thus two commercial media were chosen, Oxoid nutrient broth CM1 (B1) and Oxoid nutrient agar, CM3 (A3), the latter containing large amounts of divalent metal ions (Tables 2.4, 6.2). Liquid media are the most convenient for numerous evaluations of MIC and solid media the most suitable for continuous subculture experiments (Chapter 4) and storage purposes. B1 and A3 media will be referred to simply as broth and agar.

Cells of P. aeruginosa were grown once from the parent strains on to the required medium (agar or broth) at 37°C for 18h, and cells of these cultures used as inoculum for pH-mobility curves, MIC and surface lipid determinations at 25, 37 and 43°C on the same medium.

### 3.1. MIC of Gentamicin for P. aeruginosa Strains

The minimum inhibitory concentration (MIC) of an antibacterial agent is defined as the lowest concentration of antibiotic required to prevent growth. The definition of gentamicin resistance is based on the findings of Jao and Jackson (1963) and Wersall et al., (1969), that serum levels of gentamicin greater than 12 to 15  $\mu\text{g cm}^{-3}$  are seriously ototoxic and clinically unacceptable. Therefore cells of P. aeruginosa resistant to gentamicin are defined as those which have an MIC greater than 12  $\mu\text{g cm}^{-3}$  and cells with an MIC less than 12  $\mu\text{g cm}^{-3}$

as gentamicin-sensitive. This definition has been used in the assessment of gentamicin resistance for MIC values obtained on both agar and broth.

### 3.1.1. The Effect of Temperature and Time of Incubation on the MIC of Gentamicin and on the Growth Rate of Cells of *P. aeruginosa*

Cells of *P. aeruginosa* were grown in broth in the presence of varying concentrations of gentamicin at 25, 37 and 43°C after an initial growth at 37°C for 18h in the absence of gentamicin (2.2.8.). The MIC values were recorded at 24h intervals (Table 3.1); an incubation time of 96h was required to obtain the maximum MIC value at each temperature for all the strains studied.

Control growth curves were obtained at 25, 37 and 43°C in broth (2.2.6) (in the absence of gentamicin) to assess variations in lag phase and maximum cell mass with temperature. The growth rate of cells grown at 37 and 43°C was similar and greater than that of cells grown at 25°C. The lag phase for cells grown at 25°C (Fig. 3.1) was longer than for cells grown at 37°C (the optimum growth temperature for cells of *P. aeruginosa*) but the maximum bacterial masses were similar. The lag phase of cells grown at 43°C was similar to that of cells grown at 37°C but there was a reduction in maximum cell mass.

Cells grown at 43°C had a reduced MIC value compared with cells grown at lower temperatures, which in strain Smith could not be correlated solely with changes in lag phase, growth rate or final cell mass.

### 3.1.2. The Effect of Growth Temperature and Nature of the Growth Medium on the MIC of *P. aeruginosa*

After growth in broth at 37°C strain 1 was gentamicin-sensitive and the other three strains were gentamicin-resistant (Table 3.2). These results are in general agreement with those of Chapman (1976) carried out under the same experimental conditions. At 25°C the

Table 3.1.

The effect of temperature and time of incubation on the MIC of gentamicin for broth-grown cells of *P. aeruginosa*

Strain	Incubation Temp/°C	24h	MIC/ $\mu\text{g cm}^{-3}$ after incubation/h	
			48h	96h
1	25	0.2	0.2	0.2
	37	0.2	0.2	0.2
	43	0.05	0.1	0.1
100	25	500	2000	8000
	37	8000	8000	8000
	43	<250	4000	4000
104	25	78	312	2500
	37	156	1250	5000
	43	39	156	625
Smith	25	12.5	25	50
	37	25	25	25
	43	0.78	0.78	0.78



FIGURE 3.1. Growth curves of cells of *P. aeruginosa* strain 104 grown in nutrient broth (B1) at 25, 37 and 43°C.

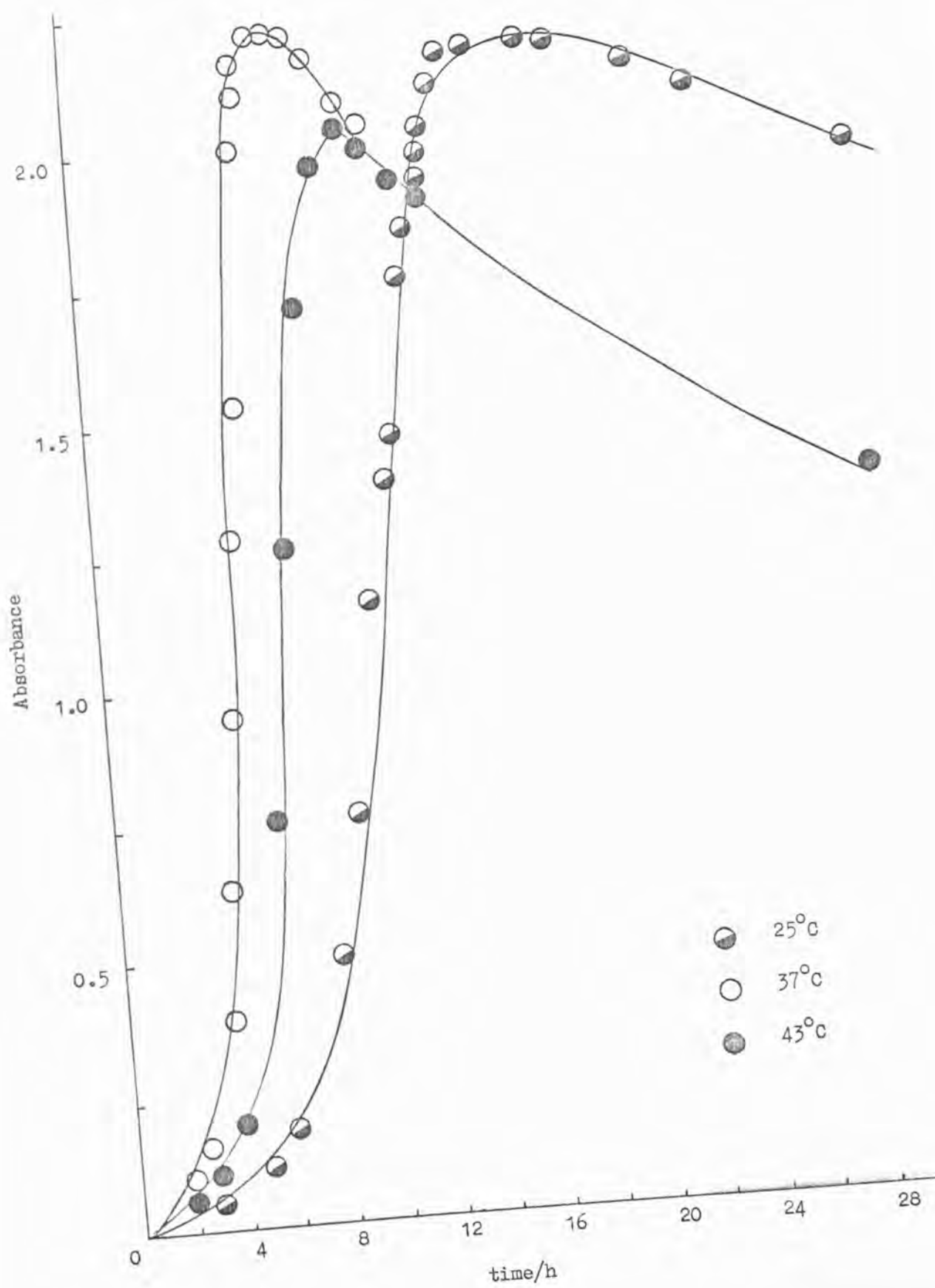

MIC values of cells grown in broth were similar to those obtained at 37°C. The MIC values of all strains grown at 43°C tended to decrease. Cells of gentamicin-resistant strains 100, 104 and Smith had a 2, 8 and 32 fold reduction respectively in MIC, this resulted in cells of strain Smith becoming sensitive to gentamicin. Loss of gentamicin resistance was a temporary phenomenon since cells grown at 43°C, when subsequently inoculated at lower temperatures had MIC values similar to those of the parent strain at 37°C.

The MIC values of cells grown on agar (Table 3.3,) were significantly increased compared with those of cells grown in broth. Cells of strain 1 were still gentamicin-sensitive, but at 37°C the MIC had increased 10 fold. Cells of Smith showed a 5, 20 and 160 fold increase in MIC at 25, 37 and 43°C respectively compared with cells grown in broth, although these cells grown at 43°C on agar were less resistant than when grown at lower temperatures.

Agar-grown cells had a higher MIC than broth-grown cells. Cells of these agar-grown cultures, when grown in broth, exhibited a reduction in MIC to that of the control cells in broth. This indicates that these changes in MIC are not due to genetic factors.

### 3.2. The Effect of Growth Temperature and Nature of the Growth Medium on the pH-Mobility Curves of Cells of *P. aeruginosa*

The pH-mobility curves of gentamicin-sensitive and-resistant strains were determined from cells grown at 25, 37 and 43°C on agar and in broth after subculture from the parent at 37°C in the required medium (2.2.7). Mobility measurements were undertaken

Table 3.2.

MIC of gentamicin for strains of *P. aeruginosa*grown in broth

Strain	Growth Temp/°C	MIC/ $\mu\text{g cm}^{-3}$ measured at		
		25°C	37°C	43°C
1	25	0.2	0.2	0.1
	37	0.2	0.2	0.1
	43	0.2	0.2	0.1
100	25	8000	8000	4000
	37	8000	8000	4000
	43	8000	8000	2000
104	25	1250	2500	625
	37	2500	5000	625
	43	1250	5000	1250
Smith	25	50	12.5	0.78
	37	50	25	0.78
	43	25	25	0.4

Table 3.3.

MIC of gentamicin for strains of *P. aeruginosa*grown on agar

Strain	Growth Temp/°C	MIC/ $\mu\text{g cm}^{-3}$ measured at		
		25°C	37°C	43°C
1	37	-	2	-
Smith	37	256	512	64

at 10°C to suppress motility due to the presence of a single polar flagellum, and in the pH range of 3-10 to avoid changes in surface properties due to denaturation at high or low pH values (Pechey, 1973).

Cells grown on agar at different temperatures when measured at pH 7, and occasionally pH 6 did not always have homogeneous electrokinetic properties (Fig. 3.2). The reproducibility of the mobility measurements of broth-grown cells was not as consistent as that of agar-grown cells. In liquid media the bacteria are continuously subjected to the presence of toxins which could affect the cell surface properties, although subsequent washing of the cells produced a reproducible cell surface.

Cells of gentamicin-sensitive and -resistant strains of P. aeruginosa grown at 37°C had characteristic, but differently shaped pH-mobility curves (Pechey and James, 1974; Chapman, 1976). Cells of the gentamicin-sensitive strain 1 grown in broth exhibited a wave-shaped (SN) pH-mobility curve. An increase in mobility to a maximum in the pH range of 5-6 was followed by a decrease to a minimum between pH 8-9 (Fig. 3.3). The mobility increased as the growth temperature was raised; although the shape of the pH-mobility curves were similar. The wave-shaped pH-mobility curve does not represent a simple pH-titration of the surface ionogenic groups, but indicates that the surface properties of gentamicin-sensitive cells are complex.

The pH-mobility curves of gentamicin-resistant cells, designated as R-shaped, were unlike those of gentamicin-sensitive cells. The mobility increased with increase in pH usually attaining a plateau value, but in some cases the negative mobility decreased at higher pH values. Strains 100 and 104 with high-level resistance

FIGURE 3.2. Histogram of the mobility values at pH 7 of cells of *P. aeruginosa* strain 100 grown on nutrient agar (A3)

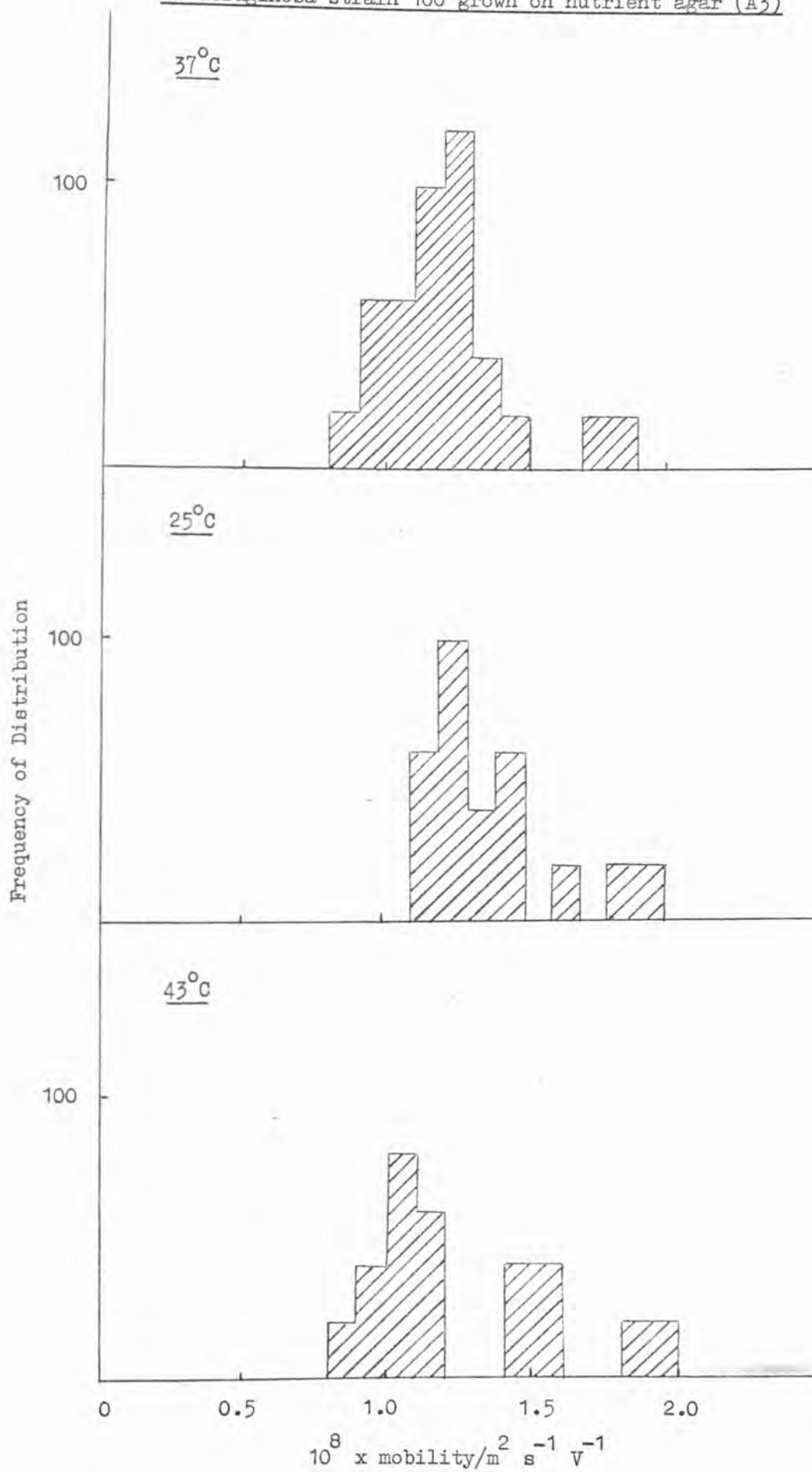

to gentamicin when grown in broth did not exhibit significant differences in the shape or position of the pH-mobility curves with changes in growth temperature (Figs. 3.4, 3.5). The mobility increased to a high plateau value at pH 6; no minimum mobility value was observed at higher pH values. Cells of strain Smith with low-level gentamicin resistance, when grown at 25 and 37°C in broth, exhibited R-shaped pH-mobility curves with a large increase in mobility to a plateau at pH 6. At 43°C a minimum mobility value was observed at pH 7 and the shape of the curve was more characteristic of a gentamicin-sensitive strain. The mobility values at 25°C were less than those at 37 and 43°C (Fig 3.6).

Cells of strain 1 grown on agar at 25, 37 and 43°C again exhibited wave-shaped (SN) pH-mobility curves with maxima at pH 5-6 and minima at pH 8-9. The difference between the maximum and minimum was similar at each growth temperature; thus there was no significant difference between the shape and position of the pH-mobility curves of strain 1 grown at different temperatures on agar, in contrast to cells grown in broth. However, the mobility values of cells grown on agar at all temperatures, and measured in the pH range 5-9 were significantly less than those of cells grown in broth (Fig. 3.3); but at 25°C, at high and low pH values the difference in the mobility between cells grown on agar and in broth was negligible.

Cells of the resistant strains 100 and 104 grown on agar again exhibited typical gentamicin-resistant R-shaped curves (Fig. 3.4, 3.5) with an increase in negative mobility value to a maximum at pH 5.5. There was no significant difference between the shape and position of the curves obtained at different growth temperatures. The pH-mobility curves for cells of Smith grown on agar at 25 and 37°C (Fig. 3.6)

FIGURES 3.3., 3.4., 3.5., 3.6. pH-mobility curves of cells of *P. aeruginosa*  
grown on agar and in broth at 25, 37 and 43°C



25°C, nutrient broth (B1)



37°C, nutrient broth (B1)



43°C, nutrient broth (B1)



25°C, nutrient agar (A3)



37°C, nutrient agar (A3)



43°C, nutrient agar (A3)





FIGURE 3.4. pH-mobility curves of cells of *P. aeruginosa* strain 100

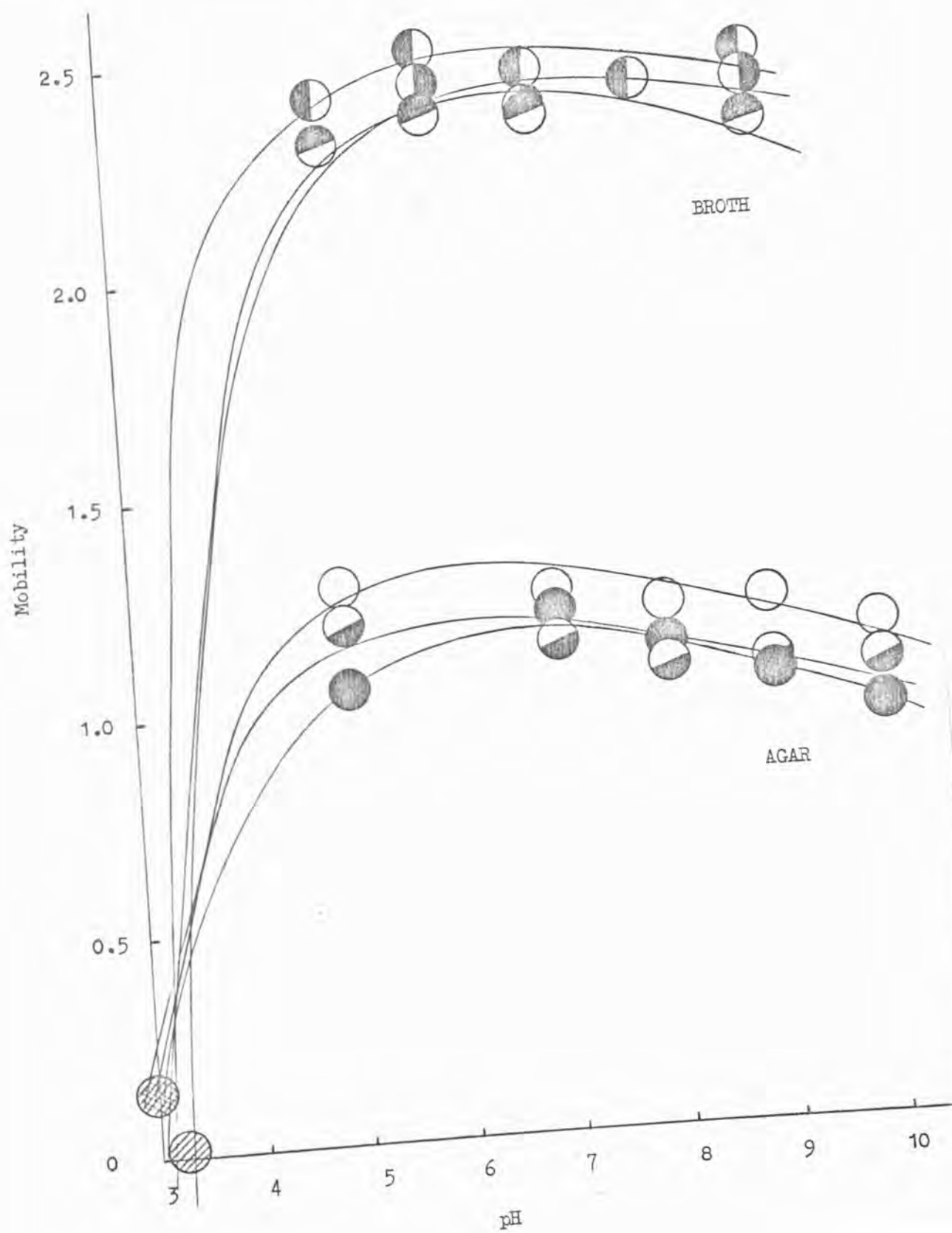

FIGURE 3.5. pH-mobility curves of cells of *P. aeruginosa* strain 104

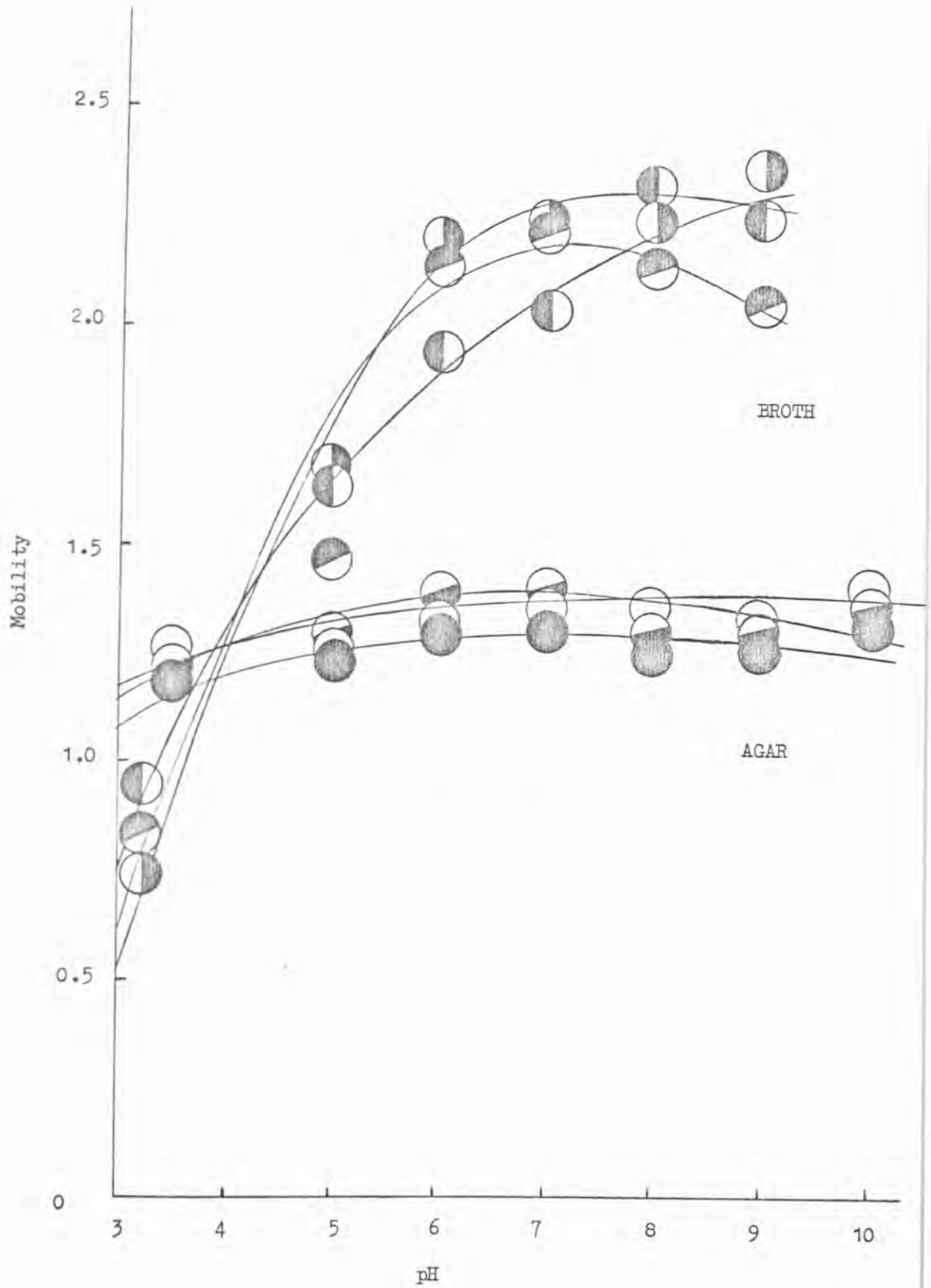
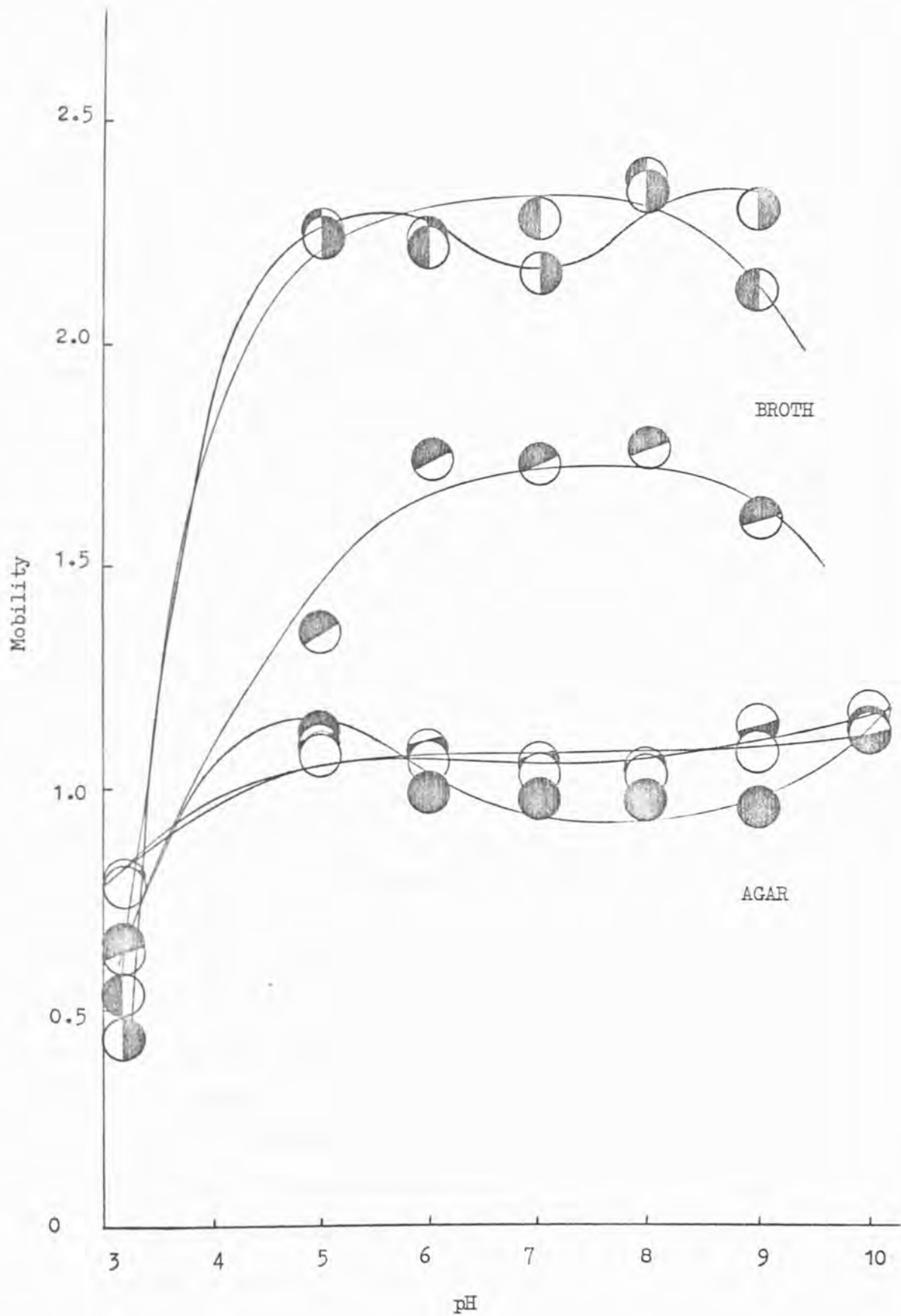

FIGURE 3.6. pH-mobility curves of cells of *P. aeruginosa* strain Smith



were R-shaped, characteristic of a gentamicin-resistant strain; at 43°C the pH-mobility curve became wave-shaped (SN) characteristic of a gentamicin-sensitive strain, this could be correlated with changes in the MIC values of these cells grown at 43°C.

The mobility values of cells of resistant strains grown on agar at all temperatures were significantly less than those for cells grown in broth. Under all experimental conditions the mobility values of all strains were negative.

### 3.3. The effect of Growth Temperature and Nature of the Growth Medium on the Surface Lipid of Cells of *P. aeruginosa*

A quantitative measurement of the amount of lipid present on the surface of bacterial cells can be carried out by electrophoresis, using the method of Dyar (1948) (1.9). Marshall (1969) defined the S-value of cells of *Staph. aureus* as the fractional increase in the mobility of cells suspended in barbiturate-acetate buffer solution (0.02 mol dm<sup>-3</sup>) at pH 7 containing SDS (0.0001 mol dm<sup>-3</sup>) compared with the control cells. From the measurement of SDS treated cells relative to control cells in the absence of SDS a measure of the surface lipid content of cells can be obtained;

$$S = \frac{(\bar{v}_{\text{SDS}} - \bar{v}) \times 100}{\bar{v}}$$

where  $\bar{v}_{\text{SDS}}$  is the mobility value in the presence of SDS and  $\bar{v}$  is that of the control cells in buffer solution alone. In the present work the same definition of S is used for the measurement of surface lipid on cells of *P. aeruginosa* with the exception that the ionic strength of the barbiturate-acetate buffer solution used was 0.005 mol dm<sup>-3</sup>. The mobility values of cells suspended in the presence or absence of SDS were determined (2.2.9) and the S-value calculated. At the SDS concentrations used no denaturation or irreversible changes

to the cell surface were observed (Pechey, 1973). The S-value of a strain of P. aeruginosa has previously been correlated with its MIC. All strains of P. aeruginosa which are sensitive to gentamicin have S-values less than 10; all strains resistant to gentamicin have S-values greater than 10, suggesting a direct correlation between the amount of surface lipid and the degree of gentamicin resistance. The results obtained are tabulated in Table 3.4.

Cells of gentamicin-sensitive strain 1 had low S-values when grown on agar at each growth temperature. The S-values of cells of the gentamicin-resistant strain 100 grown on agar were greater than 10 at 25, 37 and 43°C indicative of a gentamicin-resistant strain. However, there was no evidence of significant amounts of surface lipid when cells of strains 100 and 104 were grown in broth at 25, 37 or 43°C or when cells of strain 104 were grown on agar at 25 and 37°C, although these cells were still gentamicin-resistant. Chapman (1976) found that certain strains, including strain 100, had considerably lower S-values than previously reported (Pechey et al., 1974); an S-value of 17 as opposed to 67 was recorded for strain 100 at 37°C. It is possible that there have been changes in the surface lipid content of cells of strains 100 and 104 as a result of storage and cultivation over the years. This was confirmed by the results of a similar study after a further 6 months; the amount of surface lipid was negligible. These changes were not accompanied by changes in resistance (as determined by the MIC).

The S-values of Smith were significant after growth on agar and in broth at 25 and 37°C, but negligible at 43°C. Little difference was observed between these S-values and those of Smith grown on agar after a 6 month interval, in contrast to strain 100.

Table 3.4.

Surface lipid content of cells of *P. aeruginosa* grown in broth or on agar

Growth medium	Time interval/ months	Growth Temp/°C	S-value			Smith
			1	100	104	
A3	0*	25	2	14	<1	25
		37	6	20	<1	15
	43	1	19	12	<1	<1
A3	6**	25	-	<1	3	28
		37	-	<1	7	17
		43	-	<1	11	<1
B1	-	25	-	<1	4	18
		37	-	<1	<1	26
		43	-	<1	2	<1

<1 : negligible surface lipid recorded

\* : cells measured immediately after growth

\*\* : cells measured after 6 month interval

Changes in the surface lipid content did not correlate with changes in the gentamicin resistance properties of strains 100 and 104, in contrast to Smith (cf. MIC values, Table 3.2, 3.3).

#### 3.4. Summary

1. Cells of the gentamicin-sensitive strain exhibited low MIC values, wave-shaped pH-mobility curves and small amounts of surface lipid when grown in broth or on agar at 25, 37 and 43°C.
2. Cells of the gentamicin-resistant strains which had high MIC values exhibited pH-mobility curves typical of gentamicin-resistant strains; surface lipid was not always detectable.
3. Cells of the low-level gentamicin-resistant strain had MIC values, pH-mobility curves and surface lipid typical of gentamicin-resistant cells when grown on agar or in broth at 25 and 37°C. However, after growth at 43°C on both media the MIC values were markedly decreased (indicating a sensitive strain in broth); the pH-mobility curves were wave-shaped and surface lipid was not detected.
4. Cells grown at 43°C had lower MIC values than those of cells grown at 25 or 37°C. This change in MIC was not permanent since the MIC values of cells subsequently grown at lower temperatures were increased to those of the control cells.
5. Cells grown on agar at all temperatures had higher MIC values and lower mobility values (less negatively charged) than cells grown in broth.

CHAPTER FOUR

THE SURFACE AND BIOLOGICAL PROPERTIES OF CELLS

OF P. AERUGINOSA AFTER REPEATED SUBCULTURE

ON GENTAMICIN-FREE MEDIUM



Over the years it has been observed (Chapman, 1976) that the MIC values for strains with medium- or low-level resistance to gentamicin (MIC 12-100  $\mu\text{g cm}^{-3}$ ) had decreased and the strains had become sensitive to gentamicin. These strains were also shown to possess low amounts of surface lipid and pH-mobility curves characteristic of a gentamicin-sensitive strain. This phenomenon could possibly be the result of regular subculture of the parent strain onto fresh nutrient agar slopes at 37°C. No such trend has been observed for cells of P. aeruginosa possessing high levels of resistance to gentamicin.

A study of the effect of repeated subculture on MIC and surface properties of P. aeruginosa strains with high and low levels of resistance to gentamicin and a sensitive strain was therefore undertaken. Repeated subculture (2.2.4) was carried out at 25, 37 and 43°C. In this way it was also possible to monitor the effect of temperature.

Repeated subculture experiments carried out on a calcium-sufficient medium (Chapman, 1976) did not permanently alter the level of resistance to gentamicin; these subcultured cells when grown in broth had MIC values similar to those of the parent cells grown in broth. Thus, in the present work repeated subculture experiments were carried out on nutrient agar (A3). After 20 or 50 subcultures at 25, 37 and 43°C the cells were grown once more at the appropriate temperature either in broth (B1) or on agar (A3). 18h cells from these cultures were used as inocula for MIC, pH-mobility and surface lipid determinations at 25, 37 and 43°C in broth or on agar.

#### 4.1. The Effect of Growth Temperature and Nature of the Growth Medium on the MIC of Cells of P. aeruginosa

Cells of the gentamicin-sensitive strain 1 showed no change in their MIC values when measured in broth at 37°C after repeated growth at

25 or 37°C (Table 4.1). The MIC was, however, lower (8 fold) when cells repeatedly grown at 43°C were subsequently measured at 37°C; this suggests that some change has occurred in these cells as a result of repeated subculture at 43°C. However, this reduction in MIC at 43°C did not correlate with changes in the pH-mobility curve or surface lipid content.

After twenty subcultures at 25, 37 and 43°C cells of strains 100 and 104 grown in broth at these temperatures were still very resistant to gentamicin (Table 4.1); the values were comparable to those reported previously (Table 3.2). The lower MIC values obtained at 43°C were increased to those of the control cells when the cells were regrown at lower temperatures. After a further 30 subcultures the MIC values of cells of strains 100 and 104 at 43°C, and of strain 104 at 25°C were significantly reduced (Table 4.2); however these changes could not be correlated with changes in the pH-mobility curve or surface lipid content. No significant change in the MIC of cells repeatedly subcultured at 37°C was observed. Although a decreased level of resistance was observed as a result of growth at 25 and 43°C, when cells of these cultures were grown at 37°C the MIC values increased to those of the parent cells at 37°C; thus there is no permanent change in the high-level gentamicin resistance properties of these cells as a result of repeated subculture.

The MIC values of cells of strain Smith grown in broth after repeated subculture on agar at 25, 37 and 43°C were similar to those obtained prior to repeated subculture. The cells were resistant, borderline between sensitive and resistant, and sensitive at 25, 37 and 43°C respectively. Although growth at 43°C produced cells which were very sensitive to gentamicin, repeated subculture at this elevated

Table 4.1.

MIC of gentamicin for strains of *P. aeruginosa* grown in broth after  
20 subcultures on agar

Strain	Temp/°C of RSC	MIC/ $\mu\text{g cm}^{-3}$ measured at		
		25°C	37°C	43°C
1	25	-	0.2	-
	37	-	0.2	-
	43	-	0.02	-
100	25	8000	8000	2000
	37	16000	8000	2000
	43	8000	8000	2000
104	25	2500	1250	625
	37	5000	2500	1250
	43	5000	2500	2500
Smith	25	50	12.5	0.4
	37	12.5	12.5	0.4
	43	25	12.5	0.4

Table 4.2.

MIC of gentamicin for strains of P. aeruginosa grown in broth after  
50 subcultures on agar

Strain	Temp/°C of RSC	<u>MIC/ <math>\mu\text{g cm}^{-3}</math> measured at</u>		
		25°C	37°C	43°C
100	25	8000	8000	250
	37	16000	16000	1000
	43	16000	16000	125
104	25	625	1250	312
	37	5000	5000	1250
	43	312	1250	156

Table 4.3.

MIC of gentamicin in broth and on agar for strain Smith  
after 20 subcultures on agar

Growth medium	<u>MIC/ <math>\mu\text{g cm}^{-3}</math> measured at</u>		
	25°C	37°C	43°C
B1	50	12.5	0.4
A3	512	512	128

temperature did not cause any permanent change in resistance, since when these cells were grown at lower temperatures the MIC was similar to that of the control cells measured prior to repeated subculture.

After 20 subcultures at 25, 37 and 43°C the gentamicin resistance properties of cells of Smith measured on agar at these temperatures were significantly increased (Table 4.3). The MIC values were similar to those measured on agar prior to repeated subculture. Cells of Smith showed a 10, 40 and 320 fold increase in MIC at 25, 37 and 43°C respectively compared with cells grown in broth. Cells grown on agar at 43°C became gentamicin-resistant although the MIC was significantly less than that of cells grown on agar at lower temperatures.

#### 4.2. The Effect of Growth Temperature and Nature of the Growth Medium on the pH-Mobility Curves of Cells of *P. aeruginosa*

16h cells of *P. aeruginosa* were harvested and prepared for electrophoresis. (2.2.7). The pH-mobility curves of *P. aeruginosa* strains were determined in broth and on agar at 25, 37 and 43°C after repeated subculture at these temperatures.

After repeated subculture at 25, 37 and 43°C cells of gentamicin-sensitive strain 1 grown in broth exhibited characteristic wave-shaped (SN) pH-mobility curves (Fig. 4.1) which were not significantly different from those obtained in broth prior to repeated subculture (Fig. 3.3). A rapid increase in mobility towards a maximum at pH 6 was followed by a decrease to a minimum at pH 8-9. As observed with the original control cells the mobility values increased as the growth temperature was raised, thus the shape of the pH-mobility curves was similar but the position varied with growth temperature.

The pH-mobility curves of cells of the gentamicin-resistant strains 100 and 104 grown in broth at 25, 37 and 43°C were characteristic of gentamicin-resistant cells at each temperature (R-shaped). (Figs. 4.2, 4.3). A sharp increase in mobility to a plateau at pH 6-7 was observed. The shape and position of the pH-mobility curves after 20 subcultures were similar to those of the control cells (Figs. 3.4, 3.5) although the mobility values of cells of strain 104 grown at 37°C were slightly lower than those of the control cells grown under the same conditions; this reduced negative charge did not correlate with changes in MIC or surface lipid.

The pH-mobility curves of cells of strain Smith grown in broth at 25 and 37°C were characteristic of gentamicin-resistant cells (Fig. 4.4). The maximum mobility value of the pH-mobility curves obtained at each growth temperature was similar; thus at 25°C this maximum value was greater than that of cells measured at this temperature prior to repeated subculture, although the gentamicin resistance properties of the cells were unaltered. A slightly wave-shaped curve was shown by cells grown at 43°C, this is similar to that shown by the control cells. Since the MIC values of these cells were very low a clearly defined wave-shaped curve was expected. Growth in broth at high temperatures, where the cells are constantly surrounded by toxins and waste materials appears to have a repressive effect on the SN shape of gentamicin-sensitive cells.

Cells of strain 1 repeatedly subcultured on agar at 25, 37 and 43°C exhibited characteristic wave-shaped pH-mobility curves, similar in shape and position to those of cells grown on agar prior to repeated subculture (Fig. 4.1; cf. Fig. 3.3).

FIGURES 4.1., 4.2., 4.3., 4.4. pH-mobility curves of cells of *P. aeruginosa* grown on agar and in broth at 25, 37 and 43°C after 20 subcultures on agar in the absence of gentamicin

 25°C, nutrient broth (B1)

 37°C, nutrient broth (B1)

 43°C, nutrient broth (B1)

 25°C, nutrient agar (A3)

 37°C, nutrient agar (A3)

 43°C, nutrient agar (A3)

FIGURE 4.1. pH-mobility curves of cells of *P. aeruginosa* strain 1  
after repeated subculture

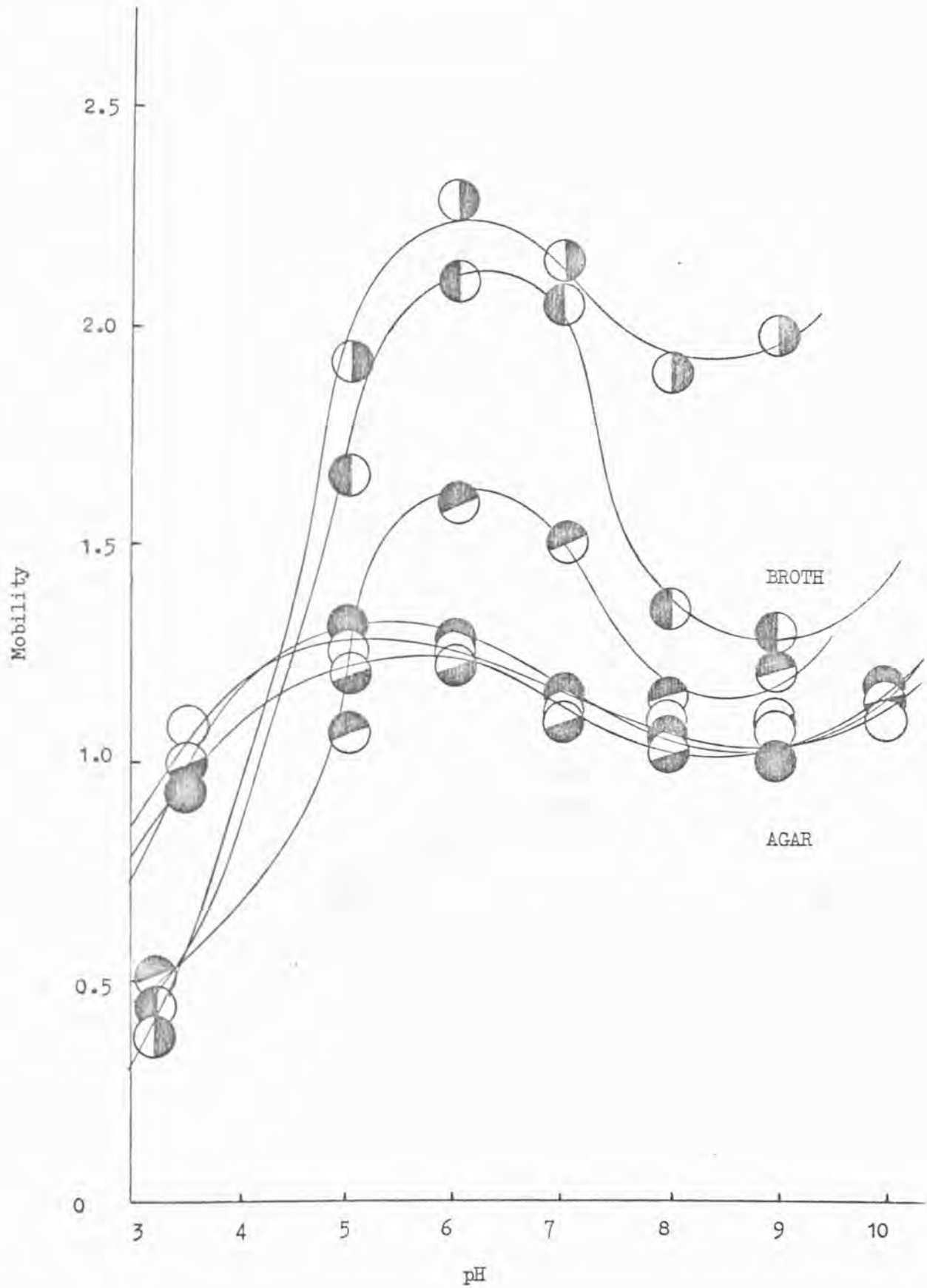



FIGURE 4.2. pH-mobility curves of cells of *P. aeruginosa* strain 100 after repeated subculture

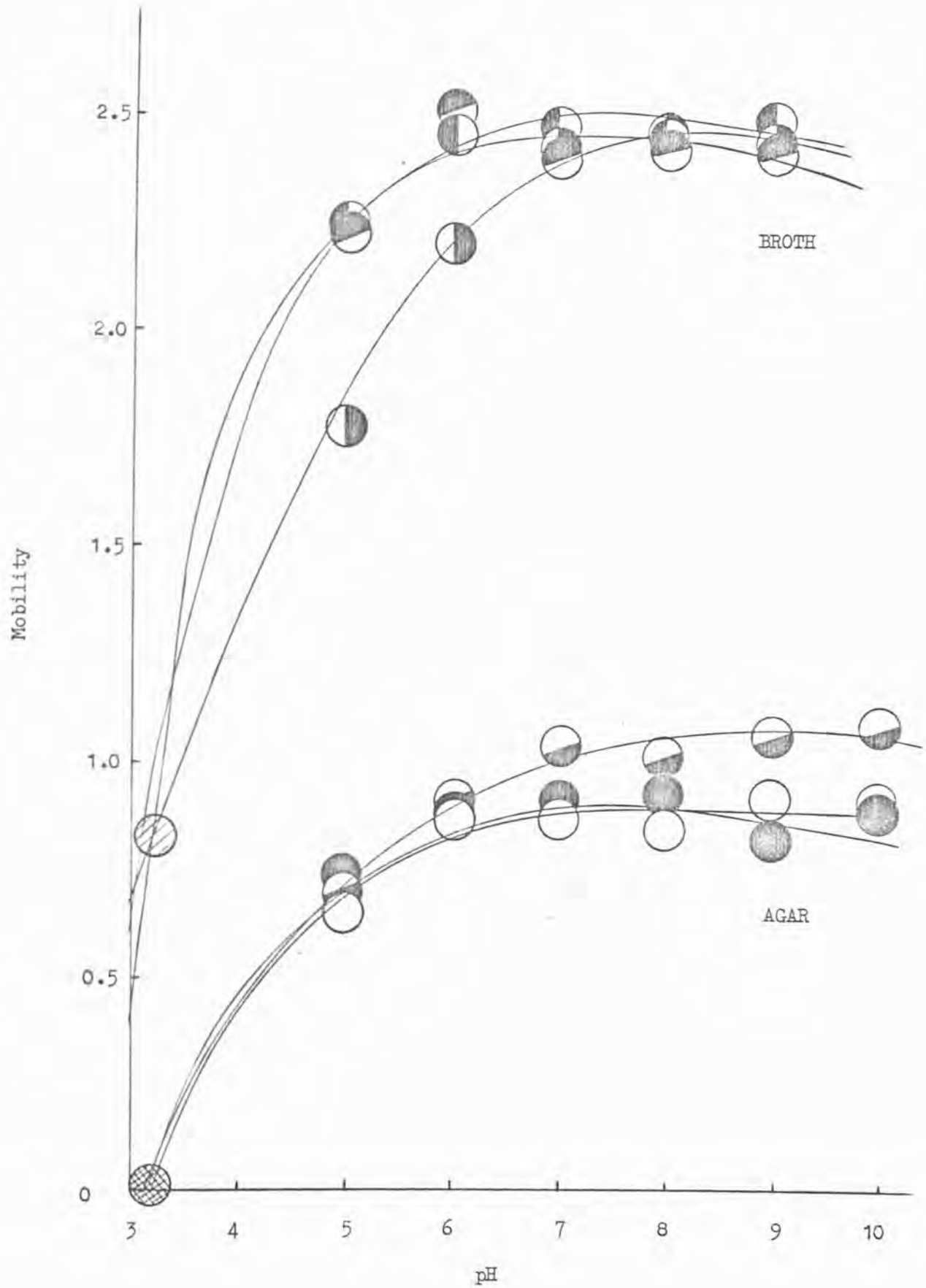

FIGURE 4.3. pH-mobility curves of cells of *P. aeruginosa* strain 104  
after repeated subculture

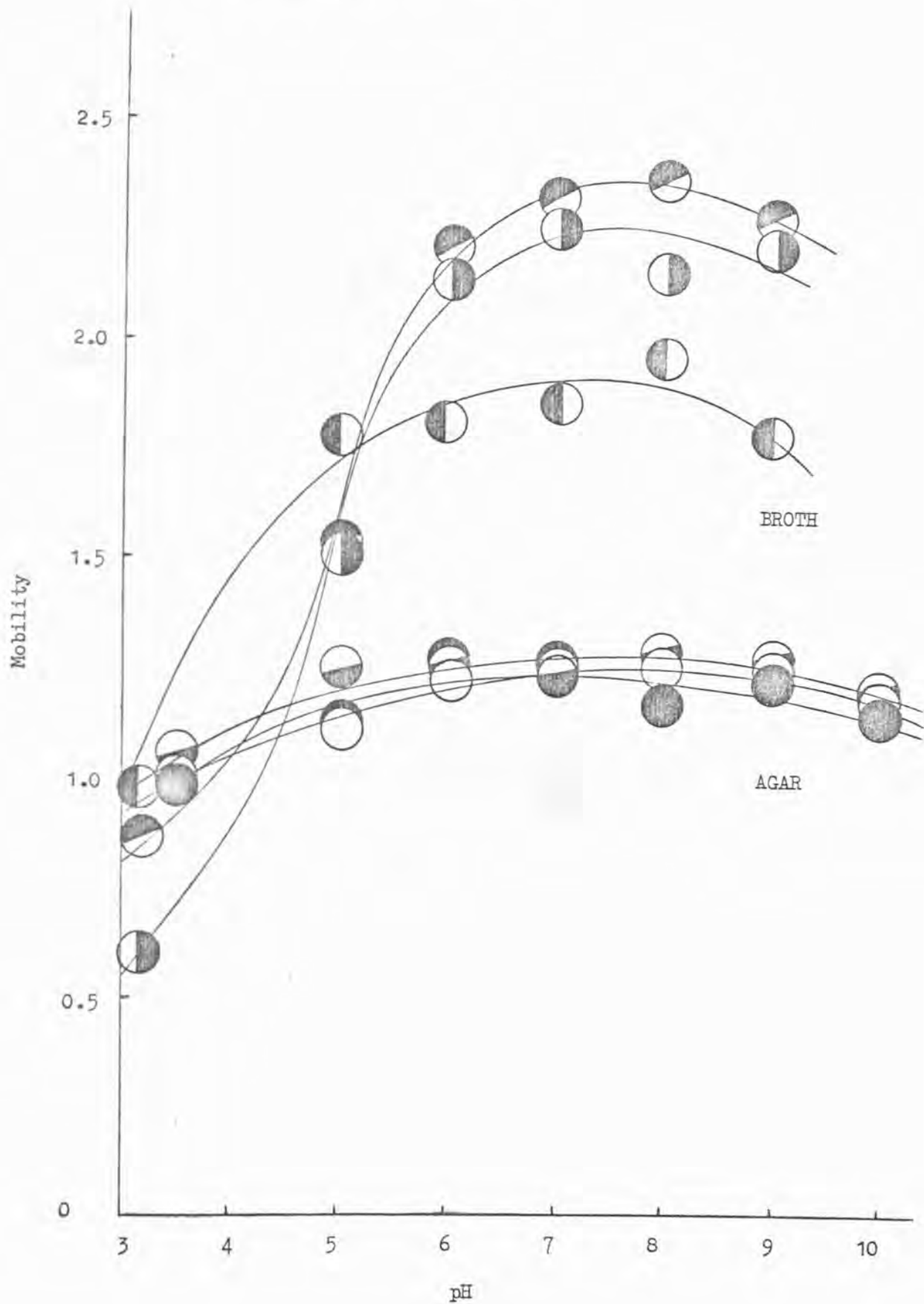
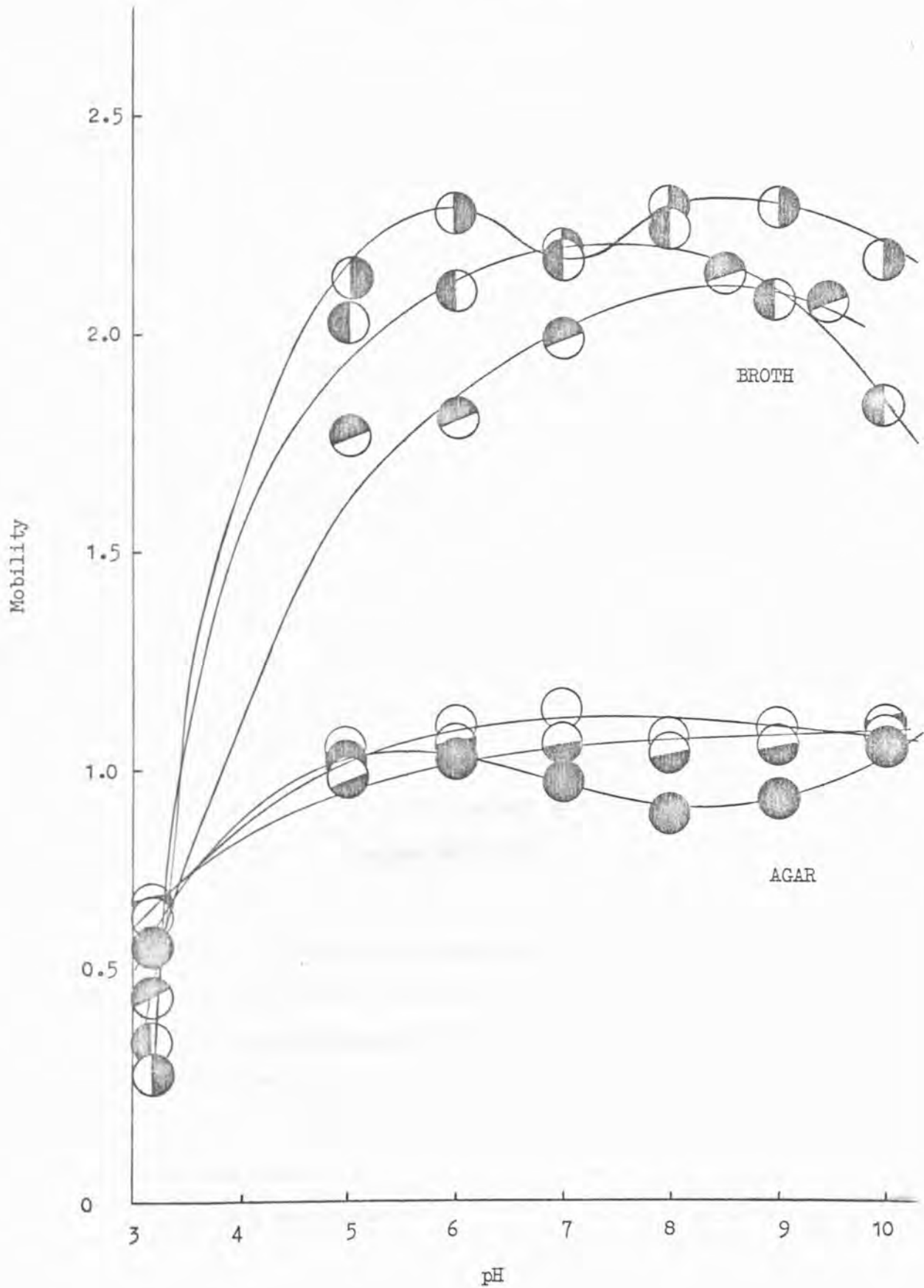

FIGURE 4.4. pH-mobility curves of cells of *P. aeruginosa* strain Smith after repeated subculture



Cells of the gentamicin-resistant strains 100 and 104 grown on agar at 25, 37 and 43°C exhibited R-shaped pH-mobility curves; there was no significant reduction in mobility at high pH values. The shape of the pH-mobility curves of both strains was not significantly altered by changes in the growth temperature. Cells of strain 100 exhibited slightly lower maximum mobility values than the control cells at each temperature, but the mobility values of 104 were not affected. The reduced mobility values of 100 did not correlate with changes in MIC or surface lipid.

The pH-mobility curves of cells of strain Smith grown on agar at 25 and 37°C were R-shaped (Fig. 4.4). A plateau mobility value was reached at pH 6; there was no decline in mobility at high pH values. After repeated subculture at 43°C a slightly wave-shaped pH-mobility curve was obtained, with a maximum mobility at pH 5-6 and a minimum at pH 8-9. The shape and position of each curve were similar to those of cells measured on agar prior to subculture. (Fig. 3.6).

The negative mobility values of cells of both resistant and sensitive strains grown on agar were markedly lower than those of cells grown in broth; this phenomenon was also observed with the control cells before repeated subculture.

#### 4.3. The Effect of Growth Temperature and Nature of the Growth Medium on the Surface Lipid of Cells of *P. aeruginosa*

Cells of *P. aeruginosa* subcultured 20 times on agar at 25, 37 and 43°C were grown once on agar and these cells used as inoculum for surface lipid measurements at 25, 37 and 43°C. Surface lipid was measured immediately after repeated subculture, and again after a 6 month interval; during this time the strains

were stored at 4°C on agar, and subcultured bimonthly. 18h cells were harvested and the S-values measured (Table 4.4).

The S-values of cells of strain 1 grown on agar at 25, 37 and 43°C were less than 10 and similar to the S-values prior to subculture; these values are characteristic of a gentamicin-sensitive strain.

Cells of the resistant strains 100 and 104 had S-values greater than 10 when grown at each temperature after repeated subculture indicative of significant surface lipid; thus cells of strain 100 had a greater proportion of surface lipid after subculture at 25 and 43°C and the S-values of cells of 104 repeatedly subcultured at 25, 37 and 43°C had become significant, in contrast to the control cells of these strains (Table 3.4). Cells of strain Smith had S-values greater than 10 after 20 subcultures at 25 and 37°C, but negligible S-values at 43°C; this change in surface lipid at 43°C corresponded with the change in MIC and shape of the pH-mobility curve.

After a further 6 month storage cells of strain 100 still possessed significant surface lipid when grown on agar at 25°C, but low and negligible S-values were obtained after growth at 37 and 43°C respectively. Cells of 104 had low or negligible S-values at each growth temperature; surface lipid was no longer detectable. In cells grown at 25 and 37°C, however, the MIC values were unaltered from those measured after repeated subculture. Thus the surface lipid content of strains 100 and 104 varied but their intrinsic mechanism of resistance to gentamicin was unaffected.

Table 4.4.

Surface lipid content of cells of *P. aeruginosa* grown on agar  
after repeated subculture on agar.

Growth medium	Time interval/ months	Repeated growth at temp/° C	S-value			
			1	100	104	Smith
A3	0*	25	4	33	20	13
		37	6	22	15	11
		43	3	63	13	<1
A3	6**	25	-	40	<1	-
		37	-	6	<1	-
		43	-	<1	6	-

<1 : negligible surface lipid recorded

\* : cells measured immediately after growth

\*\* : cells measured after a 6 month interval

#### 4.4. Summary

1. After 20 subcultures of the gentamicin-sensitive strain at 25, 37 and 43°C on agar the cells exhibited wave-shaped pH-mobility curves, low MIC values and low surface lipid content when finally grown in broth or on agar at each temperature.

2. Repeated subculture of cells with high-level gentamicin resistance produced cells which exhibited high MIC values and characteristic R-shaped pH-mobility curves, surface lipid was detectable. After a 6 month interval these cells had negligible surface lipid.

3. Repeated subculture of cells of the low-level gentamicin-resistant strain produced cells with MIC values, pH-mobility curves and surface lipid indicative of a gentamicin-resistant strain after growth at 25 and 37°C in broth and on agar. At 43°C significant reductions in MIC values were observed and the cells exhibited wave-shaped pH-mobility curves and had negligible S-values.

4. After repeated subculture all cells had reduced MIC values at 43°C which resulted in one strain becoming gentamicin-sensitive in broth.

5. Cells of all strains grown on agar had increased MIC and decreased mobility values.

6. In general, the results determined after repeated subculture were similar to those of cells measured prior to repeated subculture.

CHAPTER FIVE

THE SURFACE AND BIOLOGICAL PROPERTIES

OF R-FACTOR STRAINS OF P. AERUGINOSA



Strains of P. aeruginosa possessing inactivating enzymes (R-factors), which are mediated by extrachromosomal deoxyribonucleic acid (DNA) are capable of transferring resistance by conjugation to gentamicin-sensitive cells thereby rendering them gentamicin-resistant (Benveniste and Davies, 1971 a,b; Roe et al., 1971).

R-factor strains contain negligible surface lipid and exhibit gentamicin-sensitive type pH-mobility curves at 37°C (Chapman, 1976); gentamicin-sensitive acceptor strains, on the acquisition of R-factors, still exhibit a pH-mobility curve characteristic of a gentamicin-sensitive strain. However, cells of the R-factor strain PL11 exhibit gentamicin-resistant type pH-mobility curves and have high surface lipid. Thus strain PL11 also carries an alternative, possibly a barrier-type, mechanism of resistance.

The resistance properties of methicillin-resistant strains of the Gram-positive organism Staph. aureus altered with changes in growth temperature. This methicillin resistance, which was located on a plasmid, was lost after repeated subculture at high temperatures in the absence of the antibiotic (Al-Salihi, 1975).

The following experiments were undertaken to determine whether changes in the growth temperature, growth medium and repeated subculture would result in changes in surface properties and loss of R-factor resistance to gentamicin.

#### 5.1. The Effect of Growth Temperature and Nature of the Growth Medium before Repeated Subculture

Cells of the R-factor strains PL11 and Capetown were grown once on agar or in broth at 37°C for 18h from the parent cells, and cells of these cultures used as an inoculum for the appropriate media. MIC values, pH-mobility curves and surface lipid was

measured on cells grown at 25, 37 and 43°C in nutrient broth (B1) or on nutrient agar (A3).

#### 5.1.1. MIC of Gentamicin

The MIC values of strains PL11 and Capetown were determined in broth and on agar at 25, 37 and 43°C (Table 5.1). At 25 and 37°C both strains measured in broth were gentamicin-resistant. At 43°C there was a large decrease in MIC; these cells were gentamicin-sensitive. However, the MIC values of cells grown at 43°C and tested at 37°C were similar to those of cells grown and tested at 37°C, indicating that growth of cells at 43°C in the presence of gentamicin markedly reduced the MIC.

The MIC values of PL11 and Capetown on agar were greater than when these strains were measured in broth. However, at 43°C on agar the MIC values were still significantly less than those of cells grown at 25 and 37°C, as found with broth-grown cells.

#### 5.1.2. pH-Mobility Curves

Strains Capetown and PL11 were studied to investigate whether the observed changes in MIC with growth temperature could be correlated with changes in surface properties and growth media.

Cells of PL11 grown in broth exhibited characteristic gentamicin-resistant (R-shaped) pH-mobility curves at 25 and 37°C (Fig. 5.1). A maximum mobility value was reached at pH 7 followed by a decline to a lower negative mobility at higher pH values. Cells grown at 43°C, however, exhibited wave-shaped (SN) pH-mobility curves more characteristic of a gentamicin-sensitive strain, with a maximum at pH 6 and a minimum at pH 9; this correlated with the low MIC obtained at this temperature in broth (see Table 5.1). Cells of Capetown exhibited wave-shaped pH-mobility curves (Fig. 5.2) when grown in broth at 37 and 43°C; however, at 25°C the pH-mobility curve was more characteristic of a gentamicin-resistant strain.

Table 5.1.

The MIC of R-factor strains of P. aeruginosa grown in broth and on agar

Strain	Growth medium	Growth temp/°C	MIC/ $\mu\text{g cm}^{-3}$ measured at		
			25°C	37°C	43°C
PL11	B1	37	200	100	6.25
		43	-	50	-
Capetown	B1	37	200	100	3.12
		43	-	100	-
PL11	A3	37	512	512	64
Capetown	A3	37	256	512	64

Table 5.2.

The surface lipid content of cells of the R-factor strain PL11  
grown in broth and on agar

Strain	Growth temp/°C	S-value/cells grown on	
		agar	broth
PL11	25	14	13
	37	11	10
	43	4	<1

FIGURES 5.1., 5.2., 5.3. pH-mobility curves of cells of R-factor strains  
of *P. aeruginosa* grown on agar and in broth at 25,  
37 and 43°C before and after twenty subcultures in  
the absence of gentamicin.

 25°C, nutrient broth (B1)

 37°C, nutrient broth (B1)

 43°C, nutrient broth (B1)

 25°C, nutrient agar (A3)

 37°C, nutrient agar (A3)

 43°C, nutrient agar (A3)

FIGURE 5.1. pH-mobility curves of cells of *P. aeruginosa* strain PLII

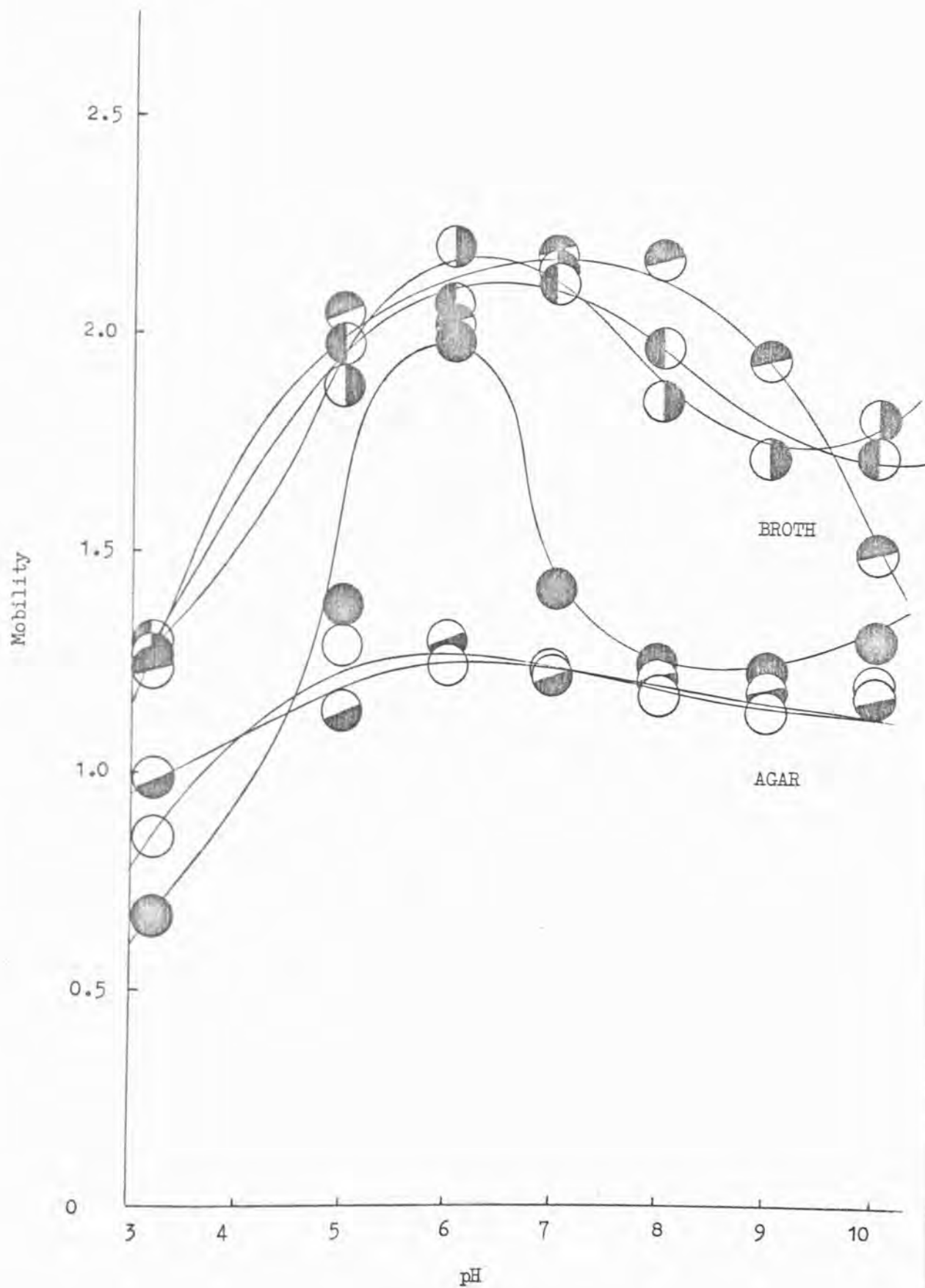
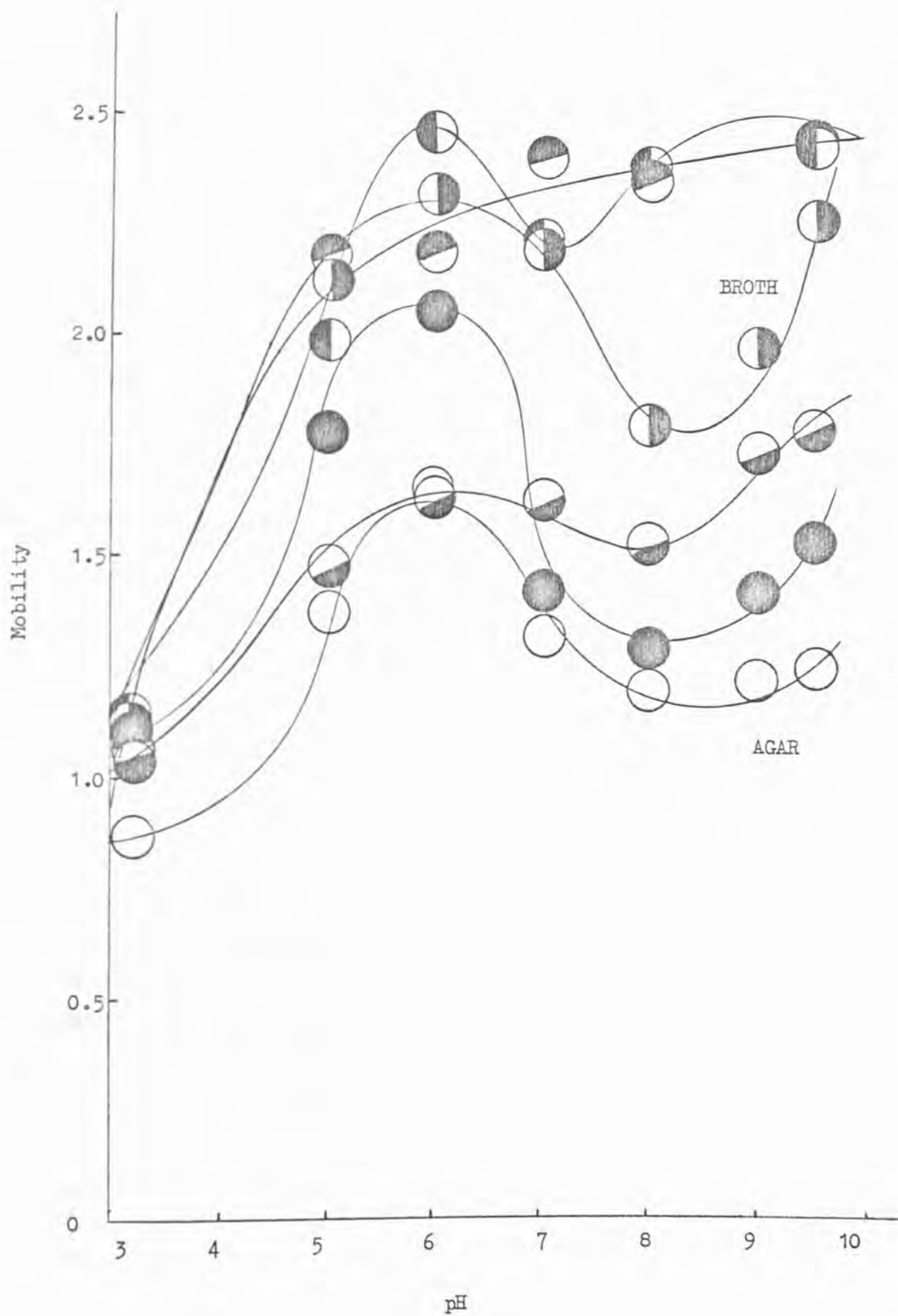

FIGURE 5.2. pH-mobility curves of cells of *P. aeruginosa* strain Capetown



Agar-grown cells of PL11 exhibited R-shaped pH-mobility curves at 25 and 37°C (Fig. 5.1), while at 43°C the curve was SN-shaped and characteristic of a gentamicin-sensitive strain. Cells of Capetown grown on agar at 37 and 43°C again exhibited wave-shaped gentamicin-sensitive type pH-mobility curves; however, at 25°C the shape of the pH-mobility curve more resembled the R-shaped curve of resistant cells.

The negative mobility of cells of both strains grown on agar at all temperatures was significantly less than that of cells grown in broth.

### 5.1.3. Surface Lipid

The S-values of cells of PL11 grown either on agar or in broth at 25 and 37°C were in excess of 10 indicating the presence of surface lipid (Table 5.2); at 43°C there was no detectable surface lipid (cf. MIC values, Table 5.1).

The S-values of cells of PL11 grown on agar at each temperature were similar to those of cells grown in broth.

## 5.2. The Effect of Growth Temperature and Nature of the Growth Medium after Repeated Subculture on Gentamicin-Free Agar

Cells of the R-factor strains PL11 and Capetown were subcultured 20 times on agar at 25, 37 and 43°C (2.2.4). These cells were grown once more on agar or in broth at the appropriate temperature, and 18h cells from these cultures used as an inoculum for MIC, pH-mobility and surface lipid determinations on agar and in broth at 25, 37 and 43°C.

### 5.2.1. MIC of Gentamicin

The MIC values of PL11 and Capetown were determined in broth or on agar at 25, 37 and 43°C after repeated subculture (Table 5.3).

The MIC of cells of PL11 and Capetown measured in broth at 25°C after repeated subculture was significant; this indicated that these cells were still gentamicin-resistant. Cells repeatedly subcultured at 43°C were gentamicin-sensitive, but the MIC values of these cells were considerably less than those of cells grown at 43°C prior to subculture. Cells repeatedly subcultured at 37°C had low MIC values indicating these cells were gentamicin-sensitive, in contrast to the control cells. Cells of Capetown and PL11 repeatedly subcultured at 37 and 43°C, then measured at 25 and 37°C were still gentamicin-sensitive. In contrast, cells grown once at 43°C and measured at 37°C were gentamicin-resistant (Table 5.1). This indicates some significant change has occurred as a result of repeated subculture at 37 and 43°C which alters the gentamicin resistance properties of these cells.

Cells of Capetown and PL11 measured on agar at 25, 37 and 43°C after repeated subculture at these temperatures had significantly greater MIC values than those of cells grown in broth, as found with the control cells. Cells grown at 25°C possessed levels of resistance similar to those of the control cells. However, the MIC values of cells grown on agar at 37 and 43°C were lower than the MIC values of the control cells on agar (see Tables 5.1, 5.3) and at 43°C on agar the MIC was approximately  $12 \mu\text{g cm}^{-3}$ .



Table 5.3.

MIC of the R-factor strains of *P. aeruginosa* grown in  
broth and on agar after 20 subcultures on agar

Strain	Growth medium	Temp/°C of RSC*	MIC/ $\mu\text{g cm}^{-3}$ measured at		
			25°C	37°C	43°C
PL11	B1	25	400	200	12.5
		37	<1.56	0.64	<1.56
		43	<1.56	<1.56	<0.16
Capetown	B1	25	100	200	0.78
		37	6.25	6.25	0.78
		43	3.12	1.56	0.78
PL11	A3	25	512	-	-
		37	-	32	-
		43	-	-	8
Capetown	A3	25	512	-	-
		37	-	32	-
		43	-	-	16

\* RSC repeated subculture

Table 5.4.

The surface lipid content of cells of the R-factor strain  
PL11 grown in broth and on agar after 20 subcultures on agar

Strain	Growth Temp/°C	S-value/cells grown on	
		agar	broth
PL11	25	27	13
	37	6	<1
	43	<1	<1

### 5.2.2. pH-Mobility Curves

Cells of PL11 grown in broth after 20 subcultures on agar exhibited gentamicin-resistant (R-shaped) pH-mobility curves at 25°C and wave-shaped curves typical of a gentamicin-sensitive strain at 43°C (Fig. 5.3); these were similar to the control cells (see Fig. 5.1). However, the surface properties of cells measured at 37°C in broth had changed and a wave-shaped gentamicin-sensitive type curve was obtained, in contrast to the gentamicin-resistant pH-mobility curves of the control cells. This change in surface properties correlated with changes in MIC (see Table 5.3).

Gentamicin-resistant (R-shaped) curves were obtained for cells of PL11 grown on agar at 25°C, and gentamicin-sensitive (SN-shaped) curves at 43°C as found for the control cells. (Fig. 5.3; cf. Fig. 5.1). However, at 37°C the surface properties of the cells had changed and the pH-mobility curve had become SN-shaped. Cells grown at 43°C exhibited a more pronounced wave-shaped curve than cells grown at 37°C and the maximum at pH 6 was greater.

The negative mobility values of cells measured after growth on agar were always less than those of cells grown in broth, as found with cells measured prior to subculture experiments.

### 5.2.3. Surface Lipid

Cells of PL11 subcultured 20 times on agar at 25, 37 and 43°C were grown on agar and in broth at these temperatures and the surface lipid content determined (Table 5.4).

The S-values of cells of PL11 grown in broth after repeated subculture were greater than 10 at 25°C and negligible at 43°C; these values were similar to those of the control cells. However, the S-values of cells measured at 37°C were negligible, in contrast to the control cells, suggesting changes in the amount of surface

FIGURE 5.3. pH-mobility curves of cells of *P. aeruginosa* strain PLII  
after repeated subculture

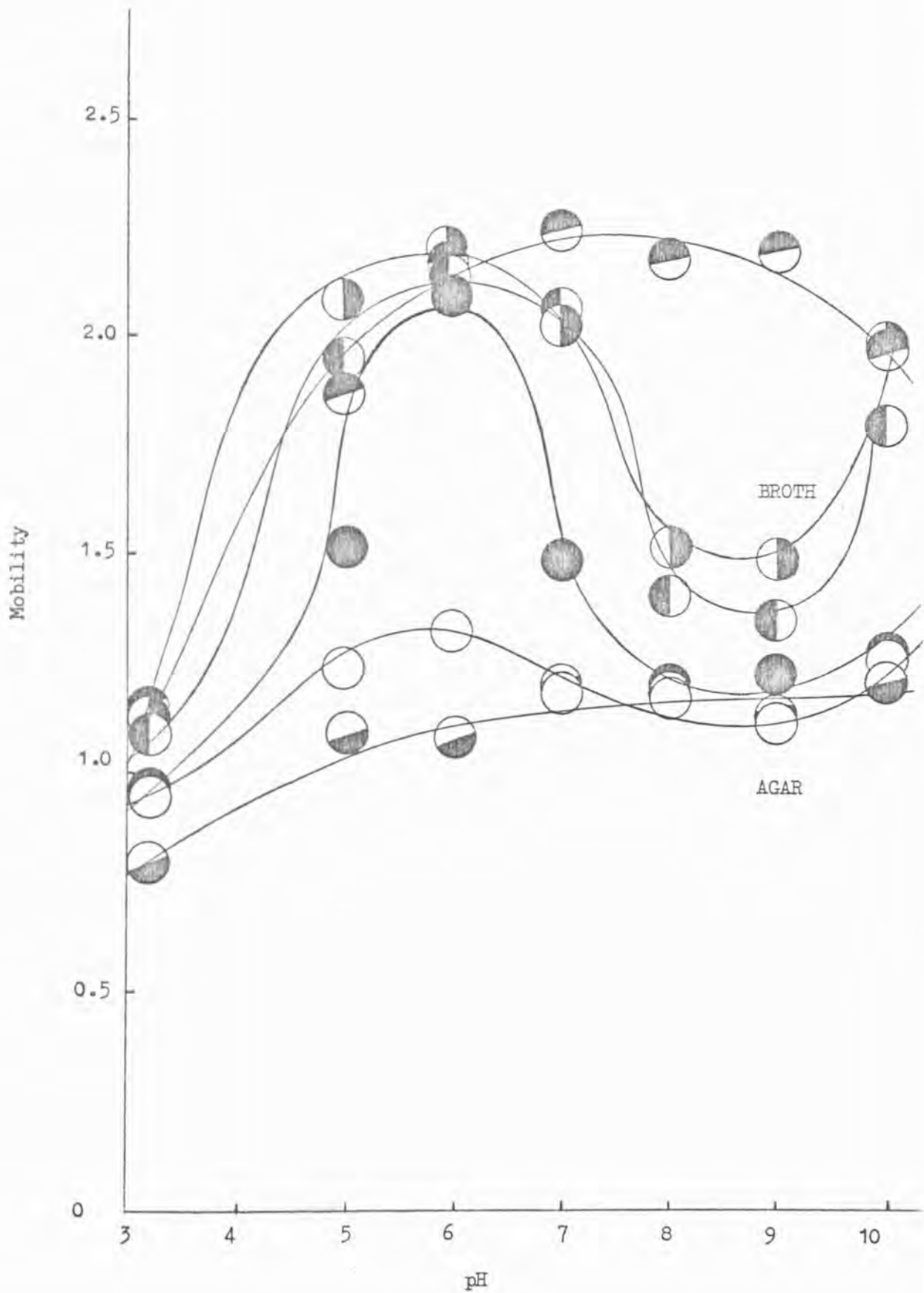

lipid after repeated subculture at 37°C (cf. MIC values, Table 5.3).

The S-values of cells grown on agar at 25°C after repeated subculture were significant. The S-value of agar-grown cells was greater than that of the control cells; this suggested increased gentamicin-resistance. In contrast, a similar increase was not obtained in broth. Negligible S-values were obtained for cells grown on agar at 37 and 43°C. The negligible amounts of surface lipid present in cells which had been repeatedly subcultured at 37°C correlated with the change in shape of the pH-mobility curve and the reduced MIC values of these cells. (See Fig. 5.3, Table 5.3).

### 5.3. The Attempted Transfer of R-Factors

Repeated subculture of cells of P. aeruginosa at 37 and 43°C produced cells which had lost their resistance to gentamicin. Since gentamicin resistance has been attributed to the presence of R-factors, wholly in Capetown, and partly in PL11, attempts were made to produce transconjugants from the parent strains and from cells obtained after repeated subculture of these strains at 25, 37 and 43°C (Sect. 2.2.12).

Cells of exponentially growing cultures of the parent strains Capetown and PL11 grown at 37°C and cells repeatedly subcultured at 25, 37 and 43°C on nutrient agar (A3) were mated with gentamicin-sensitive, rifampicin-resistant acceptor strain FU21 at 37°C in nutrient broth (B1). The cells were subsequently inoculated onto nutrient agar plates (A1) containing gentamicin and rifampicin, incubated for 24h at 37°C and the presence of transconjugants noted (Table 5.5). The resistance of any transconjugants produced was subsequently measured. A1 medium was used in preference to A3 medium for the selection of transconjugants since the acceptor strain became gentamicin-resistant on A3 medium (Table 5.6).

Table 5.5.

Transfer between R-factor donor strains and an acceptor strain

Growth temp/°C	S.C.*	Donor strains		Acceptor	Transconjugants	
		PL11	Capetown	PU21	PU21(RPI11)	PU21 (ρMG1)
37	1	-	-	-	+	+
25	20	-	-	-	++	+
37	20	-	-	-	-	-
43	20	-	-	-	-	-

- : no growth ; + : growth ; ++ : good growth

\* S.C. : number of subcultures

Table 5.6.

MIC of the acceptor strain PU21 at 37°C

Growth media	B1	A1	A3
MIC/ $\mu\text{g cm}^{-3}$	4	8	>40

Table 5.7.

MIC of gentamicin of donor, acceptor and transconjugant

strains grown in broth at 37°C

Strains	Growth Temp/°C	S.C.	MIC/ $\mu\text{g cm}^{-3}$	Transconjugant	MIC/ $\mu\text{g cm}^{-3}$
<u>Donor</u>					
PL11	37	1	100	PU21(RPL11)	400
	25	20	400	PU21(RPL11)(20/25)	400
Capetown	37	1	100	PU21(ρMG1)	50
	25	20	50	PU21(ρMG1)(20/25)	50
<u>Acceptor</u>					
PU21	37	1	4	-	-

(20/25) : donor cells have been subcultured 20 times at 25°C before mating with acceptor strain.

Transconjugants were produced from cells of the control parent strains Capetown and PL11 grown at 37°C and from cells of both strains repeatedly subcultured at 25°C, but transconjugants could not be produced from cells of strains repeatedly subcultured at 37 or 43°C.

Subsequent determinations of the MIC of the transconjugants produced from the donor strain Capetown in broth (B1) at 37°C (Table 5.7) showed that the transconjugants PU21(ρMG1) and PU21 (ρMG1) (20/25) (i.e. subcultured 20 times at 25°C) had MIC values similar to those of the parent donor strain. The MIC of the parent donor cells and the MIC of these cells repeatedly subcultured at 25°C were also similar.

The MIC of the parent strain PL11 grown at 37°C was lower than that of these cells grown at 25°C or after repeated subculture at 25°C. The MIC values of both transconjugants PU21(RPL11) and PU21 (RPL11) (20/25) (i.e. subcultured 20 times at 25°C) were higher than the parent strain measured at 37°C and were similar to those of the parent strain subcultured 20 times at 25°C.

#### 5.4. Summary

1. When cells of the strain possessing resistance due only to the presence of R-factors were grown on agar and in broth at 25 and 37°C before repeated subculture, the MIC values were significant. The pH-mobility curve was wave-shaped (SN) at 37°C, but was more typical of the R-shaped curve of a gentamicin-resistant strain at 25°C. At 43°C the pH-mobility curve was wave-shaped, the MIC was reduced and in broth was characteristic of a gentamicin-sensitive strain.

2. The R-factor strain possessing an additional mechanism of resistance to gentamicin had pH-mobility curves, MIC and S-values characteristic of a gentamicin-resistant strain when grown in broth or on agar at 25 and 37°C. At 43°C the MIC was reduced and had become sensitive in broth; the cells exhibited wave-shaped pH-mobility curves and negligible S-values.

3. After repeated subculture at 25°C the strain possessing two resistance mechanisms was still gentamicin-resistant, with an R-shaped pH-mobility curve, high MIC and S-values. At 43°C gentamicin-sensitive properties were observed; SN-shaped pH-mobility curve, low MIC and S-values. At 37°C, however, the MIC was greatly reduced and the cells had become sensitive in broth; the pH-mobility curve was wave-shaped and surface lipid was negligible, in contrast to the control cells.

4. After repeated subculture at 37 and 43°C both strains had significantly decreased MIC values; cells repeatedly grown at 37°C had become sensitive in broth. When cells of both strains, repeatedly subcultured at 37 and 43°C, were grown at 25°C the MIC was not increased, in contrast to the control cells.

5. The mobility values decreased and the MIC increased when cells of both strains were grown on agar.

6. Transconjugants were obtained from both parent donor strains, and from cells of these strains repeatedly subcultured at 25°C; transconjugants were not produced from cells repeatedly subcultured at 37 and 43°C.

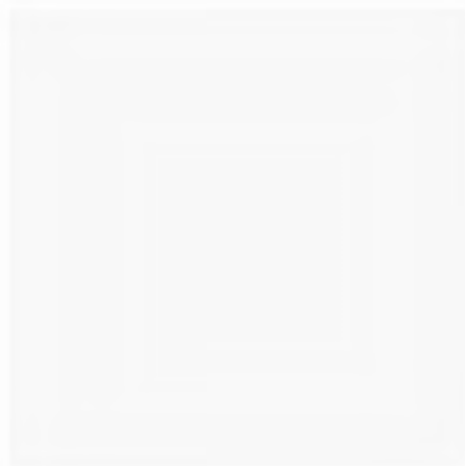

CHAPTER SIX

CHEMICAL ANALYSIS OF CELLS OF P. AERUGINOSA



Strains of P. aeruginosa resistant and sensitive to gentamicin grown on agar exhibited pH-mobility curves similar in shape to those of cells grown in broth. However, agar-grown cells had significantly reduced negative mobility values; the MIC values were also greatly increased. (See Chaps. 3,4,5).

Factors responsible for the decrease in negative mobility value could be a reduction in the synthesis of the groups responsible for the shape of the pH-mobility curve, increased production of certain cell envelope components which associate with or block the ionogenic surface groups, and association of other charged groups, such as divalent metal ions, with the cell surface.

These experiments were undertaken to determine the protein, polysaccharide and divalent metal ion content of cells of P. aeruginosa grown in broth and on agar.

#### 6.1 Analysis of the Protein and Polysaccharide Content of Cells of P. aeruginosa

Cells of P. aeruginosa strains 104, Smith and PL11 were grown on agar or in broth for 18h at 37°C. The cells were harvested, washed, resuspended in saline and dry weights determined (2.3.4.) Protein was estimated by the Biuret method and polysaccharide by the anthrone method (2.3.4.). The results are expressed as percentage dry weight (Table 6.1). Duplicate results were in good agreement for each strain on agar and in broth.

The determination of protein content by the Biuret method gave higher protein results than expected. Discrepancies arose partly due to the cell wall protein being more chromogenic than the bovine serum albumin used as standard (Clarke et al., 1967a,b,c) and partly as a

result of the presence of substances, such as peptidoglycan, which interfere with the Biuret estimation of protein. However, comparisons between the variations in protein content of cells grown in different media remained valid.

Cells of strains Smith and 104 grown on agar had a significantly higher polysaccharide content (approximately 50%) and a significantly lower protein content (36 and 19% respectively) than cells of these strains grown in broth. There was a slight increase in the polysaccharide and protein content of cells of PL11 grown on agar compared with growth in broth (14 and 12% respectively).

Thus growth on agar containing large amounts of divalent metal ions resulted in a significant increase in polysaccharide; in general the protein content was decreased.

## 6.2 Divalent Metal Ion Content of Cells of *P. aeruginosa*

Cells of *P. aeruginosa* strains 1 and 100 were grown at 37°C for 18h on agar (A3), harvested and prepared for metal ion analysis (2.3.2) and the results compared with those of cells grown in broth (B1) carried out under the same conditions (Chapman, 1976). The results (Table 6.3), expressed as percentage dry weight, are the mean of duplicate results.

The concentrations of the divalent metal ions calcium, magnesium, iron (II) and zinc were greater in the agar medium than in broth (Table 6.2); namely 100, 20 and 10 fold for calcium, magnesium and zinc/iron (II) respectively. The calcium content of agar was significantly greater than that of the other metal ions measured.

Table 6.1.

Analysis of the protein and polysaccharide content of cells of *P. aeruginosa* grown on agar and in broth at 37°C

	Growth medium	% dry cell weight		
		104	Smith	PL11
Protein	A3	77	61	82
	B1	95	96	73
Polysaccharide	A3	5.5	5.7	4.8
	B1	3.8	3.6	4.2

Table 6.2.

The divalent metal ion content of the growth media

Growth medium	Divalent metal ion x 10 <sup>-2</sup> /mmol dm <sup>-3</sup>				Total
	Mg	Ca	Fe	Zn	
A3	122	213	6.72	2.85	344.57
B1	10.3	2.3	0.77	0.27	13.64
B1*	6.1	2.0	2.25	0.214	10.56

\* Analysis Chapman (1976)

Table 6.3.

The divalent metal ion content of cells of *P. aeruginosa* grown at 37°C in nutrient agar and nutrient broth

Strain	Growth medium	Divalent metal ion/% dry cell weight				Total
		Mg	Ca	Fe	Zn	
1	A3	0.34	0.62	0.017	0.008	0.985
	B1*	0.27	0.029	0.06	0.006	0.365
100	A3	0.32	0.09	0.009	0.005	0.424
	B1*	0.29	0.026	0.062	0.006	0.384
OSU 64**	-	0.2	0.105	0.012	0.008	0.325

\* Analysis Chapman (1976)

\*\* Analysis Eagon (1969)

Chapman (1976) showed that the total divalent metal ion content (calcium, magnesium, iron, zinc) of resistant and sensitive strains grown in broth was similar; thus there is no apparent relationship between the cellular divalent metal ion content of P. aeruginosa strains and intrinsic gentamicin resistance. The results obtained by Chapman for the iron (II) content of nutrient broth (B1) could not be repeated (Table 6.2). This indicated that the iron (II) results of cells grown in nutrient broth could be spuriously high (cf. Eagon, 1969).

The total divalent metal ion content of cells of resistant and sensitive strains of P. aeruginosa grown on agar was greater than that of cells of these strains grown in broth; this increase in the divalent metal ion content was mainly due to calcium. The divalent metal ion content of sensitive cells grown on agar was significantly greater than that of resistant cells grown on agar; again this was mainly due to calcium; that is, the calcium content was 20 and 3 times greater for cells of strains 1 and 100 respectively grown on agar compared with broth-grown cells.

The magnesium ion content of resistant and sensitive cells grown on both media was similar, although magnesium was present in much larger concentrations in the agar medium than in broth. The divalent metal ion content of resistant cells grown on agar was mainly attributed to magnesium, in contrast to agar-grown sensitive cells, which contained greater amounts of calcium.

### 6.3 Summary

1. The polysaccharide content of strains of P. aeruginosa was greater for cells grown on agar than for those grown in broth.

2. The protein content of agar-grown cells was, in general, less than that of broth-grown cells.

3. Gentamicin-resistant and -sensitive strains grown on agar containing large amounts of divalent metal ions had a greater divalent metal ion content than cells of these strains grown in broth; this increase was mainly attributed to calcium. Sensitive cells had a much greater calcium content than did resistant cells where both were grown on agar.

CHAPTER SEVEN

THE EFFECT OF ANTIBACTERIAL AGENTS ON THE CELL  
SURFACE OF P. AERUGINOSA

Cells of resistant and sensitive strains of P. aeruginosa grown on nutrient agar (A3) containing large amounts of divalent metal ions had a greater divalent metal ion content than did cells of these strains grown in nutrient broth (B1); this was mainly attributed to calcium. To establish whether this increase in divalent metal ion content was related to changes in the composition of the cell envelope and cell surface, experiments using ethylenediaminetetraacetic acid (EDTA) were undertaken.

EDTA has been widely used in studies of cells of P. aeruginosa. EDTA readily forms stable chelate complexes with divalent metal ions. Cells of P. aeruginosa are susceptible to EDTA-lysis (Gray and Wilkinson, 1965 a,b; Haque and Russell, 1974). Extraction of divalent metal ions from the cell envelope by EDTA results in cell disruption (Eagon and Carson, 1965; Roberts et al., 1970); consequently, loss of complex cell components weakens the cell envelope and cell lysis occurs.

#### 7.1 EDTA Lysis of Cells of P. aeruginosa

Cells of P. aeruginosa strains 1, 104 and PL11 were grown on agar or in broth for 18h at 37°C. The cells were harvested and prepared for lysis by EDTA (2.2.10).

The bactericidal action of EDTA against P. aeruginosa involves gross lysis of cells as measured by decreased turbidity of cell suspensions (Repaske, 1956, 1958; Eagon and Carson, 1965).

The control batch of cells for each culture was suspended in barbiturate-acetate buffer solution, and the corresponding test batch of cells in buffer solution containing EDTA ( $0.01 \text{ mol dm}^{-3}$ ) to give an absorbance reading of approximately 0.7 at 660nm. EDTA lysis of cells of gentamicin-resistant and-sensitive cells was

undertaken at pH 8.6. The absorbances of suspensions of control and EDTA treated cells were recorded at regular intervals. The rate and extent of lysis of each cell suspension was determined by the rate of decrease of absorbance with time (Fig. 7.1).

All strains examined showed evidence of lysis in the presence of EDTA, but the rate of lysis during the first two hours was greater for cells of all strains grown on agar. After this time the rate of lysis decreased considerably and cells grown in both media lysed at a similar rate. Sensitive cells were lysed at a similar rate to resistant cells whether these cells were grown in broth or on agar, although the divalent metal ion content of agar-grown sensitive and resistant cells differed. During the experiment the absorbance of the control suspensions decreased slightly; this may be due to settling of the cells from suspension. Lysis was incomplete even after 5h.

## 7.2 The Effect of Subinhibitory Concentrations of EDTA on the Mobility of Cells of *P. aeruginosa*

Cells of gentamicin-resistant and -sensitive strains of *P. aeruginosa* grown on agar containing large amounts of divalent metal ions were lysed more rapidly than cells of these strains grown in broth. The removal of divalent metal ions from the cell envelope and cell surface could result in exposure of negative ionogenic groups capable of contributing to the cell surface charge. A study of the effect of subinhibitory concentrations of EDTA on the mobility of cells of *P. aeruginosa* was undertaken (2.2.10).

Cells of gentamicin-sensitive and -resistant strains 1 and 100 grown on agar or in broth for 18h at 37°C were harvested.



FIGURE 7.1. EDTA lysis of cells of *P. aeruginosa* grown on nutrient agar and in nutrient broth

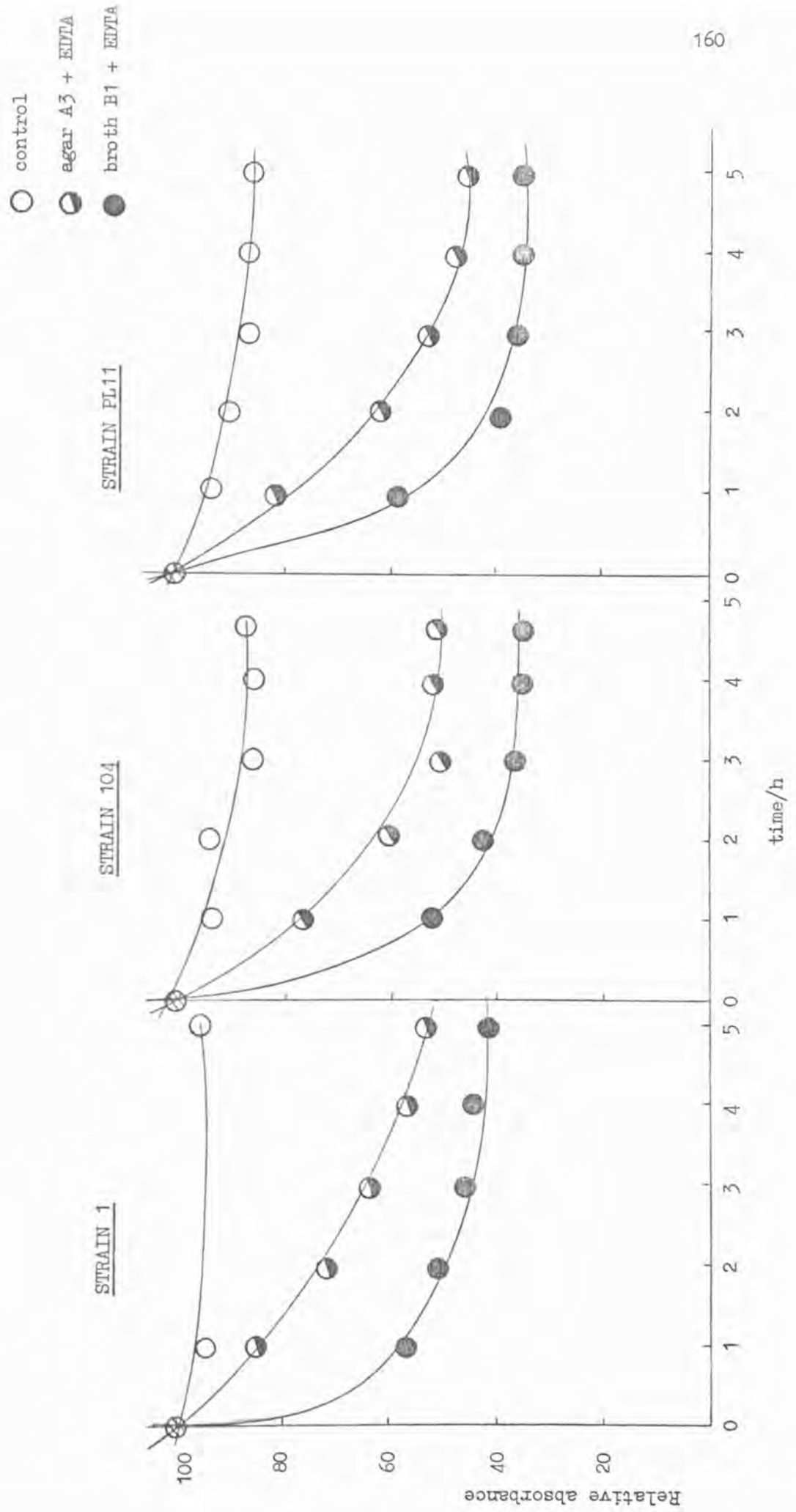

Cells ( $5 \times 10^8 \text{ cm}^{-3}$ ) were suspended for 30 min at  $37^\circ\text{C}$  in buffer solution (pH 7) containing EDTA at a concentration one quarter of the MIC (93 and  $931 \mu\text{g cm}^{-3}$  EDTA for 1 and 100 respectively); at these EDTA concentrations cell lysis did not occur. The cells were subsequently washed with buffer solution and resuspended for mobility measurements. Control cells which had not been treated with EDTA were suspended in buffer solution and the mobility values measured (Table 7.1).

The mobility values of the control agar-grown cells were less than those of the control broth-grown cells, as expected. The mobility of cells of strain 1 and 100 grown in broth was not affected by treatment with EDTA. However, a marked difference in the mobility of the control and EDTA treated cells was observed after growth on agar. The mobility values of cells of both strains grown on agar after EDTA treatment were comparable with those of the control and EDTA treated cells grown in broth.

Thus treatment with EDTA has resulted in a significant increase in the negative ionogenic surface charge of agar-grown sensitive and resistant cells, suggesting the removal of divalent metal ions and possibly other components from the cell envelope and cell surface.

### 7.3 The Effect of Gentamicin in the Growth Media on the Mobility of Cells of *P. aeruginosa*

Cells of resistant and sensitive strains of *P. aeruginosa* grown on agar containing large amounts of divalent metal ions have higher MIC, reduced mobility values and a greater divalent metal ion and polysaccharide content than cells of these strains grown in broth. Treatment with EDTA has shown that divalent metal ions are probably associated with the surface of agar-grown cells.

Table 7.1.

The effect of a subinhibitory concentration of EDTA on  
the mobility at pH 7 of cells of P. aeruginosa  
grown on agar and in broth at 37°C

Growth medium	EDTA Treatment	Mobility $\times 10^8 / \text{m}^2 \text{ s}^{-1} \text{ V}^{-1}$	
		Strain 1	Strain 100
B1	-	2.21	2.03
B1	EDTA	2.17	2.06
A3	-	1.13	1.04
A3	EDTA	2.01	2.10

Table 7.2.

Concentration of calcium and magnesium  
ions in the growth media

Growth medium	Conc. $\text{M}^{2+} \times 10^{-2} / \text{mmol dm}^{-3}$		
	Ca	Mg	Ca + Mg
A3	213	122	355
B1	2.0	6.1	8.1

The following mobility experiments were undertaken to determine whether gentamicin is similarly associated with the cell surface.

There are several theories regarding the increased resistance to gentamicin for cells of P. aeruginosa in the presence of large amounts of divalent metal ions. Ramirez-Ronda et al. (1975) states that enhanced in vitro resistance of P. aeruginosa to gentamicin in the presence of high concentrations of magnesium and calcium ions is associated with decreased binding of gentamicin to P. aeruginosa, and proposed that the initial binding site is the bacterial cell wall. Whereas Chapman (1976) observed the formation of a weak 1:1 calcium-gentamicin complex. A barrier mechanism to gentamicin might result from the formation of a complex between divalent metal ions and ionogenic groups at the cell surface. Competition of divalent metal ions for the cell surface site or for the gentamicin molecule might be indicated by a change in surface properties and hence mobility.

The concentrations of gentamicin in the growth media was varied for each strain because of the need for subinhibitory concentrations. The amount of gentamicin present in the growth media of cells of strain 100 was similar to the concentration of calcium ions in agar (Tables 7.2, 7.3).

Cells of resistant and sensitive strains of P. aeruginosa (1, 100 and 104) were grown for 18h at 37°C on agar and in broth containing subinhibitory concentrations of gentamicin (2.2.11). Control cells were grown on agar and in broth in the absence of gentamicin. The cells were harvested, washed and the mobility values of all cells measured at pH 7.0 (Table 7.4).

Table 7.3.

Subinhibitory concentration of gentamicin  
used in the growth media

Strain	100	104	1
Gm/mmol dm <sup>-3</sup> x 10 <sup>-2</sup>	207	64.6	0.005

Table 7.4.

The effect of a subinhibitory concentration of  
gentamicin in the growth media on the mobility at pH 7.0  
of cells of P. aeruginosa grown at 37°C

Growth medium	Mobility x 10 <sup>-8</sup> /m <sup>2</sup> s <sup>-1</sup> V <sup>-1</sup>		
	Strain 1	100	104
B1 (control)	2.04	1.98	2.01
B1 + Gm	1.84	1.07	1.46
A3 (control)	0.98	1.06	1.19
A3 + Gm	0.90	0.88	1.14

The negative mobility values of gentamicin-resistant cells grown in broth in the presence of gentamicin were significantly lower than those of the control cells. A 10% reduction in the mobility of sensitive cells could be considered significant. The decrease in mobility of cells of 100 grown in broth containing gentamicin was similar to that of cells of 100 grown on agar.

Strains 1, 100 and 104 grown on agar containing subinhibitory concentrations of gentamicin exhibited slightly lower negative mobility values than cells grown on agar in the absence of gentamicin; however the difference between these mobilities was significant only for cells of strain 100.

Thus the presence of gentamicin in the growth medium did not significantly alter the surface charge of agar-grown cells, in contrast to broth-grown cells.

#### 7.4 Summary

1. Cells of gentamicin-resistant and -sensitive strains of *P. aeruginosa* grown on agar are lysed by EDTA more rapidly than cells of these strains grown in broth. Gentamicin-sensitive cells are lysed at a similar rate to resistant cells after growth on agar or in broth.

2. The mobility values of cells of gentamicin-resistant and -sensitive strains treated with EDTA after growth on agar were significantly greater than those of the agar-grown control cells; the values were comparable with those of cells grown in broth.

3. Cells of gentamicin-resistant and -sensitive strains grown in broth containing subinhibitory concentrations of gentamicin had decreased mobility values compared with the control cells grown in broth. Resistant and sensitive cells grown on agar in the presence of gentamicin exhibited mobility values similar to the agar-grown control cells.

CHAPTER EIGHT

THE SURFACE AND BIOLOGICAL PROPERTIES OF  
STAPH.AUREUS STRAINS OF HUMAN AND ANIMAL ORIGIN

The present study on strains of Staph. aureus was undertaken in an attempt to relate the complex phage-typing patterns of the animal strains with their surface and biological properties; a comparison of these properties was made with strains of human origin. The divalent metal ion content of methicillin-resistant and -sensitive cells was studied in relation to antibiotic resistance patterns.

Changes in the growth temperature affect the methicillin resistance properties of strains of Staph. aureus (Sutherland and Rolinson, 1964; Parker and Hewitt, 1970; Al-Salihiy and James, 1972). At 25 and 43°C cells are methicillin-resistant and -sensitive respectively, at 37°C the majority are methicillin-sensitive, but a small minority are resistant. Thus resistance of Staph. aureus to methicillin cannot be tested at 37°C only (Hewitt, Coe and Parker, 1969). Changes in methicillin resistance with temperature are correlated with changes in the surface properties of the cells (Hill and James, 1972b, Al-Salihiy and James, 1972).

The nature and composition of the growth media affects the surface properties of methicillin-resistant and -sensitive cells (Al-Salihiy, 1975) and the activity of the alkaline phosphatase enzyme present in methicillin-resistant strains; this enzyme was shown to be the temperature dependent enzyme of Annear (1968) (Hill and James, 1972a; Davies and James, 1974). The presence of excess inorganic phosphate in solid media has a repressive effect on the activity of this enzyme (Shah and Blobel, 1967; Davies and James, 1974). Cells of Staph. aureus grown in liquid media exhibit little phosphatase activity. It is possible that in liquid media the phosphatase enzyme becomes extracellular and thus could operate to the advantage of the cell (Hill, 1971).



Thus in studies of the surface and antibiotic resistance properties of Staph. aureus the effects of growth temperature and growth media must be considered. Studies on human and animal strains of Staph. aureus were undertaken using agar A4, first prepared in this laboratory by Davies (1974) (2.2.2(iv)). This medium contained low inorganic phosphate (Table 2.5) which is necessary both for good cell growth and high phosphatase activity. In some experiments cells were grown on agar A4 and the untreated agar A1 - a medium which contained excess inorganic phosphate.

#### 8.1 Phage-Typing of Staph. aureus Animal Strains

Phage-typing depends on the ability of some bacteriophages, which are themselves originally lysogenic on strains of Staph. aureus, to lyse other strains of Staph. aureus. An internationally agreed set of phages has been assembled (Table 8.1). The technique of phage typing is described by Blair and Williams (1961).

Staph. aureus strains of human origin are generally lysed by phages from one group only; strains of animal origin often have complex typing patterns or are not lysed by any of the standard phages. The phage-typing of the animal strains was carried out by the Cross-Infection Reference Laboratory, Colindale. The results are recorded as the degree of lysis produced by the individual phages. The phage-typing patterns (Table 8.2) show that these animal strains have either "not-typable" or complex phage-types.

#### 8.2 The Antibiotic Resistance Properties of Strains of Staph. aureus of Human and Animal Origin

Staph. aureus animal strains, together with strains 13136 and Oxford of human origin were grown on agar A1 and A4 at 25, 37 and 43°C. The antibiotic resistance properties were studied using

Table 8.1.

International phage-type set\*

Group I	29	52	52A	79	80					
II	3A	3C	55	71						
III	6	42E	47	53	54	75	77	83A	84	85
Miscellaneous	81	94	95	96						

\* Colindale, 1980

Table 8.2.

Phage-typing of Staph. aureus animal strains

Strain	Colindale reference	Code in text	Phage-type showing > 50 plaques of lysis	Original source
Bovine	75/3333	C1	29/80/+	1
	75/3338	C2	29/52/52A/80/42E/53/54/83A/84/85	2
	75/3342	C3	29/52/52A/80/55/71/83A/96/+	2
	75/3372	C4	29/52/52A/80/83A/81/+	2
	75/3377	C5	+ (42E/81*)	2
	75/3399	C6	+ (6/42E/53/81/+*)	2
Poultry	74/8937	F1	NT (NT*)	3
	74/8942	F2	NT (+*)	3
	74/8943	F3	NT (+*)	3
	74/8950	F4	NT (84*)	3
Porcine	74/1410	P1	3A	4
	74/1411	P2	+ (3A*)	4
	74/1412	P3	29/52/80/81/+	4
	74/1414	P4	29/52/80/81/+	4
	74/1417	P5	NT	4

+ denotes 20-50 plaques of lysis

NT "not typable"

\* Routine Test Dilution (RTD) x 100

1. Veterinary Investigation Dept., Ayr.
2. National Institute for Research in Dairying, Reading.
3. Ministry of Agriculture, Agricultural and Food Bacteriology Research Division, Belfast.
4. Royal Veterinary College, Potters Bar, Herts.

the disc method (2.2.8). The results are shown in Table 8.3.

Oxford was sensitive to all the antibiotics; the antibiotic sensitivities were not, in general, altered by growth on agar A1 or A4 at 25, 37 or 43°C. 13136 was resistant to penicillin G, streptomycin and tetracycline, and sensitive to chloramphenicol and erythromycin after growth on both agar A1 and A4 at 25, 37 and 43°C. However, cells grown on A1 media at 25°C exhibited increased sensitivity to tetracycline. The methicillin resistance properties of this strain varied with changes in the growth temperature, as expected; cells were resistant at 25°C, moderately sensitive at 37°C and very sensitive at 43°C.

The animal strains were sensitive to the antibiotics chloramphenicol, streptomycin, erythromycin, methicillin and tetracycline after growth on both A1 and A4 media at 25, 37 and 43°C. Sensitivity to tetracycline was reduced when the porcine strains P3 and P4 were grown on A4 compared with A1 media at 37 and 43°C. Resistance to penicillin G was observed in porcine P4, the bovine strains C2, C3 and C4 and the four poultry strains. Poultry strains F2 and F4 lost their resistance to penicillin when grown at 43°C.

A significant reduction in the zones of inhibition by tetracycline was observed when cells of all strains were grown on A4 compared with A1 media. (Table 8.4).

### 8.3 Detection of the Penicillinase Enzyme

Some animal strains of Staph. aureus resistant to penicillin G were tested by a modification of the method of Perret (1954) (2.2.14) for their ability to produce penicillinase. Controls of a penicillinase-producing strain and a penicillinase-negative strain (13136 and 9341 respectively) were included. Cells were grown for 18h at 37°C on agar A4. The results (Table 8.5) show that the animal strains of Staph. aureus resistant to penicillin produce the enzyme penicillinase.

Table B.3.

Antibiotic resistance properties of *Staph. aureus* animal strains

Antibiotic	Growth media	Growth Temp/°C	Strains																		
			C1	C2	C3	C4	C5	C6	F1	P2	F3	F4	P1	P2	P3	P4	P5	Oxford	13136		
PG	A1	25	-	-	R	R	S	S	-	-	R	R	-	S	S	R	S	S	R		
			S	R	R	R	S	R	R	-	S	S	R	-	S	S	R	S	S	R	
			-	-	-	R	S	-	-	R	-	R	S	-	S	S	R	S	S	S	R
PG	A4	25	S	R	R	R	S	S	R	R	R	R	S	S	S	R	S	S	S	R	
			S	R	R	R	S	R	R	-	S	S	R	S	S	S	R	S	S	S	R
			-	-	R	R	S	R	R	S	S	R	S	S	S	S	R	S	S	S	R
Cm, Sm, E, Tc, Mt	A1	25/37/ 43	-	-	S	S	S	S	S <sup>2</sup>	S <sup>2</sup>	S	S	-	S	S	S	S	S	S	* <sup>1</sup>	
			S	S	S	S	S	S	S	S	S	S	S	S	S	S	S	S	S	S	* <sup>1</sup>
Tc	A4	25	S	S	S	S	S	S	S	S	S	S	S	S	S	S	S	S	S	R	
			S	S	S	S	S	S	S	S	S	S	S	S	S	S	S	S	S	S	R
Te	A4	37/43	S	S	S	S	S	S	S	S	S	S	S	S	S	R	R	S	S	R	
			S	S	S	S	S	S	S	S	S	S	S	S	S	S	R	R	S	S	R

PG, penicillin G; Cm, chloramphenicol; Sm, streptomycin; E, erythromycin; Tc, tetracycline; Mt, methicillin; S, sensitive; R, resistant;

<sup>1</sup>\* 13136 sensitive to Cm, E; resistant to PG, Sm, Tc (25°C some inhibition of growth on A1 by Tc);

Mt (heterogeneous response to Mt; cells become Mt sensitive at 45°C);

<sup>2</sup>A1 medium, measured at 37°C only.

Table 8.4.

Percentage decrease in the zones of inhibition by tetracycline for cells of Staph. aureus grown on A4 medium

Growth Temp/°C	Strains																
	C1	C2	C3	C4	C5	C6	F1	F2	F3	F4	P1	P2	P3	P4	P5	Oxford	13136
25	-	-	47	43	10	9	-	-	17	23	-	17	23	36	30	45	19
37	-	-	48	39	32	11	16	47	26	30	-	39	44	42	21	25	40
43	-	-	43	35	16	10	-	-	29	32	-	32	37	42	30	25	21

Table 8.5.

Detection of penicillinase in cells of Staph. aureus

Strain	C1	C2	C3	C4	F2	F3	P1	P3	P4	9341	13136
Penicillin G	S	R	R	R	R	R	S	S	R	S	R
Penicillinase	pen <sup>-</sup>	pen <sup>+</sup>	pen <sup>+</sup>	pen <sup>+</sup>	pen <sup>+</sup>	pen <sup>+</sup>	pen <sup>-</sup>	pen <sup>-</sup>	pen <sup>+</sup>	pen <sup>-</sup>	pen <sup>+</sup>

S, sensitive; R, resistant; pen<sup>+</sup>, penicillinase producer; pen<sup>-</sup>, penicillinase negative.

#### 8.4 The Metal Ion Resistance Properties of Strains of Staph. aureus of Animal and Human Origin

The metal ion resistance properties of a selection of the animal strains grown on A4 media, together with cells of methicillin-resistant strain 13136 and sensitive strains 9341 and Oxford grown on agar A1 or A4 at 37°C for 18h were studied. Discs containing the ions magnesium, zinc, copper, cadmium, arsenate and phenylmercury were prepared (2.2.13) and inhibition of bacterial growth examined by the method of flooding (2.2.8). The results are listed in Table 8.6; duplicate results were in good agreement.

Growth was not inhibited by the presence of magnesium, zinc, copper or arsenate ions on either agar A1 or A4; 13136 was not inhibited by phenylmercury ions, but Oxford, 9341 and the animal strains were inhibited to some extent. Cadmium did not inhibit the growth of cells of 13136 or Oxford on A1 or A4 media, or of 9341 on agar A1. However, cadmium greatly inhibited the growth of cells of 9341 and the animal strains on agar A4.

#### 8.5 pH-Mobility Curves of Strains of Staph. aureus of Animal and Human Origin

A study was made of the surface properties of methicillin-resistant strain 13136 and methicillin-sensitive strain 9341 grown on media A1 or A4 at 37 and 43°C. The pH-mobility curves of several strains taken from each animal group were determined after growth on agar A4 for 18h at 25, 37 and 43°C. The cells were prepared for electrophoresis (2.2.7). All mobility measurements were carried out at 25°C.

Brewer (1966) defined the H-value as the increase in the mobility value at the maximum at pH 3.5-4 compared with the mobility value at pH 7, expressed as a percentage of the mobility at pH 7; ie.

Table 8.6.

The metal ion resistance properties of strains of Staph. aureus

metal ions	Strains/growth media													
	C1	C3	F2	F3	P1	P3	P4	13136		9341		Oxford		
	A4	A4	A4	A4	A4	A4	A4	A1	A4	A1	A4	A1	A4	
Mg	R	R	R	R	R	R	R	R	R	R	R	R	R	R
Zn	R	R	R	R	R	R	R	R	R	R	R	R	R	R
Cu	R	R	R	R	R	R	R	R	R	R	R	R	R	R
Cd	S	S	S	MS	S	S	S	R	R	R	S	R	R	R
Asa	R	R	R	R	R	R	R	R	R	R	R	R	R	R
PhHg	MS	S	MS	S	MS	S	S	R	R	S	S	S	S	S

S, sensitive; R, resistant; MS, moderately sensitive;  
Asa, arsenate; PhHg, phenylmercury ions.

Table 8.7.

The H-values of strains of Staph. aureus

Growth Temp/°C	Strains/growth media											
	C1	C3	F2	F3	P1	P3	P4	13136		9341		
	A4	A4	A4	A4	A4	A4	A4	A1	A4	A1	A4	
25	-	-	-	-	3	15	-	-	-	-	-	-
37	-3	20	45	53	13	59	60	4	33	83	80	
43	6	26	26	15	4	17	15	30	25	-	-	

$$H \text{ value} = \left( \frac{\bar{v}_{\text{max}} - \bar{v}_{\text{pH } 7}}{\bar{v}_{\text{pH } 7}} \right) \times 100$$

The H values are shown in Table 8.7.

At low pH values the negative mobility of cells of methicillin-resistant strain 13136 increased to a maximum at pH 3.5 - 4 followed by a steep decline to a minimum at pH 4.5, after which the mobility increased to a constant value at pH 7. The shape and position of the pH-mobility curves of cells of 13136 grown on agar A1 at 37 and 43°C, and agar A4 at 43°C were similar (Fig. 8.1b). However, there was a significant decrease in the maximum mobility and H-value when these cells were grown at 37°C on A4 media, indicating a reduction in the number of ionogenic groups on the cell surface at low pH values.

Cells of the methicillin-sensitive strain 9341 exhibited a high maximum mobility at pH 3.5 - 4 which decreased rapidly to a constant value at pH 7; no minimum mobility value was observed (Fig. 8.1a). Similar pH-mobility curves and H-values were obtained on both A1 and A4 media at 37°C.

The pH-mobility curves of a selection of animal strains could, in general, be correlated with typical curves of methicillin-sensitive and -resistant strains of human origin (Fig. 9.2). However, the "not-typable" penicillin-resistant poultry strains F2, F3 exhibited complex pH-mobility curves (Fig. 8.3) the shape of which were not typical of those in Fig. 9.2. These curves exhibited two maxima (pH 3.5, 5) and two minima (pH 4.5, 6); the minimum mobility at pH 4.5 was much greater than the mobility value at pH 7, in contrast to methicillin-resistant cells of human origin. Cells of F2 lost



FIGURE 8.1a. pH-mobility curves of cells of Staph. aureus methicillin-sensitive strain 9341

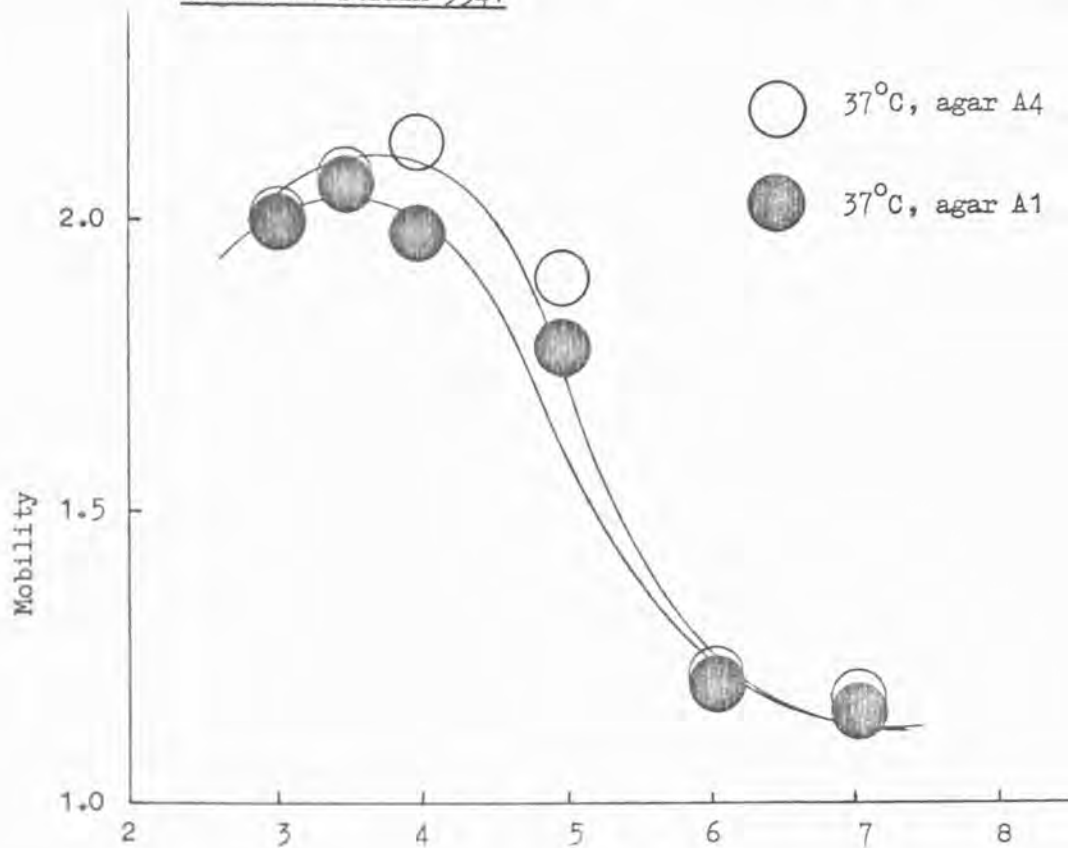
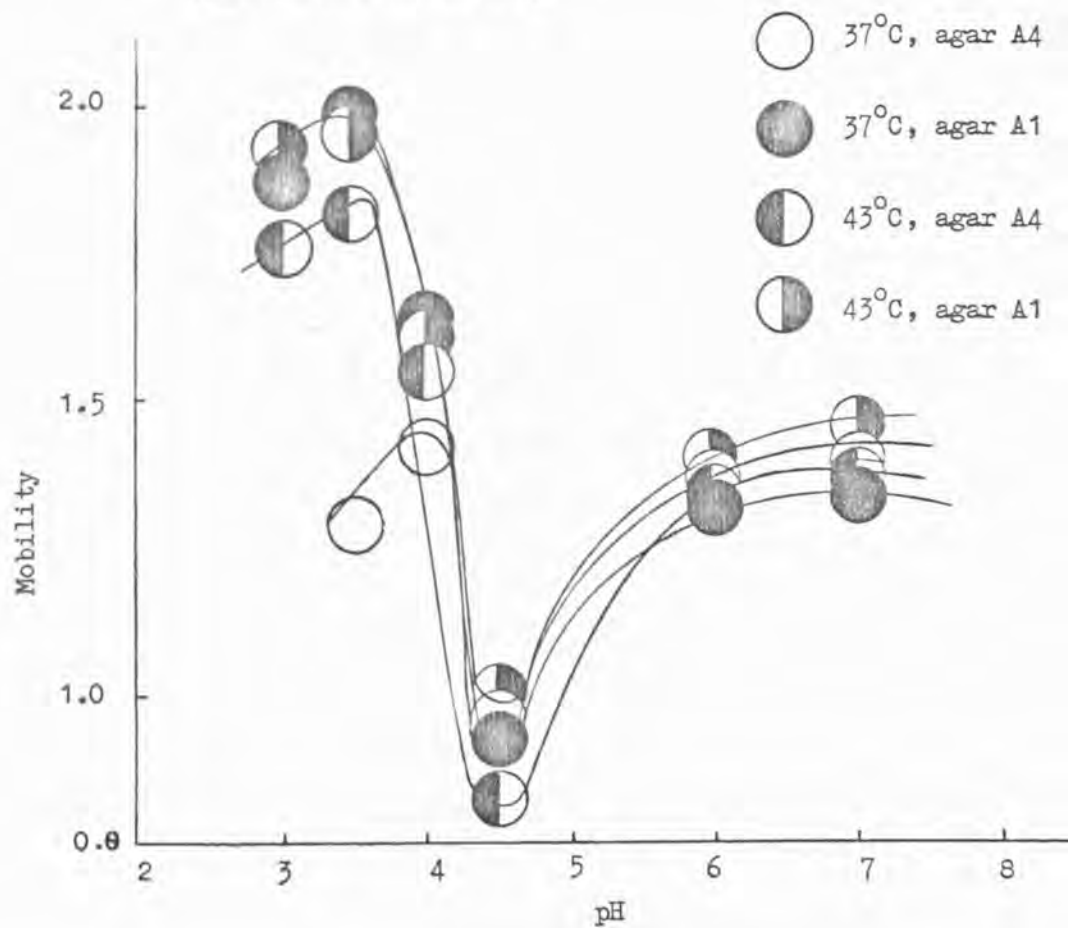

FIGURE 8.1b. pH-mobility curves of cells of Staph. aureus methicillin-resistant strain 13136



their penicillin resistance at 43°C, but the shape of the pH-mobility curve did not alter. The porcine strains P3, P4 (penicillin-sensitive and -resistant respectively) possessed similar, complex phage-types and exhibited the A-shaped curve characteristic of a methicillin-sensitive strain (Figs. 8.4, 8.5). Penicillin-sensitive P1, which possessed a different phage-type, also exhibited an A-shaped curve at 37°C, but at 25 and 43°C the curves were the D- and C-shapes of a methicillin-resistant strain (Fig. 8.4). Cells of the antibiotic-sensitive bovine strain C1 exhibited pH-mobility curves similar in shape to those of methicillin-resistant 13136 grown at the same temperatures (D,C,B; Fig. 8.2b) but the phage-types differed. Cells of penicillin-resistant C3, which had a different complex phage-type, exhibited surface properties which at 37°C resembled those of a methicillin-sensitive strain (A) and at 43°C those of a resistant strain which had become sensitive (B; Fig 8.2a). At 25°C the pH-mobility curves of strains C1 and P1 were characteristic of a simple anionic surface (D; Fig. 8.2b, 8.4).

Cells of the porcine and poultry strains grown at 37°C exhibited a higher maximum mobility and H-value than cells of these strains grown at 43°C whereas the bovine strains and the methicillin-resistant strain of human origin had a higher maximum mobility and H-value at 43°C.

#### 8.6 The Effect of Periodate Treatment of Cells of Animal Strains of Staph. aureus on their Surface Properties.

Strains C1 and P3 were grown for 18h at 25, 37 and 43°C on A4 medium. The cells were harvested, washed, and treated with sodium metaperiodate (2.2.15). The pH-mobility curves are shown in Figs. 8.2b and 8.5.

After treatment with sodium metaperiodate cells of C1 grown at 37 and 43°C and P3 grown at 25, 37 and 43°C had completely altered pH-mobility curves. The negative mobility at low pH values increased to a plateau value at approximately pH 7. Thus oxidation with periodate

FIGURE 8.2a. pH-mobility curves of cells of the Staph. aureus bovine strain C3 grown on agar A4

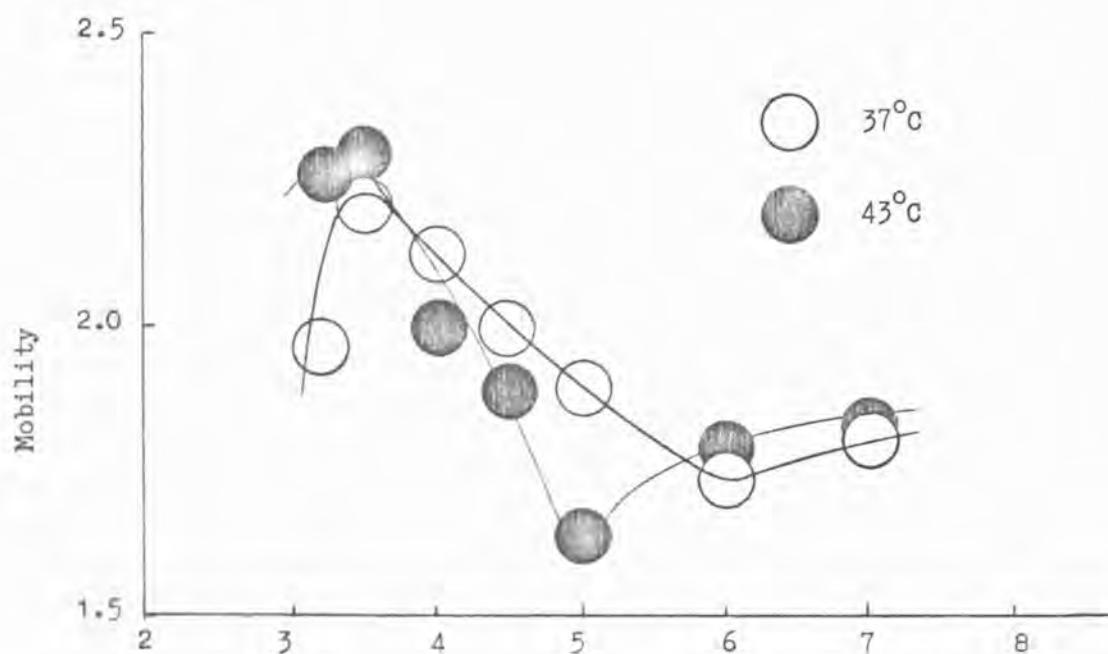

FIGURE 8.2b. pH-mobility curves of cells of the Staph. aureus bovine strain C1 grown on agar A4

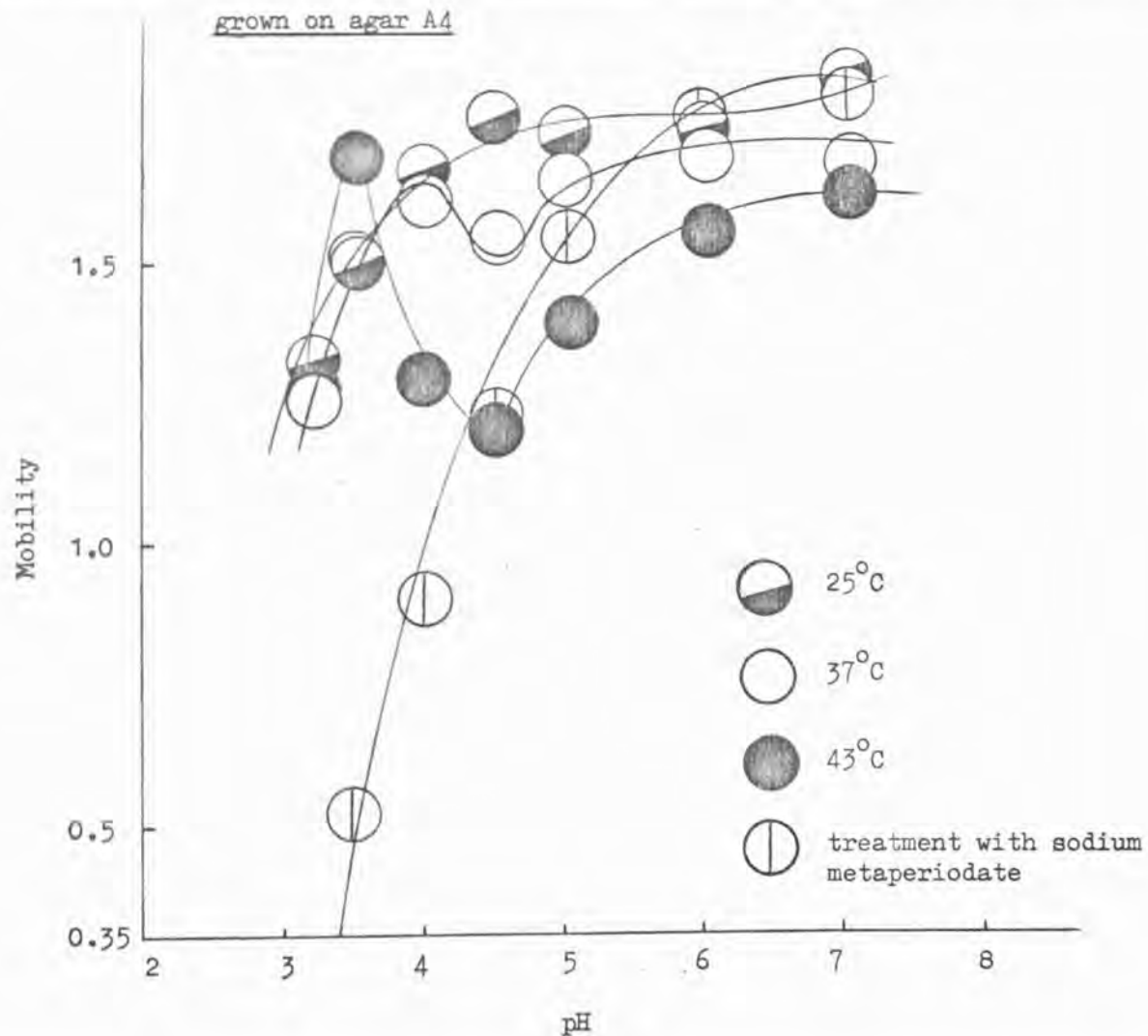

FIGURE 8.3. pH-mobility curves of cells of the Staph.aureus poultry strains F2, F3 grown on agar A4

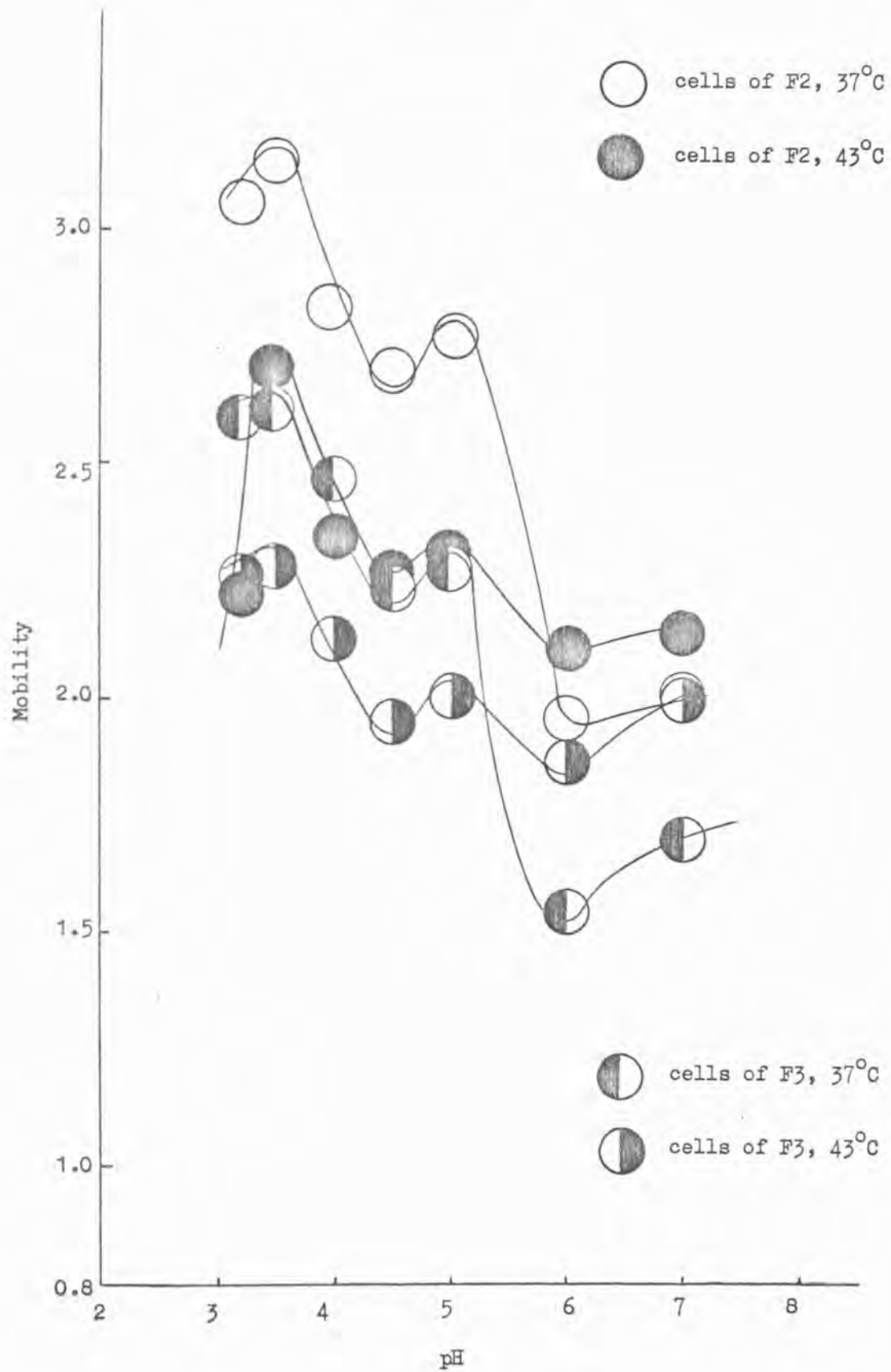

FIGURE 8.4. pH-mobility curves of cells of the Staph. aureus  
porcine strains P1, P4 grown on agar A4

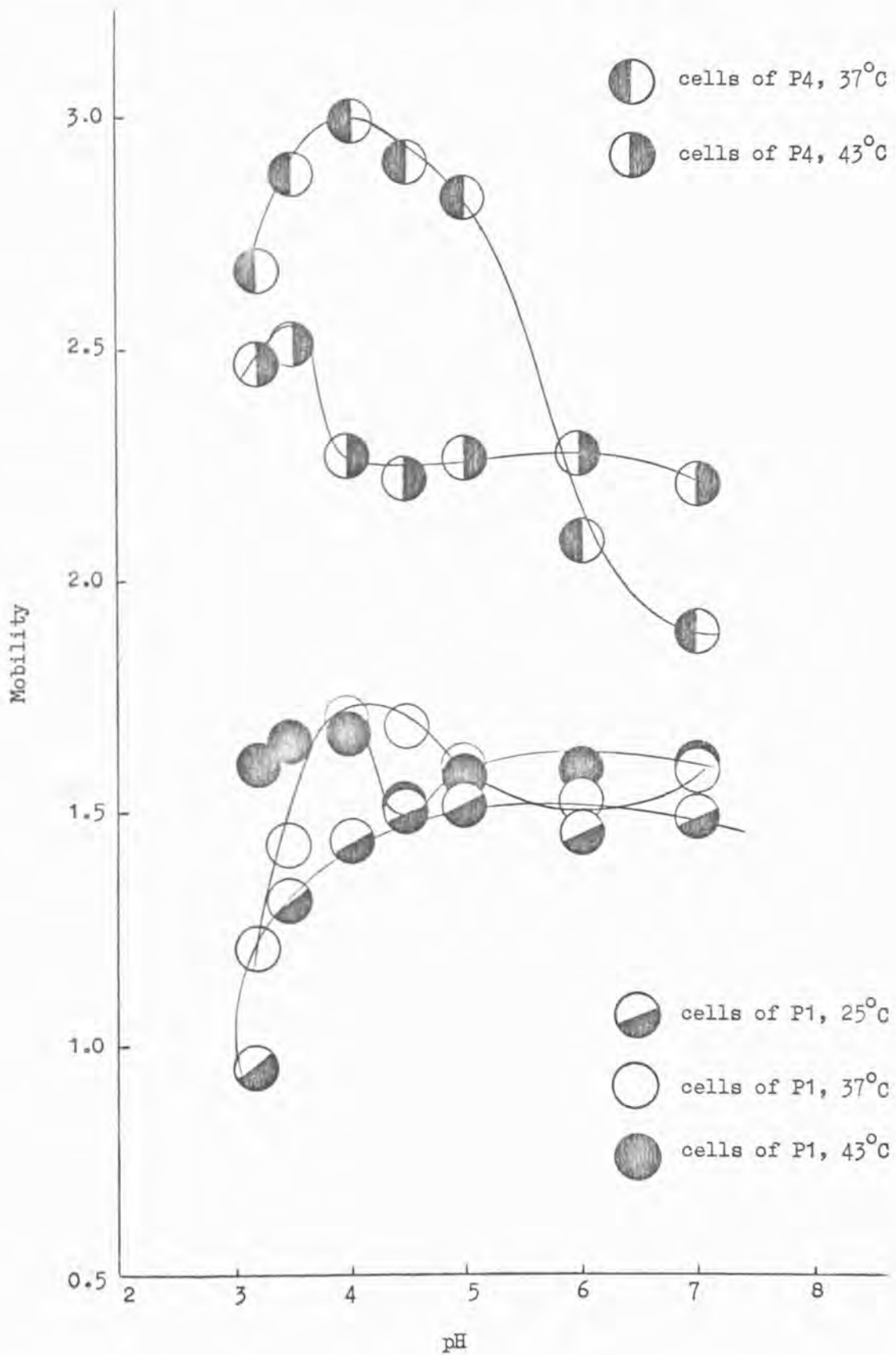
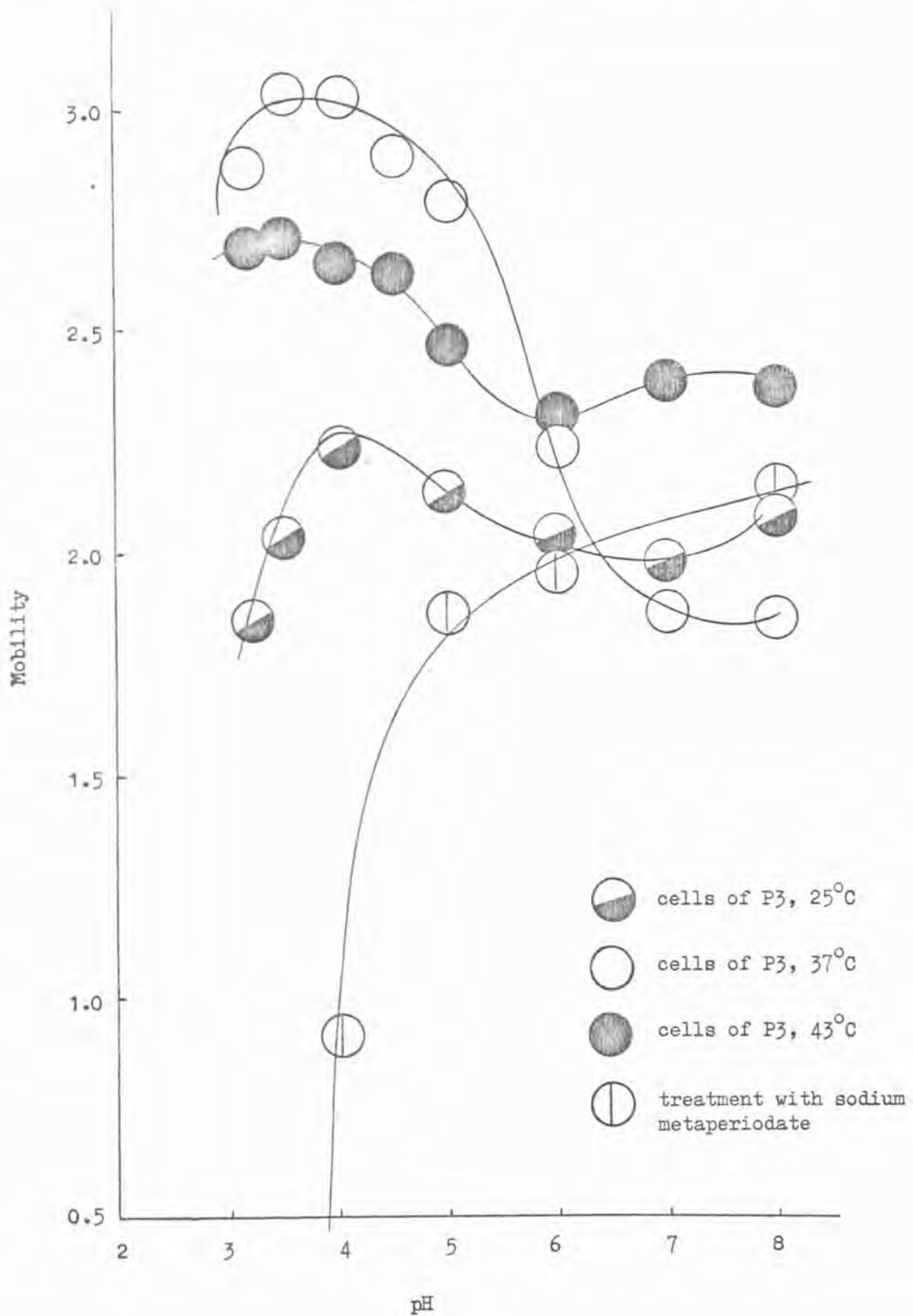

FIGURE 8.5. pH-mobility curves of cells of the Staph.aureus porcine strain P3 grown on agar A4



has removed the ionogenic groups responsible for the maximum mobility at low pH values.

#### 8.7 The Divalent Metal Ion Content of Methicillin-Sensitive and Resistant Strains of Staph. aureus Grown on Agar

Cells of strains 13136, 9341 and Oxford were grown on A1 and/or A4 media at 37°C, and prepared for the determination of their divalent metal ion content by atomic absorption analysis (2.3.2).

The divalent metal ion content of the agar media used (A1 and A4) was also determined (Table 8.8). The divalent metal ions present in both agar A1 and A4 were in the order: calcium, magnesium, iron, zinc, copper, cadmium. The total divalent metal ion content of agar A4 was greater than that of agar A1; this was mainly attributed to an increase in calcium due to the use of calcium hydroxide to precipitate the excess inorganic phosphate.

The order of the divalent metal ion content of strains 13136, 9341 and Oxford (Table 8.9) grown on A1 and A4 media was magnesium, iron, calcium, zinc, copper, cadmium. Thus magnesium is the most abundant divalent metal ion present in cells of Staph. aureus, whereas calcium the most abundant divalent cation in the growth media. The total divalent metal ion content of cells of 13136 grown on agar A4 is significantly less than that of these cells grown on A1 media; this is attributed to a significant reduction in magnesium. However, the total divalent metal ion content of 9341 is greater when cells are grown on A4 compared with A1 media; an increase which is partly attributed to calcium. An increase in calcium of 5 and 10 fold, and a decrease in magnesium of 1.3 and 2 fold occurred in cells of 9341 and 13136 respectively when grown on A4 compared with A1 media. The iron content of resistant and sensitive cells is also increased after growth on agar A4, although this is more pronounced for the sensitive strain. The concentrations of zinc

Table 8.8.

The divalent metal ion content of the growth media

Growth medium	Divalent metal ion content x $10^{-2}/\text{mmol dm}^{-3}$						Total
	Mg	Ca	Zn	Fe	Cu	Cd	
A1	15.1	18.3	0.28	3.9	0.12	0.09	37.58
A4	13.5	282.0	0.285	3.55	0.12	0.09	299.33

Table 8.9.

The divalent metal ion content of methicillin-resistant and-sensitive cells of Staph. aureus

Strain	growth medium	Divalent metal ion/% Dry cell weight						Total*
		Mg	Ca	Zn	Fe	Cu	Cd	
13136	A1	0.30	0.008	0.007	0.050	0.00035	0.00016	0.365
	A4	0.15	0.074	0.006	0.084	-	-	0.314
9341	A1	0.22	0.021	0.007	0.064	-	-	0.312
	A4	0.17	0.099	0.010	0.147	-	-	0.426
Oxford	A1	0.23	0.007	0.007	0.039	0.0005	0.00021	0.283

\* Total divalent metal ion content of the ions Mg, Ca, Zn, Fe.



present in cells of all strains grown on both A1 and A4 media are similar, while the amounts of copper and cadmium in the cells were minute.

#### 8.8 Summary

1. The phage-typing pattern of animal strains of Staph. aureus were complex or "not-typable".
2. The animal strains were sensitive to the antibiotics chloramphenicol, streptomycin, methicillin, erythromycin, and in general, to tetracycline. Some strains were resistant to penicillin G due to the presence of the enzyme penicillinase.
3. Changes in the growth temperature and growth media did not affect the antibiotic sensitivities of the animal strains with two exceptions: two porcine strains became penicillin-sensitive when grown at 43°C; growth on A4 media produced strains with a reduced sensitivity to tetracycline.
4. Growth of Staph. aureus was not inhibited by magnesium, zinc, copper or arsenate ions. Growth was inhibited by phenylmercury ions (except the methicillin-resistant strain). Methicillin-sensitive and resistant strains were resistant to cadmium when grown on agar A1. The animal strains and one methicillin-sensitive strain were cadmium-sensitive on agar A4.
5. The pH-mobility curves of cells grown at 37 and 43°C exhibited a maximum at pH 3.5 - 4, thereafter decreasing to a plateau value at about pH 7. Some strains exhibited a minimum mobility value at pH 4.5. At 25°C some pH-mobility curves were characteristic of an anionic surface.
6. The H-values of the porcine and poultry strains were greater after growth at 37 than at 43°C; the reverse was true of bovine strains.

7. Treatment of strains with sodium metaperiodate resulted in the removal of ionogenic groups responsible for the maximum mobility at pH 3.5 - 4.

8. Methicillin-resistant cells possessed greater amounts of magnesium but less calcium than methicillin-sensitive cells on A1 media. However, the magnesium and calcium content of these strains was similar after growth on agar A4.

CHAPTER NINE

DISCUSSION

Particulate microelectrophoresis is an important technique which can be used to study the surface of bacterial cells and other organisms, such as blood, tissue and tumor cells. Unlike chemical methods of analysis, which cause cell disruption, it has the advantage that individual whole living cells can be studied under the microscope in a buffered environment and valuable information obtained about the surface ionogenic groups of these cells. Since the surface of the bacterial cell is often the first and final site of attack by an antibacterial agent, the study of bacterial cell surfaces and their structural changes can assume an important role in the understanding of the mechanisms whereby bacteria become resistant to antibacterial agents.

Gentamicin, an aminoglycoside antibiotic, is used frequently in clinical situations where infection is due to P. aeruginosa a Gram-negative organism resistant to many antibiotics. In recent years isolation of P. aeruginosa strains possessing resistance to gentamicin has become more common, and is cause for great concern. Thus many studies have been undertaken to try to elucidate the possible mechanisms of resistance involved.

The mode of action of gentamicin has been shown to take place in the cytoplasm; by attaching itself to the 30s ribosome, inhibiting synthesis of proteins required by the cell. However, the gentamicin molecule must first be able to penetrate the cell to get to its site of action.

Resistance to gentamicin in some strains of P. aeruginosa is due to the presence of R-factors; extrachromosomal enzymes, plasmid mediated, and capable of transferring the resistance properties of the cell to other strains of P. aeruginosa, and in some cases to other Enterobacteriaceae.

Another form of resistance, termed intrinsic resistance, is probably due to the presence of some barrier in the cell envelope; this could be related to the presence of surface lipid (Pechey, 1973; Pechey et al., 1974; Chapman, 1976). Bradley et al., (1975) have shown that the growth temperature can significantly affect the lipid composition of P. aeruginosa, greater amounts being observed at lower temperatures of growth. These variations in the lipid are significant since varied growth temperatures in the factory or hospital might result in contamination of pharmaceutical preparations or wounds. This emphasizes the importance of identifying changes in the structure of the cell envelope which could lead to the formation or reduction of an intrinsic barrier of resistance to the gentamicin molecule.

The presence of excess divalent metal ions (calcium and magnesium) in the growth media has also been shown to increase the gentamicin resistance of P. aeruginosa strains. (Gilbert et al., 1971; Zimelis and Jackson, 1973).

A decrease in resistance to gentamicin over a number of years resulted in some laboratory-stored strains of P. aeruginosa becoming sensitive to gentamicin, and this change in the sensitivity pattern has been correlated with changes in surface properties as detected by electrophoresis (Chapman, 1976). At high temperatures repeated subculture is effective in the eradication of methicillin resistance from Staph. aureus, together with changes in surface properties (Al-Salihi, 1975).

The present work on P. aeruginosa was undertaken using particulate microelectrophoresis to study changes in the surface properties of resistant and sensitive strains due to variations in growth temperature and growth media, and to repeated subculture which could be related

to any changes in resistance to gentamicin. The three temperatures of study used were 25°C, room temperature; 37°C, body temperature and 43°C, an elevated temperature near the maximum growth temperature of P. aeruginosa. Resistant strains possessing intrinsic gentamicin resistance, and resistance due to the presence of R-factors were studied, together with a sensitive strain as control.

The commercial growth media used in this study of P. aeruginosa were Oxoid nutrient broth CM1 (B1) and Oxoid nutrient agar CM3 (A3); the latter had a high concentration of divalent metal ions. The state of the medium (i.e. solid or liquid) does not affect the electrokinetic properties of P. aeruginosa (Chapman, 1976). A greater understanding of the effects of divalent metal ions on gentamicin resistance is necessary if P. aeruginosa infection is to be successfully treated in certain clinical situations. For example, where the patient is suffering from hypercalcaemia, analysis of resistance on commercial media not containing similarly high levels of calcium would result in incorrect interpretation of MIC values and thus the efficacy of the antibiotic would be reduced. Thus the culture media must closely approximate to the physiological condition before extrapolation of antibiotic sensitivities from an in vitro to an in vivo situation can take place.

The nature of the surface charge on a bacterium can be investigated by studying the variation of electrophoretic mobility with changes in factors such as pH, ionic strength and salt components of the suspension medium, the presence of surface active agents, treatment with enzymes and chemical reagents.

The phenomenon of electrophoresis may be readily explained by the presence of an electrical double layer at the interface between the charged bacterial cell surface and the suspending electrolyte giving rise to a potential termed the zeta potential ( $\zeta$ ) which is

defined as the potential between the liquid side of the fixed part of the double layer and the bulk of the solution; i.e. the potential drop across the freely mobile portion of the electrical double layer. The zeta potential is dependent upon two factors, the nature of the suspension medium, particularly the pH and ionic strength, and by the quantity and charge of the ionogenic groups present at the bacterial cell surface. On application of an electric field the positive and negative portions of the double layer must be displaced relative to one another, and since the bacteria are free to move they will migrate in the electric field. Ions of high valence have a marked effect on the zeta potential even to the extent of reversing the sign while changes in the outer portion of the double layer will also markedly alter the potential gradient in the fixed part. However, the thermodynamic potential  $E$ , the potential between the bulk of the solid and the bulk of the solution, is hardly affected.

Since the values of the permittivity and coefficient of viscosity in the electrical double layer are not accurately known, zeta potentials cannot be calculated with any reliability; results are therefore quoted in terms of the measured mobility values which in buffered solutions of fixed ionic strength are directly related to the zeta potential.

Helmholtz (1879), who first pioneered research in electrophoresis, demonstrated that the electrophoretic mobility was related to the zeta potential and further development by Smoluchowski (1921) resulted in the equation:

$$\bar{v} = \frac{\epsilon \zeta}{4\pi\eta} = \frac{\epsilon_0 \epsilon_r \zeta}{\eta}$$

where  $\eta$  is the coefficient of viscosity,  $\epsilon_0$  and  $\epsilon_r$  the permittivity of free space and relative permittivity of the medium respectively.

The validity of the Smoluchowski equation is dependent upon the assumption that the values of viscosity and relative permittivity within the electrical double layer are the same as bulk water. However, this assumption has been questioned by several workers, who suggest that these may have abnormal values in the double layer where the local electrical field strength may be high, and therefore viscosity is greater and relative permittivity less than the values in the bulk phase.

The net result of the variation of permittivity and viscosity with potential is that  $\epsilon/\eta$  falls off sharply with rise in the potential gradient. Chatteraj and Bull (1959) and Haydon (1960) state that neglect of any difference between bulk and double layer viscosity and relative permittivity only introduces small errors in biological systems, and that the surface conductance of the particle is the important factor in determining the electrophoretic properties of ionogenic groups.

The electrophoretic mobilities obtained are relative and not absolute values, since the cross-sectional area of the electrophoretic chamber necessary for the calculation of absolute mobility values is not measurable directly. This does not affect the interpretation of the pH-mobility curves since it is changes in surface properties of bacterial cells which are important.

The surface studied by this technique is a region within a few Angstroms of the actual surface, defined in terms of those ions at the surface, or those ionogenic components of the peripheral zone of the particle. For biological cells this zone is considered to be the outer portion of the cell membrane where the volume not occupied by macromolecular structures is accessible to ions and small molecules.



The preparation of cells for mobility measurements was carried out under controlled conditions, including standardised growth and washing conditions, to ensure that a reproducible cell surface free from adsorbed material such as components of the growth medium and toxins was produced. Constant conditions of pH and ionic strength were used to ensure that the mobility values were meaningful and comparable. Mobility measurements were only made over a limited predetermined pH range to avoid denaturation of the cell surface at high and low pH values. The experimental conditions necessary to produce a reproducible surface for cells of P. aeruginosa and Staph. aureus and the conditions required for determination of pH-mobility curves were established by Pechey (1973) and Brewer (1966) respectively. Cells of P. aeruginosa are motile due to the presence of a single polar flagellum; however, at 10°C this motility is suppressed. Mobility measurements on cells of P. aeruginosa were therefore undertaken at 10°C, in contrast mobility measurements of cells of Staph. aureus were made at 25°C.

The electrophoretic apparatus was calibrated daily before use with a particle of known mobility. The primary standard reference is human erythrocytes suspended in 0.667 mol dm<sup>-3</sup> phosphate buffer at pH 7.35; the secondary standard reference, 18h cells of K. aerogenes suspended in veronal-acetate buffer solution at pH 7 was used in this work at the relevant ionic strength. The confidence limit for a single mean at  $p = 0.05$  is  $\pm 3\%$ , thus cells with mobility values differing by 10% or more have significantly different surfaces.

During the course of the present work experiments were carried out on strains of P. aeruginosa to determine MIC values, pH-mobility curves and surface lipid content. Cells were subjected to changes in growth temperature, growth media and to repeated culture.

Cells of *P. aeruginosa* are classified as gentamicin-sensitive if growth is inhibited by  $<12 \mu\text{g cm}^{-3}$ , but resistant if growth occurs above  $>12 \mu\text{g cm}^{-3}$  of the gentamicin base. This classification was proposed since serum levels of gentamicin greater than 12 to 15  $\mu\text{g cm}^{-3}$  are seriously ototoxic (Jao and Jackson, 1963; Wersall et al., 1969).

The pH-mobility curves reflect variations in the dissociation of ionogenic groups of the bacterial cell surface with pH.

The pH-mobility curve may be classified as either wave-shaped, (SN), characteristic of a gentamicin-sensitive strain, or R-shaped characteristic of a gentamicin-resistant strain, as shown in Fig. 9.1.

The wave (W) value is an attempt to quantify one significant facet of the curve. The W value is defined by:

$$W = \frac{\bar{v}_{\max} - \bar{v}_{\min}}{\bar{v}_{\max}} \times 100$$

where  $\bar{v}_{\max}$  is the value of the first maximum mobility reached as the pH is increased, and  $\bar{v}_{\min}$  the value of the subsequent minimum mobility. A W value greater than 10 indicated that the wave-shape of the pH-mobility curve was significant and the strain sensitive to gentamicin. To permit comparison of the surface properties of the same cells grown in broth or on agar a D value was calculated from:

$$D = \frac{\bar{v}_{B1} - \bar{v}_{A3}}{\bar{v}_{B1}} \times 100$$

where  $\bar{v}_{B1}$  is the value of the first maximum mobility in broth and  $\bar{v}_{A3}$  the value of the first maximum mobility in agar.  $D > 10$  indicates that the surface properties of cells grown in broth or on agar are significantly different.

FIGURE 9.1 Typical pH-mobility curves of gentamicin-resistant (intrinsic) and -sensitive strains of *P. aeruginosa*

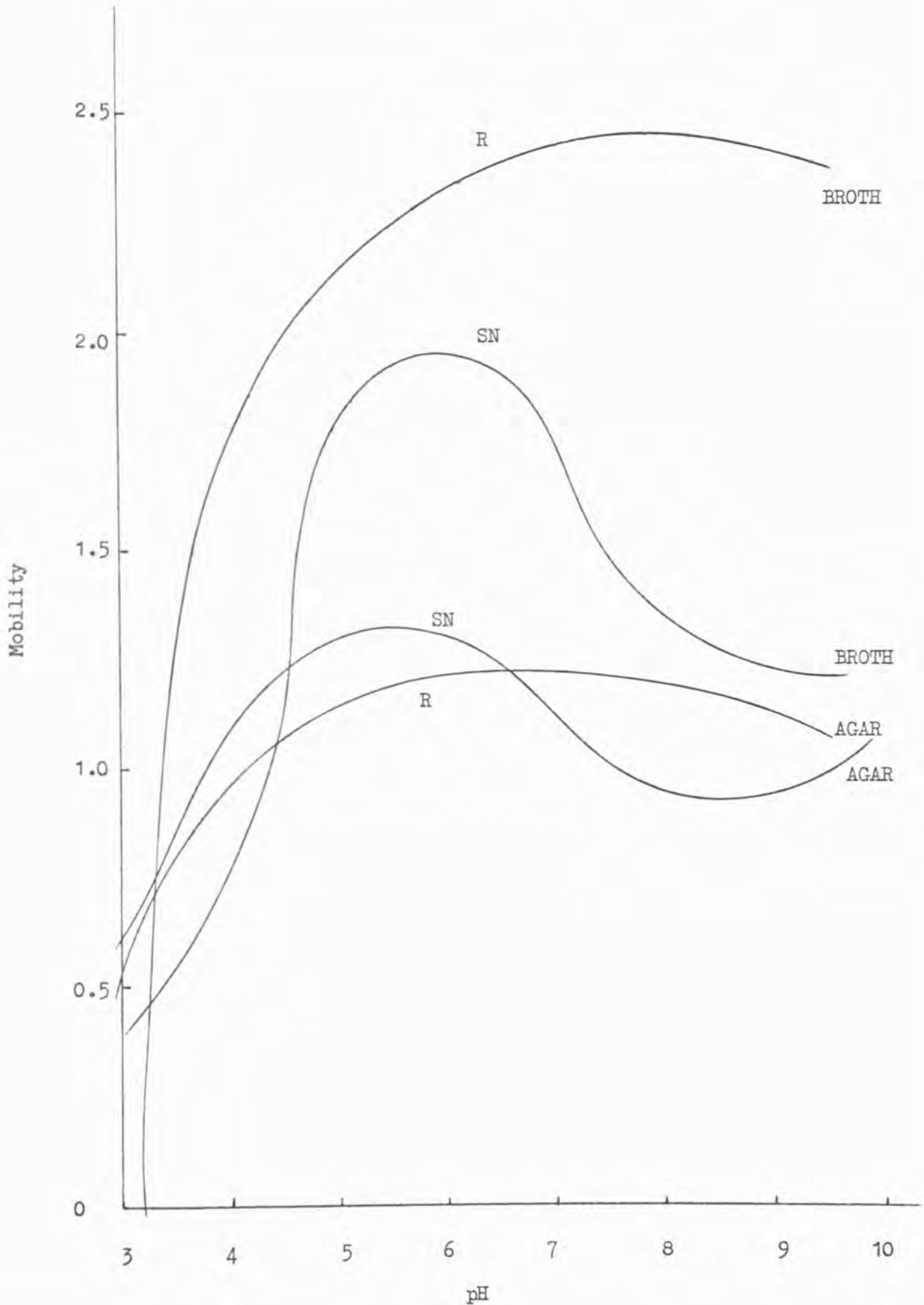

The surface lipid content (S-value) of cells of P. aeruginosa is obtained from the increase in negative mobility of cells suspended in a low concentration of sodium dodecyl sulphate (SDS). The hydrophobic hydrocarbon chain of the SDS molecule becomes aligned with surface lipid due to hydrophobic interactions leaving the hydrophilic (sulphate) polar head group protruding from the surface thereby increasing the cell surface negative mobility. (Dyar, 1948).

$$S = \frac{(\bar{v}_{\text{SDS}} - \bar{v})}{\bar{v}} \times 100$$

where  $\bar{v}_{\text{SDS}}$  is the mobility value in the presence of SDS ( $10^{-4}$  mol dm $^{-3}$ ) and  $\bar{v}$  is the mobility value in buffer solution alone. An S-value > 10 is indicative of the presence of surface lipid.

A typical gentamicin-sensitive strain of P. aeruginosa exhibited a wave-shaped pH-mobility curve. In contrast the pH-mobility curve of a gentamicin-resistant strain increases with increase in pH usually attaining a plateau value but in some cases the negative mobility decreased at higher pH values. (cf. Pechey, 1973; Chapman, 1976).

The wave-shaped curve cannot be described in terms of dissociation of a single charged species (Lowick and James, 1957). An increasing series of negative plateau mobility values would be expected with increasing pH if the net surface charge resulted from more than one negative ionogenic species, as shown by Plummer et al., (1962) with cells of Streptococcus pyogenes. The wave-shaped curve could be the result of reorientation or rearrangement of the cell surface ionogenic groups due to pH changes, this would produce a change in the ratio of positive to negatively charged groups at

the cell surface. Pechey and James (1974), found that the surface of gentamicin-sensitive and -resistant cells of P. aeruginosa were very complex; charged carboxyl and amino groups were present. A single anionic dissociating species present on the surface of some strains was associated with  $\gamma$ -carboxyl glutamic acid, whilst the free amino groups in the cell envelope and surface of P. aeruginosa originated from lysine and L-alanine (P. Stewart, personal communication). Thus the decrease in the negative mobility value from pH 7 - 9 could be due to the exposure of such amino groups previously concealed below the electrokinetic layer, or alternatively to concealment of the carboxyl groups which had previously contributed to the surface charge.

Wave-shaped curves observed by Hill and James (1972a) for Staph. aureus are due to the rearrangement of teichoic acid molecules and thus exposure of the phosphate groups of cell-wall ribitol teichoic acid at low pH, these phosphate groups gave a maximum mobility value at pH 3.5 - 4. Surface teichoic acid is not a major constituent of the cell envelope of gentamicin-sensitive cells of P. aeruginosa. Oxidation with periodate had no <sup>such</sup> effect on the shape or position of the pH-mobility curves (Pechey and James, 1974). Thus the shape of the pH-mobility curve of gentamicin-sensitive cells is not due to reorientation of surface teichoic acid.

Pechey (1973), Pechey et al., (1974) and Chapman, (1976) have shown that gentamicin-sensitive strains of P. aeruginosa are characterised by low MIC values ( $< 12 \mu\text{g cm}^{-3}$ ), SN-shaped pH-mobility curves and low S-values. Gentamicin-resistant strains, with intrinsic resistance to gentamicin, have MIC values  $> 12 \mu\text{g cm}^{-3}$ , R-shaped pH-mobility curves and S-values greater than 10. However,

cells of strains possessing resistance due to the presence of R-factors only exhibit SN-shaped pH-mobility curves and have low S-values.

The results of the pH-mobility curves, MIC values and surface lipid content are summarised in Table 9.1.

Cells of *P. aeruginosa* sensitive to gentamicin exhibit pH-mobility curves with high W-values, MIC values  $< 12 \mu\text{g cm}^{-3}$  and S-values  $< 10$ ; in contrast, strains with intrinsic resistance to gentamicin show R-shaped pH-mobility curves ( $W=0$ ), MIC values  $> 12 \mu\text{g cm}^{-3}$  and, in general, significant amounts of surface lipid (S-values  $> 10$ ) (with the exception of strains 100 and 104, to be discussed later). The strain possessing R-factor resistance (Capetown) after growth at  $37^{\circ}\text{C}$  either on agar or in broth showed an SN-shaped pH-mobility curve, in confirmation of previous findings.

The surface properties and MIC values of the gentamicin-sensitive strain 1 were not significantly affected by changes in the growth temperature, with one exception; the pH-mobility curves were similar in shape, but as the temperature was raised the curves were displaced vertically indicating increased negative mobility. This phenomenon was only observed when sensitive cells were grown in broth, but was still apparent after twenty subcultures, and was not accompanied by any change in MIC. A comparison of the pH-mobility curves of all strains grown in broth showed a smaller number of ionogenic groups at the surface of sensitive cells grown at 25 and  $37^{\circ}\text{C}$ . These ionogenic groups are probably involved in the transport of metabolites and in the antigenic properties of the cell and it is unlikely that the cell envelope of sensitive cells has a smaller number of such groups. However, at the physiological growth temperature the distribution of such groups on the surface of sensitive cells may differ from that of resistant cells.

Table 9.1. A summary of the surface properties and gentamicin-resistance of strains of *P. aeruginosa*

Test	S.C.	$\beta$	Growth Media	Strain/growth temperature °C												Capetown			
				1	100	104	Smith	PL11	25	25	25	25	25	25	25				
MIC	1	1	B1	0.2	8000	8000	4000	2500	5000	625	50	25	0.8	200	100	6.2	200	100	3
			A3	-	-	-	-	-	-	-	256	512	64	512	512	64	256	512	64
MIC	20	20	B1	0.2	8000	8000	2000	2500	2500	2500	50	12.5	0.4	400	0.6	<0.2	100	6.2	0.8
			A3	-	-	-	-	-	-	-	512	512	128	512	32	8	512	32	16
pH- $\bar{v}$	1		B1	SN	R	R	R	R	R	R	R	R	SN	R	SN	R	R	SN	SN
W-value				34	0	0	0	0	0	0	0	0	4	0	0	29	0	10	22
pH- $\bar{v}$	1		A3	SN	R	R	R	R	R	R	R	R	SN	R	SN	SN	SN	SN	SN
W-value				24	0	0	0	0	0	0	0	0	14	0	0	39	6	27	31
D-value				24	53	49	50	54	34	34	39	54	50	44	44	10	25	34	12
pH- $\bar{v}$	20		B1	SN	R	R	R	R	R	R	R	R	SN	R	SN	-	-	-	-
W-value				38	0	0	0	0	0	0	0	0	3	0	37	32	-	-	-
pH- $\bar{v}$	20		A3	SN	R	R	R	R	R	R	R	R	SN	R	SN	SN	-	-	-
W-value				17	0	0	0	0	0	0	0	0	13	0	16	42	-	-	-
D-value				19	40	43	63	44	33	33	44	48	55	47	38	5	-	-	-
S-value	1		B1	-	<1 <sup>Y</sup>	<1	<1	2	<1	<1	2	18	<1	13	10	<1	-	-	-
			A3(0)	2	14	20	19	12	<1	<1	12	25	<1	14	11	4	-	-	-
			A3(6)	-	<1	<1	<1	11	7	7	11	28	<1	-	-	-	-	-	-
S-value	20		B1	-	-	-	-	-	-	-	-	-	-	13	<1	<1	-	-	-
			A3(0)	4	6	33	22	63	15	15	13	11	<1	27	6	<1	-	-	-
			A3(6)	-	-	40	6	<1	<1	6	-	-	-	-	-	-	-	-	-

<sup>Y</sup> pH-mobility, SN is characteristic of a gentamicin-sensitive strain, R is characteristic of a gentamicin-resistant strain;  
<sup>β</sup> number of subcultures in the absence of gentamicin; <sup>Y</sup><1, negligible surface lipid detected; <sup>δ</sup> A3(0), cells measured immediately after growth, A3(6), cells measured after a 6 month interval.

The gentamicin-resistant strains differed in their response to changes in the growth temperature. Lowering the temperature from 37 to 25°C did not significantly alter the surface properties and MIC values of the resistant strains (except the R-factor strain where the shape of the pH-mobility curve was altered). However, growth at 43°C resulted in significant changes in the surface properties of two resistant strains which correlated with changes in the MIC values. The shape of the pH-mobility curves of strains Smith and PL11 changed from R to SN (ie. increased W), surface lipid was not detectable and the MIC values were less. The MIC values of all strains grown and measured at 43°C were less than when measured at lower temperatures. Where this reduction in MIC was slight (strains 1, 100 and 104) it could be attributed to altered cell mass:gentamicin ratio, since there was a slight reduction in cell mass when cells were grown at 43°C (Fig.3.1); and/or to an increase in permease activity (active transport enzymes). However the MIC of cells of Smith, PL11 and Capetown were lower at this temperature and were gentamicin-sensitive in broth. This changed sensitivity to gentamicin cannot be attributed solely to a slight reduction in cell mass at 43°C, nor to instability of the gentamicin molecule. At an elevated temperature some chemical or physiological change appears to have taken place in the bacterial system enabling the gentamicin molecule to reach and attack the ribosomal target site of the cell more readily. At 43°C the enzymes responsible for cell growth and division are working under extreme conditions of temperature, and thus miscoding at the ribosomal site of protein synthesis could result in the formation of erroneous enzymes indirectly contributing to the greater ability of the gentamicin molecule to be transported into the cell. Loss of gentamicin resistance before repeated subculture



was a temporary phenomenon since the MIC values of these three strains grown at 43°C but measured at 25 and 37°C increased to values similar to those obtained when the strains were grown and measured at 25 and 37°C respectively.

Repeated subculture in the absence of gentamicin at different temperatures did not significantly affect the gentamicin-sensitivity or surface properties of the sensitive strain and the resistant strains possessing only intrinsic resistance to gentamicin. Any changes in the MIC values of these strains (1, 100, 104 and Smith) was not accompanied by changes in the shape of the pH-mobility curve or with changes in S-values. Repeated subculture at 37 and 43°C on agar, however, did result in significant changes in the surface properties and MIC values of the two R-factor strains (PL11 and Capetown). At 43°C there was a further reduction in MIC and at 37°C the cells were sensitive to gentamicin when measured in broth; the pH-mobility curve of strain PL11 became typical of a sensitive strain ( $W = 37$ ) and the S-value was negligible - characteristic of sensitive cells. The MIC values of cells of these two strains after repeated subculture at 37 and 43°C were not increased when measured at 25°C. The gentamicin resistance originally present in Capetown and PL11 strains appears to have been lost on repeated subculture at 37°C. This suggests that repeated subculture of strains PL11 and Capetown at 37°C results in some change or changes which are genetically transferable. In contrast, a loss of resistance in cells of the parent strains grown once at elevated temperatures, and in cells of Smith with intrinsic resistance to gentamicin is only a temporary phenomenon.

Gentamicin resistance in P. aeruginosa strains may be attributed to one or more of the following: a reduction in the ability of gentamicin to bind to its ribosomal target site as a result of an altered ribosomal structure; a reduction in the ability of gentamicin to penetrate through the cell to the ribosomes due to the presence of some barrier of resistance, such as surface lipid; a reduction in the uptake of the active gentamicin moiety at the cell surface sites because of changes in cell surface components; or due to the presence of some substance which can render the gentamicin molecule inactive - such as the R-factor drug degrading enzymes.

Three different patterns relating to the resistance properties of the cells have emerged which may be associated with surface lipid:

- (i) variations in the amount of surface lipid in strains 100 and 104 could not be correlated with changes in the growth temperature, growth media or with repeated subculture;
- (ii) the surface lipid and MIC values of cells of Smith and PL11 were reduced at elevated growth temperatures and the shape of the pH-mobility curves changed;
- (iii) repeated subculture at 37°C affected the surface lipid content of strain PL11 only - together with the MIC value and pH-mobility curve.

Thus surface lipid can be correlated with the gentamicin resistance of strains Smith and PL11 and it is also quite possible that surface lipid is involved in the intrinsic resistance of strains 100 and 104. There was, in general, no evidence of significant surface lipid when strain 104 was grown on agar or in broth, or when strain 100 was grown in broth, although these strains had high MIC values and exhibited R-shaped pH-mobility curves. After twenty

subcultures on agar at 25, 37 and 43°C significant amounts of surface lipid were present, correlating with the gentamicin-resistance of these strains. After 6 month storage, there was a marked decrease in surface lipid. Since surface lipid was not always present (although the MIC values of the cells were unaltered) it is possible that it is not involved in an intrinsic resistance mechanism. However, if redistribution of surface lipid took place this would prevent its detection by SDS treatment; and the 'surface' lipid could still play its part in the resistance mechanism. The results for these two strains, together with previous observations (Pechey, 1973; Pechey *et al.*, 1974; Chapman, 1976) suggest that redistribution, rather than loss of surface lipid occurs in both strains.

Intrinsic resistance to gentamicin in strains 100, 104, Smith and PL11 could, however, be the result of a mutation, e.g. a stable heritable change in a nucleotide sequence of genetic nucleic acid could result in the production of enzymes coding for the assembly of surface neutral lipid. Thus surface lipid could then act as a hydrophobic barrier reducing the access of the polar gentamicin molecule. Such a mutation could also produce an altered ribosomal structure, thereby making it impossible for gentamicin to bind to its ribosomal target site. Both these factors may contribute to intrinsic resistance and this might explain the very high MIC value of some resistant strains. Nomura, (1970) has proposed that streptomycin resistance is the result of lack of binding of the antibiotic to the ribosomes of resistant mutant cells.

Since surface lipid is not lost permanently in strains 100, 104 and Smith, the enzymes coding for the production of surface lipid are probably located in the chromosome. However, differences

in the efficiency of surface lipid production exist between cells of strain Smith (with low-level resistance) and cells of strains 100 and 104 (with high-level resistance) at elevated temperatures. Temporary loss of surface lipid production at 43°C only in strain Smith could suggest temporary inhibition of the enzymes responsible for surface lipid production.

Cells of the R-factor strains PL11 and Capetown became sensitive after repeated subculture at 37 and 43°C and their MIC values were not increased when these cells were tested at lower temperatures, in contrast to cells of Smith. Thus some change has occurred in cells of PL11 and Capetown as a result of repeated subculture which is genetically transferable, and the mechanism for surface lipid production in strain PL11 is probably located extrachromosomally on a plasmid.

The apparent loss of gentamicin resistance in cells of the two R-factor strains prompted an attempt to produce transconjugants by mating these two donor strains (PL11 and Capetown) with a gentamicin-sensitive, rifampicin-resistant acceptor strain (PU21) in broth at 37°C to determine whether the R-factors were transferable. Cells of strains PL11 and Capetown after growth at 37°C and after repeated subculture at 25°C on agar produced transconjugants on mating. However, transconjugants could not be produced from cells repeatedly subcultured at 37 and 43°C. Thus the R-factors of PL11 and Capetown are lost after repeated growth at 37 or 43°C rather than the cells experiencing slight thermal damage which can be repaired by growth at lower temperatures (cf. Smith).

The MIC values of the transconjugants of Capetown were similar to those of the parent strain, however, the MIC values of the transconjugants of strain PL11 were greater than those of the parent strain grown at 37°C (the temperature also used in the mating experiments) but were similar to those of the parent strain which had been grown initially at 25°C and to cells repeatedly subcultured at 25°C. These results appear to be erroneous since the MIC values of transconjugants are generally considered to be less than those of the donor strains. Chapman (1976) found the levels of resistance conferred onto the transconjugant strains during mating was always less than the original resistance of the donor; he only found evidence of the transfer of the R-factor resistance mechanism when PL11 was mated with a different acceptor strain (PL1). However, Kono and O'Hara (1975) found the MIC values of the transconjugants were similar to the donor strains; they stated that it is extremely unlikely that the results could be explained on the basis of a mutation of the recipients. The results of the present work and those of Chapman (1976) and Bryan *et al.*, (1974) show the need for using a range of P. aeruginosa strains as recipients in the survey of R-factors.

Large increases in the MIC of transconjugants could be due to transfer of the enzymes coding for the production of surface lipid in addition to the transfer of R-factors. Experiments have already shown that such enzymes are probably located extrachromosomally on a plasmid. It is therefore possible that both mechanisms of resistance in strain PL11 are transferred on conjugation on a plasmid and it is possible that they are carried on the same plasmid. These results, if confirmed, could have serious clinical implications; however, this hypothesis needs further investigation.

Kono and O'Hara (1975) observed the transfer of more than one resistance determinant in some R-factor strains and Korfhagen *et al.* (1975) identified *P.aeruginosa* R-factors with efficient transfer of enhanced resistance to antibiotics and mercury ions from urinary tract infections.

This loss of gentamicin resistance and apparent loss of R-factors on repeated subculture of cells of PL11 and Capetown at 37 and 43°C is interesting since these strains have already been tested frequently at 37°C in this laboratory, and stored at 4°C. Possible explanations for the loss of the R-factor mechanism of resistance include the use of different media (agar A3) to store and subculture the strains, [Pechey (1973) and Chapman (1976) used a solid media made from Oxoid nutrient broth No. 2 and Oxoid nutrient agar No. 1]; repeated subculture at certain temperatures which may play some role in the loss of R-factors.

Thus changes in the growth temperature, growth media and repeated subculture probably influence the loss of resistance present in PL11 and Capetown. A study of the R-factor strains, by subjecting them to variations in the above conditions, might help to elucidate the mechanism or mechanisms involved in the loss of R-factors.

Methicillin-resistant strains of *Staph. aureus* are similarly affected by changes in the above factors (Davies and James, 1974, James and Al-Salihy, 1976).

The pH-mobility curves exhibited by cells grown on agar and in broth are similar in shape (except Capetown grown at 25°C) but there is a marked reduction in the mobility of all strains grown on agar at all growth temperatures compared with those of cells grown in broth; the D-values were large (except Capetown and PL11 grown at 43°C). After repeated subculture large differences between

the mobility of cells grown on agar and those grown in broth were again observed, although the shape of the pH-mobility curves were unaltered; i.e. large D-values.

Cells of the R-factor strains exhibited a very high mobility value at pH 6 when grown on agar at 43°C; they correspondingly had low D-values. The populations of cells of strains 1, 100, 104 and Smith were electrokinetically heterogeneous when measured at pH 6 and 7 after growth on agar at 43°C (Fig. 3.2). This phenomenon could be the result of enzyme activity, suggesting that metabolic processes are still taking place within the cell. Since the decrease in negative mobility values of cells grown on agar is attributed, at least in part, to the uptake of divalent metal ions at the cell surface, (see later) it is feasible that these divalent metal ions have been released as a result of enzymic processes exposing negatively charged ionogenic groups, thus increasing the negative mobility.

A disparity was also found between the MIC values of cells grown on agar and those grown in broth, the MIC was always greater on agar (A3) than in broth (B1). Gilbert *et al.* (1971) reported that the MIC of gentamicin for *P. aeruginosa* was increased when the calcium or magnesium contents of the medium were raised. A 32-fold variation in the sensitivity of *P. aeruginosa* to gentamicin was dependent upon the media constituents and the type of media used (Garrod and Waterworth, 1969).

Thus cells grown on agar appear to possess some factor which increases their resistance to gentamicin. Cells of Smith and PL11, when grown on agar at 43°C, had MIC values  $> 12 \mu\text{g cm}^{-3}$  but the pH-mobility curves were typical of a sensitive strain and S-values were low. Thus this additional factor present in cells of these

strains grown on agar (A3) at this elevated temperature could not be correlated with surface lipid or with the shape of the pH-mobility curve.

The altered MIC values and surface properties of cells grown on agar are not permanent; the gentamicin-sensitivity patterns are fully reversed when these cells are regrown in broth. Chapman (1976) similarly found no permanent change in the antibiotic characteristics of cells grown on media containing excess calcium ions. These observed changes were a direct result of changes in the growth media used, and were not genetically transferable. Thus the increased MIC values of cells grown on agar could be attributed to temporary changes in the structure of the cell envelope preventing uptake and/or transport of gentamicin to its ribosomal site of action.

A study was undertaken to determine the factors affecting the different mobility values of cells grown on agar or in broth. The experimental techniques used were such that any variations in mobility due to the preparation of cells for test, the nature of the suspending medium, and the conditions of measurement were excluded i.e. cells grown on agar (A3) or in broth (B1) were prepared for electrophoretic mobility measurements and tested under identical conditions. Thus differences in the environmental growth conditions of cells grown on agar compared with cells grown in broth, which could be responsible for the observed mobility changes, appeared to be related to variations in the constituents of the growth media and state of the medium (i.e. liquid or solid). It is unlikely that the state of the medium would contribute to such changes in mobility since Chapman (1976) found that the electrokinetic properties of *P. aeruginosa* are not affected by the state of the medium. The agar medium used (A3) contained agar



No. 3 in addition to those constituents present in the broth (B1)(Table 2.4). Agar No. 3 had a very high content of divalent metal ions (Table 6.2 ). The antimicrobial action of gentamicin on *P. aeruginosa* is dependent on the growth medium; the presence of excess magnesium and calcium ions greatly affecting resistance (Garrod and Waterworth, 1969; Gilbert et al., 1971; Zimelis and Jackson, 1973). Thus any changes in the mobility value which could be attributed to the divalent metal ion content of the media could also be related to the observed increase in the MIC value of cells grown on such media.

Cells grown on agar and in broth exhibited pH-mobility curves which were similar in shape although cells grown on agar had significantly lower negative mobility values (Fig 9.1.). This suggests that the cell surface components responsible for the shape of the pH-mobility curve are still present on the surface of cells grown on agar, but that some factor or factors are responsible for the decrease in the negative mobility value of cells grown on agar. These could be a reduction in the synthesis of the groups responsible for the shape of the pH-mobility curve; increased production of certain components of the cell envelope such as polysaccharide, which associates with, or blocks these ionogenic components; association of other ionogenic groups, such as divalent metal ions, with the cell surface.

Cells of Smith and 104 grown on agar had a much higher polysaccharide content than when grown in broth (50%); there was also a slight decrease in protein content. These results are in agreement with those of Chapman (1976) who showed that cells grown on calcium-sufficient media had an increased polysaccharide and slightly decreased protein content. There was a slight increase in polysaccharide and protein content for cells of PL11 grown on agar.

Variations in the protein and polysaccharide content could be the result of both redistribution and/or reorientation of cell envelope constituents, which may cause a change in the overall surface charge. Since similar reductions in the mobility values of cells of these strains occurred when grown at 37°C but their protein and polysaccharide content differed, it is unlikely that the observed changes in protein and polysaccharide are solely responsible for the reductions in the mobility values.

Although quantitative changes in the protein content of cells grown on agar compared with cells grown in broth were not large, it is possible that significant qualitative changes in the amino acid content has occurred which could subsequently affect the cell surface charge. Gilleland *et al.* (1974) found qualitative but not quantitative differences in the protein content of cell envelopes grown in magnesium-sufficient and -deficient media.

Surface lipid (S-value) could not be related to the differences between the mobility values of cells grown on agar or in broth. It is also unlikely that phospholipid contributes to the surface charge of cells grown on agar since the first maximum mobility occurs at approximately the same pH for cells grown in broth and on agar, and agreed with that observed by Pechey and James (1974), who showed that phosphate groups do not contribute to the cell surface charge of *P. aeruginosa*. If ionizable phosphate groups from phospholipid were present on the cell surface then the first maximum mobility should have occurred at a lower pH (cf. *Staph. aureus*, Hill and James, 1972a,b)

The large difference in the cation content of the two media may give rise to the different mobility values of cells grown on agar and in broth as well as determining their 'apparent' resistance to

gentamicin. The concentrations of the divalent metal ions calcium, magnesium, iron and zinc were greater in the agar medium (A3) than in broth (B1); the calcium content of the agar was significantly greater than that of the other metal ions. The divalent metal ion content of both growth media was in excess of that necessary to cause phenotypic variation ( $< 10^{-2} \text{ mmol dm}^{-3}$ ) (Melling and Brown, 1975).

The total divalent metal ion content (magnesium, calcium, iron and zinc) of resistant and sensitive strains grown in broth was similar (Chapman, 1976). The divalent metal ion content of cells grown in broth was, therefore, not related to differences in resistance to gentamicin, although distribution of these metal ions throughout the cell might vary between resistant and sensitive strains.

The divalent metal ion content of resistant and sensitive strains grown on agar was greater than that of cells grown in broth; this increase was much greater for sensitive cells. The magnesium content of resistant and sensitive cells grown in both media was similar, although agar contained much greater amounts of magnesium than did broth. The higher divalent metal ion content of cells grown on agar was mainly attributed to the increase in the calcium content, and this was much greater in sensitive than resistant cells. Cells of the resistant strain, in contrast to cells of the sensitive strain, possessed larger amounts of magnesium than calcium ions. Since growth of cells of *P. aeruginosa* is inhibited by the presence of excess quantities of iron and zinc (Chapman, 1976) the fact that the cellular content of these two ions is not increased in all cells is not unexpected.

To establish whether the increase in the divalent metal ion content of cells (in particular sensitive cells) grown on agar was related to changes in the composition of the cell envelope and cell surface, experiments using EDTA were undertaken. EDTA, a chelating agent for divalent metal ions, has been widely used in studies on cells of *P. aeruginosa*; the mechanism of action for the toxicity of EDTA has not been fully elucidated, but it would appear that the primary step is the chelation of essential metal cations from the cell wall (Gray and Wilkinson, 1965a; Roberts *et al.*, 1970; Haque and Russell, 1974). This is followed by the dissociation and partial solubilization of the outer membrane (Wilkinson, 1975). Eagon and Carson (1965) found that calcium was chelated in greatest quantities by EDTA, whereas magnesium is the essential cation removed from the cell wall. Cox and Eagon, (1968), Gilleland *et al.*, (1973) have shown that the extraction of divalent metal ions by EDTA released other cell wall components; the EDTA-extract contained lipopolysaccharide, protein and lipid loosely associated in a complex or series of complexes; however, peptidoglycan was not released.

A study of lysis by EDTA of cells of gentamicin-sensitive and -resistant strains was undertaken at pH 8.6. Lysis of cells grown in calcium-sufficient media is more rapid than that of cells grown in calcium-deficient media (Chapman, 1976). Cells of resistant and sensitive strains grown in broth were lysed at the same rate; similarly these cells grown on agar lysed at the same rate. However, the rate of lysis of agar-grown cells was markedly greater than that of broth grown cells. (Fig 7.1).

If the primary step of EDTA-lysis is metal ion chelation the more rapid lysis of cells grown on agar, compared with those grown

in broth is expected, since the divalent metal ion content of agar-grown cells is greater. However, sensitive cells grown on agar have a greater divalent metal ion content than resistant cells grown on agar, but they lyse at a similar rate.

A possible explanation for this phenomenon is that removal of divalent metal ions by EDTA, which results in the release of cell wall components, opens areas in the cell envelope through which lysozyme can penetrate and attack its peptidoglycan substrate; the number of such areas, rather than the divalent metal ion content, being the critical factor in determining the rate of lysis. It is also possible that not all divalent metal ions removed by EDTA, and present in the cell envelope, are associated with those cell wall components, which on extraction open up areas for potential lysozyme penetration. The slower lysis of cells grown in broth could therefore be due to the exposure of a smaller number of such areas susceptible to lysozyme; a contributory factor to slower lysis may be the differences in the structure of the cell wall components of cells grown in broth. A similar rate of lysis of cells grown on agar could be explained by the exposure of a similar number of these areas after EDTA treatment, although the divalent metal ion content of the cells differed.

Cells of P. aeruginosa were washed with subinhibitory concentrations of EDTA to remove any divalent metal ions associated with the cell surface. The mobility values of both gentamicin-resistant and -sensitive strains grown on agar became more negative and these compared to those of the control strains grown in broth. Thus the association of divalent metal ions with cell surface components appears to be a contributory factor in the lower mobility values of resistant and sensitive cells when grown on agar. In contrast, the

mobility values of cells grown in broth were not significantly affected by similar EDTA treatment, suggesting that divalent metal ions play a less significant role on the surface of such cells. The lower mobility values of agar-grown cells could also be partly attributed to the presence of a higher polysaccharide content in the cell envelope. Thus divalent metal ions (probably calcium) bind with the negative ionogenic groups at the surface of agar-grown cells; divalent metal ions may also be associated with the polysaccharide component.

Calcium is not irreversibly bound to the surface of cells of *P. aeruginosa* when these cells are suspended in a buffer solution containing excess calcium (Chapman, 1976). The present results indicate that calcium ions were bound to the cell surface during growth on agar, and were not removed by washing. Thus the association of calcium with the cell wall is a more complex process occurring during growth, possibly mediated by enzymes, and is not a simple physical adsorption. Brown and Melling (1969b) have shown that the addition of magnesium ions to the growth media increased the sensitivity of cells to EDTA (and polymyxin). Addition of magnesium ions after growth had ceased had no effect; thus magnesium has to be present during active cell division. If the complex process of attachment of divalent metal ions to the cell surface during growth is enzymically mediated, it is unlikely that these enzymes are highly specific for calcium ions.

Although both calcium and magnesium ions were present in excess in the growth media, the calcium content of the organisms was greatly increased in preference to the magnesium content when resistant and sensitive strains were grown on agar (A3). However, magnesium is the cation essential for cell synthesis and metabolism, these ions being required preferentially for RNA synthesis, after

which they can be utilized for other purposes such as their structural role (Brown and Melling, 1969b). Several factors may influence the differential uptake of calcium and magnesium ions by the cell surface. Selection is dependent upon the concentrations of the competitor metal ions and their stability constants. The amount of divalent metal ion bound is proportional to the product of the concentration of this ion and the logarithm of its stability constant (Fraústo da Silva and Williams, 1976).  $\log K_M$  of magnesium and calcium ions does not vary greatly for carboxylate, phosphate or sulphate binding centres; thus selection usually rests upon the concentration term. In the present work the calcium concentration of the agar (A3) exceeds that of magnesium; this suggests that calcium uptake would be favoured.

From a consideration of the stability constants, Fraústo da Silva and Williams showed that calcium and magnesium ions have a preference for carboxylate and phosphate groups; magnesium is taken up preferentially by phosphate ligands and calcium by polycarboxylate ligands. Since carboxylate and phosphate groups are present in the cell envelope of *P. aeruginosa* the surface charge could be due to both these ions. Phosphate groups are important in the binding of magnesium and other cations to cell envelope components such as lipopolysaccharide (Costerton *et al.*, 1974). However, Pechey and James (1974) showed that the negative surface charge of strains 1 and 100 probably originates from the  $\gamma$ -carboxyl group of glutamic acid located at the cell surface. This is consistent with the observed greater uptake of calcium than magnesium ions in cells grown on A3 media. Consideration of the above factors enhances the probability of calcium ions binding to cell surface negative ionogenic groups and consequently reducing the negative mobility value of cells grown on agar.

Although both resistant and sensitive strains of P. aeruginosa grown on agar take up greater amounts of calcium ions than when grown in broth, the gentamicin-sensitive strain 1 contained seven times more calcium than did the gentamicin-resistant strain 100. The negative mobility values of cells grown on agar and the results from treatment with EDTA have shown that similar amounts of divalent metal ions are present on the surface of resistant and sensitive strains grown on agar. This suggests much larger amounts of calcium ions are distributed throughout the cells of sensitive than those of resistant strains grown on agar. It is interesting to speculate that differences in the ability of these strains to take up calcium ions is related to the difference in their ability to accumulate gentamicin. The presence of greater amounts of hydrophobic lipid in the cell envelope of resistant strains could be a contributory factor in the reduction of the number of possible calcium binding sites, and in the reduced efficiency of the gentamicin transport mechanism in the resistant cell.

It is apparent that divalent cations are associated with the surface of cells of P. aeruginosa grown on agar containing large amounts of these ions. The possibility that gentamicin is similarly associated with the cell surface was therefore explored, as was whether competition occurred between divalent metal ions and gentamicin for sites on the cell surface.

The mobility values of cells of resistant strains grown in broth in the presence of sub-inhibitory concentrations of gentamicin were significantly lower than the control cells grown in broth in the absence of gentamicin. There was a 10% reduction in the mobility value of cells of the gentamicin-sensitive strain, which could be considered significant. It could be that the fraction of gentamicin binding



to the surface of sensitive cells was small (under the subinhibitory concentrations of gentamicin used) because the gentamicin molecules are transported unhindered through the cell envelope to the cytoplasmic ribosomal site. The reduced mobility shown by the two resistant strains grown in broth in the presence of gentamicin, however, suggests that the gentamicin molecule interacts with the surface to alter the overall total ionogenic charge. Therefore intrinsic resistance to gentamicin does not appear to be due to the inability of the cell to accumulate gentamicin at the cell surface, but rather to the inability of the gentamicin molecule to be transported to and accumulated at the ribosomal site. This binding of gentamicin to the cell surface of P. aeruginosa would appear to be the first step in the antibacterial action of gentamicin.

The negative mobility values of cells of P. aeruginosa suspended in a solution containing gentamicin were lower than those of the control (Pechey, 1973); however, washing removed the gentamicin and the mobility of the washed cells increased to that of the control. It was postulated that the decrease in mobility was due to reversible adsorption on the surface, or to specific ion-pairing of the amino groups of the gentamicin molecule with the carboxyl groups of the cell surfaces. The reversibility of this attachment was purely a physical phenomenon. This contrasts with the effects observed in this work when cells were grown in the presence of gentamicin; thus there must be an active mechanism occurring during growth in which gentamicin is taken up at the cell surface to alter the surface ionogenic charge. Therefore the association of gentamicin, as well as calcium, at the cell surface appears to be a complex process occurring only during active growth

and is possibly enzymically mediated. It is unlikely that there are specific enzymes present in the cell that interact with the gentamicin molecule, it is more likely that some part of the gentamicin molecule rather than the whole resembles a substrate of an active enzyme system required by the cell.

When resistant and sensitive strains were grown on agar containing large amounts of calcium ions the decrease (50%) in mobility values was approximately the same as that for these cells grown on agar containing large amounts of calcium plus gentamicin; thus gentamicin does not bind significantly to the surface of cells grown on agar (A3). It would appear that when large amounts of divalent metal ions are present in the growth media association of gentamicin with its cell surface sites is prevented, probably because these sites are either occupied or blocked by the formation of a metal ion induced resistance barrier.

The formation of a weak 1:1 calcium-gentamicin complex has been observed (Chapman, 1976), and it is possible that the formation of such a complex rendered the gentamicin molecule inactive; this would effectively reduce the concentration of free gentamicin available and hence raise the MIC. In the present experiments the molar concentrations of calcium and gentamicin in the agar used to grow strain 100 were approximately equal. If such an inactive gentamicin/calcium complex was formed it would probably not associate with the cell surface. However, the large decrease in mobility values of cells grown on agar plus gentamicin, which is similar to those obtained in the absence of gentamicin, demonstrates that some form of association of divalent metal ions with the cell surface takes place. Since the antagonism of the antibacterial action of gentamicin by divalent metal ions is species-specific for *P. aeruginosa* and related species only, inactivation of gentamicin by the formation of a gentamicin-calcium

complex would seem unlikely.

Since both calcium and magnesium ions have been shown to antagonise the antibacterial activity of gentamicin (Chapman, 1976), while calcium can replace magnesium affecting the sensitivity of P. aeruginosa to EDTA (Brown and Melling, 1969a,b) it is therefore, reasonable to assume that magnesium could fulfil a similar function when present in excess and calcium in limited supply in the growth medium. Thus the differential uptake of magnesium from the agar by the cell could occur, since these ions are present in large amounts, if the calcium content was reduced by the formation of a gentamicin-calcium complex, resulting in reduced mobility values.

These results suggest that the gentamicin molecule does not compete with calcium for the initial cell surface binding sites, when calcium is present in large amounts in the growth media. This appears to be further substantiated by the fact that the decrease in mobility values of strain 100 (where the concentration of gentamicin is similar to the calcium content of the agar) were similar for cells grown on agar alone, or in broth containing sub-inhibitory concentrations of gentamicin.

There are several theories regarding the increased resistance to gentamicin for cells of P. aeruginosa in the presence of large amounts of these divalent metal ions. The possibility of the formation of a weak 1:1 complex of gentamicin and calcium has already been discussed. Rameriz-Ronda et al. (1975) states that enhanced in vitro resistance of P. aeruginosa to gentamicin in the presence of high concentrations of magnesium and calcium ions is associated with decreased binding of gentamicin to P. aeruginosa and proposed that the initial binding site is the bacterial cell wall. Zimelis and Jackson (1973) compared the antagonistic effects of magnesium and calcium cations on whole cells and spheroplasts of P. aeruginosa.

These ions did not antagonise the action of gentamicin for spheroplasts, and they similarly concluded that the antagonistic species-specific effect of calcium and magnesium ions for gentamicin against P. aeruginosa appeared to be the bacterial cell wall. They could not find any inactivation of gentamicin in the presence of excess calcium and magnesium salts. All evidence suggests that the antagonistic effect of divalent metal ions against gentamicin is located at/in the cell wall as a result of a metal ion induced barrier of resistance. Furthermore, strains of Staph. aureus do not appear to have altered antibiotic resistance or surface properties which can be related to calcium uptake (Figs. 8.1a,b; Table 8.9) in contrast to P. aeruginosa. Thus the metal ion induced species-specific antagonism of the antibacterial action of gentamicin on cells of P. aeruginosa is a surface phenomenon.

The antagonism of the antibacterial action of gentamicin by divalent metal ions (Garrod and Waterworth, 1969) and the toxic action of EDTA is species-specific for P. aeruginosa and some related species; Esch. coli and other coliform bacteria are not lysed under the conditions which are toxic to P. aeruginosa (Lieve, 1968). Resistant and sensitive strains of P. aeruginosa either possess or are able to produce some mechanism or mechanisms (possibly enzymically mediated) responsible for this species-specific phenomenon which are lacking in other Gram-negative bacteria. From data presented here, this species-specific effect is due to the formation of a metal ion induced resistance barrier as a result of the accumulation of divalent metal ions at the cell surface and the increase in the polysaccharide content of the cells, but only when divalent metal ions are present in large amounts in the growth media.

This metal ion induced resistance barrier may prevent the accumulation of gentamicin at the cell surface sites, either by blocking or occupation of these ionogenic sites.

Colobert (1958) and Asbell and Eagon (1966a,b) found that EDTA removed or combined with divalent metal ions which were bound to the cell wall and were essential for its structural integrity. Divalent metal ions help to stabilize the outer membrane by linking lipopolysaccharide and lipoprotein via phosphate groups (Costerton et al., 1974). Repaske (1958) reported that the uptake of divalent metal ions by the cell wall interfered with the formation of the lysozyme-substrate complex. Salton (1958) and Noller and Hartsell (1961a,b) proposed that EDTA disorganised the lipoprotein layer which overlies and protects the peptidoglycan substrate of lysozyme (Weidel et al., 1960; Rogers et al., 1969). Whereas this bound lipoprotein can account for more than 40% by weight of the rigid layer of Esch. coli it is far less prominent in the corresponding layer of P. aeruginosa (Martin et al., 1972). It is possible that such a reduction in cell envelope lipoprotein might be a factor contributing to the species-specific effect of divalent metal ions on cells of P. aeruginosa.

Thus it is evident that divalent metal ions increase the structural rigidity of the cell envelope of P. aeruginosa, at the same time enhancing the gentamicin resistance properties of the cell. This more rigid cell envelope would protect the peptidoglycan substrate from lysis by lysozyme. Treatment with EDTA and the removal of divalent metal ions made P. aeruginosa more susceptible to several antibiotics, including gentamicin, penicillin and ampicillin (Ramirez-Ronda et al., 1975). A further study of the metal ion induced species-specific gentamicin resistance effect, which apparently takes place at the cell surface of P. aeruginosa strains, would be profitable. The comparison of P. aeruginosa with another Gram-negative species, e.g. Esch. coli where gentamicin-sensitivity

is not antagonised by divalent metal ions, might help to elucidate the factors involved in this species-specific effect. Suggestions for experimental work would include the identification of the surface ionogenic groups responsible for the accumulation of gentamicin and calcium; confirmation of the presence of specific enzymes in P. aeruginosa strains which code for the uptake of divalent metal ions at the cell surface and their identification, and the measurement of cell envelope constituents (protein, polysaccharide, lipid, phosphate, sulphhydryl groups) in the presence or absence of large amounts of divalent metal ions in the growth media.

Streptomycin and gentamicin accumulation by Esch. coli and P. aeruginosa is by multiphase kinetics (Bryan and Van Den Elzen, 1975, 1976). Gentamicin cellular entry is an active process composed of at least three kinetic components (Bryan et al., 1976). The first ionic binding phase is similar in each of the resistant and sensitive strains. Second phase accumulation, however, does not begin for the resistant strain until a much higher concentration of the antibiotic than that necessary for second phase accumulation in the sensitive strain. A major explanation for resistance seems to be a requirement for an increased gentamicin concentration to initiate second phase transport. The actual mode of transport is unknown but it is proposed that the transport mechanism for gentamicin has a reduced affinity for, or access to gentamicin in resistant strains. These strains showed a marked reduction in energy-dependent accumulation of gentamicin.

In summary, gentamicin-resistant and-sensitive strains of P. aeruginosa have higher MIC and lower mobility values when grown on agar irrespective of the growth temperature or number of subcultures.

The increase in the divalent metal ion content of cells grown on agar is mainly attributed to the increase in the cellular calcium content; the cells also contain larger amounts of polysaccharide. The increased MIC values may be due to the formation of a metal ion induced barrier at the cell surface during growth. Some form of binding (not physical) of calcium ions (possibly enzymically mediated) to the negative ionogenic groups at the cell surface and to other cell wall components such as the large amounts of polysaccharide synthesized by cells grown on agar probably occurs. This metal ion induced barrier prevents the initial accumulation of gentamicin at the cell surface probably by blocking or occupying those ionogenic surface groups required by gentamicin. This initial 'primary phase' accumulation occurs in both sensitive and resistant strains. When a certain 'critical' concentration of gentamicin is present in the growth media, gentamicin accumulates at the surface of cells grown on agar, possibly as a result of a concentration gradient effect, and the metal ion induced resistance barrier is eventually overcome. The reduction in the mobility values of cells of strain 100 grown on agar plus gentamicin, compared with those cells grown on agar alone could be significant. This could indicate gentamicin accumulation at the cell surface due to such a critical concentration of gentamicin in the growth medium.

The concentration of gentamicin required to promote secondary phase accumulation is probably different in resistant and sensitive strains and related to the intrinsic resistance of the cell. Once gentamicin has accumulated at the cell surface of sensitive strains it can be transported to the ribosomal site. Cells resistant due to the presence of an intrinsic resistance barrier, which could probably be related to surface lipid, require a much greater concentration of gentamicin at the cell surface than sensitive strains before secondary phase accumulation of gentamicin can take place.

The experiments undertaken on a selection of strains of Staph. aureus of animal and human origin are summarized in Table 9.2. The animal strains were, in general, antibiotic sensitive, although approximately half contained a  $\beta$ -lactamase conferring resistance to penicillin G. The antibiotic resistance/sensitivity patterns were not significantly affected by changes in the growth temperature or growth media. Exceptions were the well established heterogeneous response to methicillin of 13136, and two poultry strains which lost their penicillin resistance on growth at elevated temperatures. It is well known that the antibacterial activity of tetracycline, both in vitro and in vivo, is reduced in the presence of calcium, magnesium and other divalent metal ions (Price et al., 1957a,b; Rosenblatt et al., 1966), thus the observed reduction in the zones of inhibition by tetracycline on A4 compared with A1 media is probably the result of the large excess of calcium in agar A4.

Novick (1963) and Dyke et al. (1970) showed that the genes determining the production of penicillinase by the majority of strains of Staph. aureus are located extrachromosomally on a plasmid. Asheshov (1966) and Poston (1966) described a number of strains in which the penicillinase gene appears to be integrated into the chromosome. The plasmid-borne penicillinase of some strains of Staph. aureus is temperature-sensitive after one subculture at 42°C (Johnston and Dyke, 1971). The present results showed that the poultry strains F2 and F4 became penicillin-sensitive after one subculture at 43°C. This suggests that the gene controlling penicillinase production in these two strains is plasmid-borne. Loss of resistance at 43°C could be due to the inability of the plasmid to divide and separate into daughter cells. The penicillinase enzyme in 13136 is plasmid-borne and James and Al-Salihy (1976) demonstrated that irreversible loss of this penicillinase plasmid



Table 9.2. A summary of the surface and biological properties of animal and human strains of *Staph. aureus*

Test	Growth Temp/°C	Metal ion	Strains													
			C1	C3	F2	F3	P1	P3	P4	13136	9541	Oxford				
metal ion resistance	37	Cd	S	S	S	MS	S	S	S	S	S	R	R	S <sup>δ</sup>	R	
		Asa	R	R	R	R	R	R	R	R	R	R	R	R	R	R
phage-type (group)	37	PhHg	MS	S	MS	S	MS	S	MS	S	S	S	S	S	S	S
		Mg/Zn/Cu	R	R	R	R	R	R	R	R	R	R	R	R	R	R
antibiotic resistance	37		I	I/III/III/misc.	NT	NT	II	I/misc.	I/misc.	I/misc.	I/misc.	III	III	I	I	
			S	PG	PG	PG	S	S	PG	PG	PG	R	R	S <sup>γ</sup>	S	
penicillinase	37		pen <sup>-</sup>	pen <sup>+</sup>	pen <sup>+</sup>	pen <sup>+</sup>	pen <sup>-</sup>	pen <sup>-</sup>	pen <sup>-</sup>	pen <sup>+</sup>	pen <sup>+</sup>	pen <sup>+</sup>	pen <sup>+</sup>	pen <sup>-</sup>	pen <sup>-</sup>	
			D	A	X	X	D	A	A	A	A	A	A	A	A	
H-value	37		-3	20	45	53	13	15	15	60	60	92	92	-	-	
			6	26	26	15	4	17	17	15	15	33	33	-	-	

<sup>α</sup> antibiotic resistance: S, sensitive to PG, Mt, Sm, E, Tc, Cm; PG, resistant to PG, sensitive to Mt, Sm, E, Tc, Cm;  
R, resistant to PG, Mt, Sm, Tc, sensitive to E, Cm; <sup>δ</sup>R, AI; <sup>ε</sup>Tc R, AH;  
<sup>β</sup>X, shape of pH-mobility curve not classifiable; <sup>γ</sup>Al-Saliby (1975)

occurred in cells of 13136 after repeated subculture at 43°C. However, neither cells of 13136 nor those of the remaining penicillinase-producing animal strains became penicillin-sensitive after one subculture at 43°C. Further work, such as repeated subculture of these cells at elevated temperatures, would be required to fully elucidate the site of the penicillinase-producing gene in these strains.

Magnesium, zinc, copper and arsenate ions did not inhibit growth of strains of Staph. aureus of human and animal origin. Methicillin-resistant 13136 was not inhibited by phenylmercury ions, whereas all other strains were inhibited. Changes in the growth media did not affect the inhibition patterns of these ions. Methicillin-resistant and -sensitive strains were resistant to cadmium. However, cells of methicillin-sensitive 9341, although resistant to cadmium when grown on the untreated agar A1, were cadmium-sensitive on the phosphate-depleted agar A4, as were the animal strains. It could be that sensitivity of 9341 to cadmium is masked by the presence of large amounts of inorganic phosphate in agar A1. Decreased availability of cadmium ions, by the formation of cadmium phosphate ( $K = 10^{32.6}$ , Sillén and Martell, 1964), could produce the apparent resistance of 9341 to cadmium ions on the phosphate-rich A1 media. Cells of K. aerogenes grown in a phosphate-limited media were very sensitive to cadmium (Pickett and Dean, 1976).

Dyke et al. (1970) found resistance to cadmium in some strains of Staph. aureus was chromosomal and not linked to penicillinase, whereas Grubb and O'Reilly (1971) and Kondo et al. (1974) found cadmium resistance was extrachromosomal and linked to penicillin resistance. The antibiotic-sensitive strain Oxford does not contain a penicillinase plasmid, thus resistance to cadmium and arsenate ions in this strain

is by some other mechanism; the possibility of a chromosomal loci for this resistance cannot be ignored. A strain of Staph. aureus (which was isolated in a hospital) of phage-type 52A/79 exhibited resistance to cadmium and arsenate ions, but was sensitive to mercury (Dyke et al., 1970). The phage-type and metal ion resistance pattern is compatible with Oxford; however, no such correlation between phage-type and metal ion resistance was found with the animal strains.

Many workers have correlated plasmid-borne penicillinase production with resistance to metal ions (Richmond and John, 1964; Novick and Roth, 1968; Dyke et al., 1970, Kondo et al., 1974). The metal ion resistance properties of 13136 (cadmium, arsenate, phenylmercury) are extrachromosomal and carried on the same plasmid as the penicillinase enzyme (James and Al-Salihy, 1976). However the metal ion resistance properties of the animal strains were similar irrespective of whether these strains were sensitive or resistant to penicillin.

The pH-mobility curves of methicillin-resistant cells are characteristic in shape and differ from those of -sensitive strains. Furthermore, the shape of the pH-mobility curve of methicillin-resistant strains depends on the growth temperature; these variations can be related to changes in the methicillin resistance properties of the cells (Hill and James, 1972a,b). Low H-values were correlated with methicillin resistance. The H-value (8.5) gives an indication of the amount of phosphate groups located on the cell surface.

In the present work the pH-mobility curves obtained for the methicillin-resistant strain 13136 and the -sensitive strain 9341 grown on agar A1 and A4 confirmed these earlier findings (Figs. 8.1a,b; cf. Fig. 9.2). A significant reduction in the maximum mobility at low pH,

FIGURE 9.2. Typical pH-mobility curves of methicillin-resistant and -sensitive strains of *Staph. aureus* after growth at 25, 37 and 43°C.

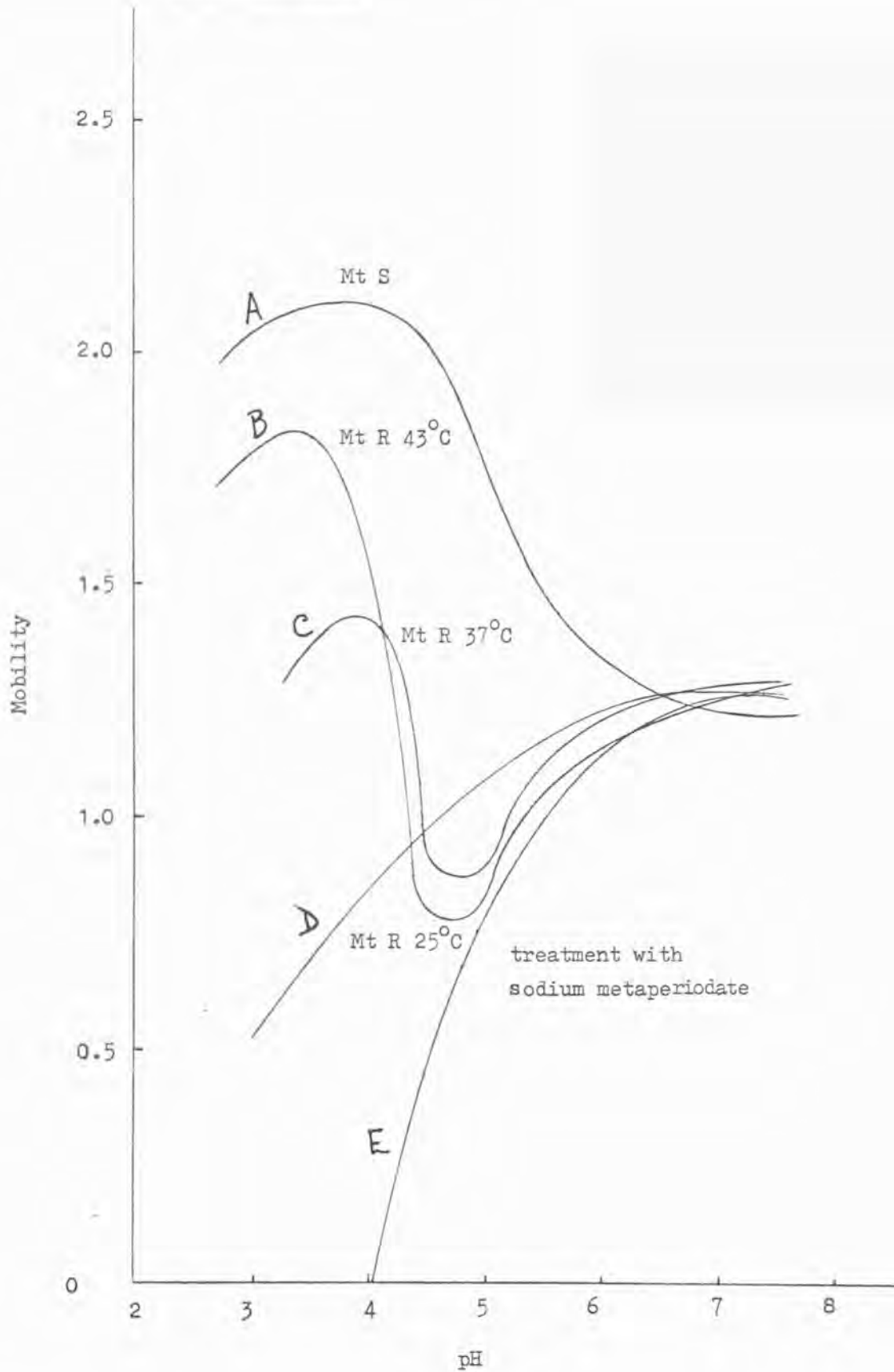

and in the H-value, was obtained for cells of 13136 grown on agar A4 compared with cells grown on agar A1 at 37°C; this did not occur with cells of 9341. This maximum mobility has been attributed to the charged phosphate groups of ribitol teichoic acid at the cell surface (James and Brewer, 1968). Methicillin-resistant cells produce an alkaline phosphatase enzyme system, the metabolic function of which is believed to be the conversion of phosphate ester into inorganic phosphate. This enzyme releases phosphate groups from teichoic acid (with a concomitant decrease in the maximum mobility) when inorganic phosphate, an essential nutrient, is in restricted supply in the growth medium (Davies, 1974). When 13136 is grown on A1 medium containing excess inorganic phosphate the phosphatase enzyme is inhibited; this is shown by a greater maximum mobility indicative of greater amounts of phosphate at the cell surface. Methicillin-sensitive strain 9341 has no detectable phosphatase activity (Davies and James, 1974) nor do changes in the growth media alter the maximum mobility. Thus changes in the inorganic phosphate content of the growth media affected the maximum of the pH-mobility curve and presumably the production of the phosphatase enzyme, but not the methicillin resistance properties of 13136. Davies and James (1974) suggested that the presence or absence of alkaline phosphatase is intimately associated with the presence or absence of surface teichoic acid and with methicillin resistance or sensitivity respectively, although it was not possible to say whether the presence or absence of such an enzyme system conferred resistance or sensitivity to methicillin on the cells. From the present work it seems unlikely that the phosphatase enzyme system and methicillin resistance properties are intrinsically linked.

The pH-mobility curves of the animal strains showed that the cells possessed complex surface properties (Sect. 8.5). The shape and/or

position of these curves varied depending on the strain and/or the growth temperature (Figs. 8.2 - 8.5). The maxima at pH 3.5/4 were attributed to the phosphate groups of teichoic acid, since cells oxidised with sodium metaperiodate exhibited pH-mobility curves characteristic of a single carboxyl-type surface. Teichoic acid is a constituent present on the surface of cells of human origin. The shape of the curves of the bovine and porcine strains could be correlated with those of methicillin-resistant and -sensitive strains of human origin (Fig. 9.2; Table 9.2) but not with resistance or sensitivity to antibiotics, unlike strains of human origin, nor with resistance to metal ions. Poultry strains possessed "not typable" phage-types and surface properties. Porcine strains P3, P4 with similar phage-types exhibited pH-mobility curves which were similar in shape; these shapes could be correlated with those of strains P1 and C3 grown at 37°C, but the phage-types differed.

The H-values of the porcine and poultry strains grown at 37°C were greater, and those of the bovine strains less than the H-values obtained at 43°C. In this respect the bovine strains were more closely related to strains of human origin. The amount of teichoic acid on the cell surface of animal strains and methicillin-resistant strains of human origin is possibly related to the physiological growth temperature (human - 37°C; bovine - 39°C; poultry - 41.5°C; porcine - 40°C) and thus could operate to the physiological advantage of the cell. Low H-values could not be correlated with methicillin resistance, in contrast to methicillin-resistant strains of human origin.

Thus animal strains of Staph. aureus possess phage-types and surface properties which are too complex to warrant any correlation between these properties or with those of the other parameters studied. Neither could any correlation be made with the properties of strains of human origin.

Cells of the methicillin-resistant strain 13136 possessed greater amounts of magnesium but less calcium than did cells of methicillin-sensitive 9341 when grown on A1 media (Table 8.9) (cf. P. aeruginosa where gentamicin-resistant and -sensitive cells grown in B1 media have the same divalent metal ion content, Table 6.3). The magnesium and calcium content of cells of these Staph. aureus strains became similar after growth on agar A4, but the iron content of both strains, and the zinc content of 9341 increased. These changes were not accompanied by changes in antibiotic sensitivity or resistance (in contrast to P. aeruginosa). Thus the increase in the calcium content of methicillin-sensitive and -resistant strains of Staph. aureus grown on agar A4 could not be correlated with changes in antibiotic resistance or cell surface properties, in contrast to gentamicin-resistant and -sensitive cells of P. aeruginosa grown on agar (A3).

Cells of Staph. aureus grown on calcium-rich agar A4 showed increased amounts of calcium and iron, but decreased amounts of magnesium. This suggests that alternative metabolic pathways are available, the pathway utilized depending upon the environment. These divalent metal ions are possibly required to maintain cell rigidity.

Lambert et al., (1975) showed the binding of magnesium ions to wall teichoic acid of Lactobacillus buchneri; one magnesium ion was bound for every two phosphate groups of teichoic acid. In the present work a large reduction in the magnesium content of cells of 13136 grown on A4 media (this reduction was much greater than that of 9341) could possibly be correlated with the reduced amount of teichoic acid on the surface of these cells. This suggests that these ions were associated with the phosphate groups of the teichoic acid.

BIBLIOGRAPHY



- Abramson, H.A., (1934), "Electrokinetic Phenomena", The Chemical Catalog.Co.N.Y.
- Al-Salihi, S.M.S., (1975), Ph.D. Thesis, London.
- Al-Salihi, S.M.S. and James, A.M., (1972), *Lancet*, ii, 331.
- Annear, D.I., (1968), *Med. J. Aust.*, 1, 444.
- Archibald, A.R., and Coapes, H.E., (1971), *Biochem. J.*, 123, 665.
- Asbell, M.A. and Eagon, R.G., (1966a), *Biochem. biophys. res. comm.*, 22, 664.
- Asbell, M.A. and Eagon, R.G., (1966b), *J. Bact.*, 92, 380.
- Asheshov, E.H., (1966), *Nature, Lond.*, 210, 804.
- Baddiley, J., Buchanan, J.G., Rajbhandary, U.L. and Sanderson, A.R., (1962), *Biochem. J.*, 82, 439.
- Barber, M., (1962), "Resistance of Bacteria to the Penicillins", CIBA Foundation Study Group, (J. and A. Churchill, London) p.89.
- Barber, M. and Waterworth, P.M. (1966), *Brit. Med. J.*, i, 203.
- Bartell, P.F., Orr, T.E. and Chudio, B., (1970), *Infection and Immunity*, 2, 543.
- Bayer, M.E. and Remsen, C.C., (1970), *J. Bact.*, 101, 304.
- Bell, R.M., Mavis, R.D., Osborn, M.J. and Vagelos, P.R., (1971), *Biochim. biophys. Acta*, 249, 628.
- Benveniste, R. and Davies, J., (1971a), *Biochem.*, 10, 1787.
- Benveniste, R. and Davies, J., (1971b), *FEBS Letters*, 14, 293.
- Benveniste, R. and Davies, J., (1973), *Proc. Nat. Acad. Sci.*, 70, 2276.
- Bergey's Manual of Determinative Bacteriology, Eighth Edition, (1974), (Ed. by Buchanan, R.E. and Gibbons, N.E., The Williams and Wilkins Co. Baltimore).
- Blair, J.E. and Williams, R.E.O., (1961), *But. Wld. Hlth. Org.*, 24, 771.
- Bobo, R.A. and Eagon, R.G., (1968), *Can. J. Microbiol.*, 14, 503.
- Bradley, T.J., Holdom, R.S. and Khan, N.H., (1975), *Microbios*, 14, 121.
- Braun, V. and Bosch, V., (1972), *Eur. J. Biochem.*, 28, 51.
- Braun, V. and Rehn, K., (1969), *Eur. J. Biochem.*, 10, 426.
- Braun, V. and Sieglin, U., (1970), *Eur. J. Biochem.*, 13, 336.
- Braun, V. and Wolff, H., (1970), *Eur. J. Biochem.*, 14, 387.

- Braun, V., Rehn, K. and Wolff, H., (1970), *Biochem.*, 9, 5041.
- Brewer, J.E., (1966), Ph.D. Thesis, London.
- Brown, M.R.W., (1971), "Inhibition and Destruction of the Microbial Cell", (Ed. W.B. Hugo, Academic Press, London), p. 307.
- Brown, M.R.W., (1975), "Resistance of *Pseudomonas aeruginosa*", (Ed. M.R.W. Brown, J. Wiley and Sons), p. 85.
- Brown, M.R.W. and Foster, J.H., (1971), *J. Pharm. Pharmacol.*, 23, Suppl., 236S.
- Brown, M.R.W. and Melling, J., (1969a), *J. gen. Microbiol.*, 54, 439.
- Brown, M.R.W. and Melling, J., (1969b), *J. gen. Microbiol.*, 59, 263.
- Brown, M.R.W. and Winsley, B.E., (1969), *J. gen. Microbiol.*, 56, 99.
- Brown, M.R.W., Clamp, J.R. and Foster, J.H.S., (1966), *J. gen. Microbiol.*, 45, (V).
- Brown, A.D., Drummond, D.G. and North, R.J., (1962), *Biochim. biophys. Acta*, 58, 514.
- Brown, M.R.W., Foster, J.H.S. and Clamp, J.R., (1969), *Biochem. J.*, 112, 521.
- Bryan, L.E., Semaka, S.D., Van Den Elzen, H.M., Kinnear, J.E., Whitehouse, R.L.S., (1973), *Antimicrobial Agents and Chemotherapy*, 3, 625.
- Bryan, L.E., Shahrabadi, M.S. and Van Den Elzen, H.M., (1974), *Antimicrobial Agents and Chemotherapy*, 6, 191.
- Bryan, L.E. and Van Den Elzen, H.M., (1975), *J. of Antibiotics*, 28, 696.
- Bryan, L.E. and Van Den Elzen, H.M., (1976), *Antimicrobial Agents and Chemotherapy*, 2, 928.
- Bryan, L.E., Haraphongse, R. and Van Den Elzen, H.M., (1976), *J. of Antibiotics*, 29, 743.
- Brzezinska, M., Benveniste, R., Davies, J., Daniels, P.J.L. and Weinstein, J., (1972), *Biochem.*, 11, 761.
- Burge, R.E. and Draper, J.C., (1967), *J. Mol. Biol.*, 28, 205.
- Burman, L.G., Nordström, K. and Bloom, G.D., (1972), *J. Bact.*, 112, 1364.
- Carson, K.J. and Eagon, R.E., (1966), *Can. J. Microbiol.*, 12, 105.
- Chapman, D.B., (1976), Ph.D. Thesis, London.
- Chapman, D.L., (1913), *Phil. Mag.*, 25, 475.
- Chattoraj, D.K. and Bull, H.B., (1959), *J. Phys. Chem.*, 63, 1809.

- Cheng, K.J., Ingram, J.M. and Costerton, J.W., (1971), *J. Bact.*, 107, 325.
- Chester, I.R., Gray, G.W. and Wilkinson, S.G., (1972), *Biochem. J.*, 126, 395.
- Chester, I.R., Meadow, P.M., Pitt, T.L., (1973), *J. gen. Microbiol.*, 78, 305.
- Clarke, P.H. and Lilly, M.D., (1962), *Nature, Lond.*, 195, 516.
- Clarke, K., Gray, G.W. and Reaveley, D.A., (1965), *Nature*, 208, 586.
- Clarke, K., Gray, G.W. and Reaveley, D.A., (1967a), *Biochem. J.*, 105, 749.
- Clarke, K., Gray, G.W. and Reaveley, D.A., (1967b), *Biochem. J.*, 105, 755.
- Clarke, K., Gray, G.W. and Reaveley, D.A., (1967c), *Biochem. J.*, 105, 759.
- Cohen, G.N. and Adelberg, E.A., (1958), *J. Bact.*, 76, 326.
- Colobert, L., (1958), *Ann. Inst. Pasteur*, 95, 156.
- Cooper, D.J. and Marigliano, H.M., (1970), *J. infectious Dis.*, 119, 342.
- Cooper, D.J. and Yudis, M.D., (1967), *Chem. Commun. (London)*, 16, 821.
- Costerton, J.W., Ingram, J.M. and Cheng, K.J., (1974), *Bact. Rev.*, 38, 87.
- Cox, S.T., Jr. and Eagon, R.G., (1968), *Can. J. Microbiol.*, 14, 913.
- Davies, A.L., (1974), Ph.D. Thesis, London.
- Davies, A.L. and James, A.M., (1974), *Microbios*, 10, 257.
- Davies, J., Benveniste, R., Kvitek, K., Ozanne, B. and Yamada, T., (1969), *J. infectious Dis.*, 119, 351.
- Davies, J., Brzezinska, M. and Benveniste, R., (1971), *Trans. N.Y. Acad. Sci.*, 182, 226.
- Davies, J., Gilbert, W. and Gorini, L., (1964), *Proc. Nat. Acad. Sci. U.S.A.*, 51, 883.
- Davies, J.E. and Rownd, R., (1972), *Science*, 176, 758.
- DePamphilis, M.C. and Adler, J., (1971), *J. Bact.*, 105, 396.
- De Petris, S., (1967), *J. Ultrastructure Res.*, 19, 45.
- DeVoe, I.W., Costerton, J.W. and MacLeod, R.A., (1971), *J. Bact.*, 106, 659.
- Doggett, R.G., Harrison, G.M. and Wallis, E.S., (1964), *J. Bact.*, 87, 427.
- Doi, O., Ogura, M., Tanaka, N. and Umezawa, H., (1968), *Appl. Microbiol.*, 16, 1276.
- Domagk, G., (1935), *Dtsch. med. Wschr.*, 61, 250.

- Dvorak, H.F., Wetzel, B.K. and Heppel, L.A., (1970), *J. Bact.*, 104, 542.
- Dyar, M.T., (1948), *J. Bact.*, 56, 821.
- Dyke, K.G.H., Jevons, P. and Parker, M.T., (1966), *Lancet*, i, 835.
- Dyke, K.G.H., Parker, M.T. and Richmond, M.H., (1970), *J. Med. Microbiol.*, 3, 125.
- Eagon, R.G., (1962), *Can. J. Microbiol.*, 8, 585.
- Eagon, R.G., (1969), *Can. J. Microbiol.*, 15, 235.
- Eagon, R.G. and Carson, K.J., (1965), *Can. J. Microbiol.*, 11, 193.
- Eagon, R.G., Simmons, G.P. and Carson, K.J., (1965), *Can. J. Microbiol.*, 11, 1041.
- Ehrlich, P., (1913), *Proc. 17th Intern. Congr. Med.*
- Ellis, R., (1911), *Z. Phys. Chem.*, 78, 321.
- Ellwood, D.C. and Tempest, D.W., (1972), *Advances in Microbiol. Physiol.*, 7, 83. (Eds. A.H. Rose and D.W. Tempest, Academic Press, London).
- Fensom, A.H. and Gray, G.W., (1969), *Biochem. J.*, 114, 185.
- Finland, M. and Hewitt, W.L., (1971), 2nd International Symposium on Gentamicin, *J. infectious Dis.*, 124, Suppl, S1-S300.
- Fleming, A., (1929), *Brit. J. exp. Path.*, 10, 226.
- Florey, H.W., Jennings, M.A., Orr-Ewing, J., Gardener, A.D., Heatley, N.D. and Sanders, A.G., (1940), *Lancet*, ii, 226.
- Forge, A. and Costerton, J.W., (1973), *Can. J. Microbiol.*, 19, 1056.
- Forge, A., Costerton, J.W. and Kerr, K.A., (1973a), *J. Bact.*, 113, 445.
- Forge, A., Costerton, J.W. and Kerr, K.A., (1973b), *Can. J. Microbiol.*, 19, 451.
- Fosberg, C.W., Costerton, J.W. and MacLeod, R.A. (1970a), *J. Bact.*, 104, 1338.
- Fosberg, C.W., Costerton, J.W. and MacLeod, R.A., (1970b), *J. Bact.*, 104, 1354.
- Fox, C.F., (1972), *Sci. Amer.*, 226 (2), 30.
- Frausto da Silva, J.J.R. and Williams, R.J.P., (1976), *Structure and Bonding*, 29, 67.
- Galanos, C., Rietschel, E. Th., Lüderitz, O., Westphal, O., Kim, Y.B. and Watson, D.W., (1972), *Eur. J. Biochem.*, 31, 230.
- Gale, E.F., Cundliffe, E., Reynolds, P.E., Richmond, M.H. and Waring, M.J., (1972), "The Molecular Basis of Antibiotic Action" (John Wiley and Sons, London), p 304.

- Garrett, A.J., (1965), *Biochem. J.*, 95, 6c.
- Garrod, L.P. and Waterworth, P.M., (1969), *J. Clin. Pathol.*, 22, 534.
- Ghuysen, J.M., (1968), *Bact. Rev.*, 32, 425.
- Ghuysen, J.M., Tipper, D.J. and Strominger, J.L., (1965), *Biochem., N.Y.*, 4, 474.
- Gilbert, D.N., Kutscher, E., Ireland, P., Barnett, J.A. and Sanford, J.P., (1971), *J. infectious Dis.*, 124, S37.
- Gilleland, H.E., Stinnett, J.D. and Eagon, R.G., (1974), *J. Bact.*, 117, 302.
- Gilleland, H.E., Stinnett, J.D., Roth, I.L. and Eagon, R.G., (1973), *J. Bact.*, 113, 417.
- Gittens, G.J., (1962), Ph.D. Thesis, London.
- Gittens, G.J. and James, A.M., (1960), *Analyt. Biochem.*, 1, 478.
- Glauert, A.M. and Thornley, M.J., (1969), *Ann. Rev. Microbiol.*, 23, 159.
- Gorini, L. and Kataja, E., (1965), *Biochem. biophys. res. comm.*, 18, 656.
- Gorrill, R.H. and McNeil, E.M., (1960), *J. gen. Microbiol.*, 22, 437.
- Goto, S., Murakawa, T. and Kuwahara, S., (1973), *Japanese J. Microbiol.*, 17, 45.
- Gould, J.C., (1960), *Brit. Med. Bull.*, 16, 29.
- Gouy, G., (1910), *J. Phys. Radium*, 2, 457.
- Gray, G.W. and Wilkinson, S.G., (1965a), *J. Appl. Bacteriol.*, 28, 153.
- Gray, G.W. and Wilkinson, S.G., (1965b), *J. gen. Microbiol.*, 39, 385.
- Grubb, W.B. and O'Reilly, O.J., (1971), *Biochem. biophys. res. comm.*, 42, 377.
- Hahn, F.E. and Sarre, S.G., (1969), *J. infectious Dis.*, 119, 364.
- Hamilton, W.A., (1970), *FEBS Symposium*, 20, 71.
- Hancock, R., (1960), *Biochim. biophys. Acta*, 37, 42.
- Haque, H. and Russell, A.D., (1974), *Antimicrobial Agents and Chemotherapy*, 5, 447.
- Haydon, D.A., (1960), *Proc. Roy. Soc. (London)*, A258, 319.
- Helmholtz, H., (1879), *Ann. Phys.*, 7, 237.
- Heptinstall, S., Archibald, A.B. and Baddiley, J., (1970), *Nature, Lond.*, 225, 519.

- Hewitt, J.H., Coe, A.W. and Parker, M.T., (1969), *J. Med. Microbiol.*, 2, 443.
- Hill, A.W., (1971), Ph.D. Thesis, London.
- Hill, A.W. and James, A.M., (1972a), *Microbios*, 6, 157.
- Hill, A.W. and James, A.M., (1972b), *Microbios*, 6, 169.
- Hill, M.J., James, A.M. and Maxted, W.R., (1963), *Biochim. biophys. Acta*, 75, 414.
- Hochstadt-Ozer, J., (1972), *J. Biol. Chem.*, 247, 2419.
- Holme, T., (1972). *J. Appl. Chem. Biotechnol.*, 22, 391.
- Hotchkiss, R.D. and Evans, A.H., (1960), *Fed. Proc.*, 19, 912.
- Hugo, W.B. and Stretton, R.J., (1966), *J. gen. Microbiol.*, 42, 133.
- Humphrey, B. and Vincent, J.M., (1962), *J. gen. Microbiol.*, 29, 557.
- Ikeda, K. and Egami, P., (1973), *J. Gen. Appl. Microbiol.*, 19, 115.
- Ivanov, Von. W., Markov, K.I., Golowinsky, E. and Charisanova, T., (1964), *Z. Naturforschg*, 19b, 604.
- Jacoby, G.A., (1974), *Antimicrobial Agents and Chemotherapy*, 6, 239.
- James, A.M., (1979a), *Surface and Colloid Sci.*, 11, 121.
- James, A.M., (1979b), "Molecular Aspects of Biological Surfaces", *Chemical Society Reviews*, (The Chemical Society, London), 8(3), 389.
- James, A.M. and Al-Salihi, S.M.S., (1976), *Microbios Letters*, 1, 177.
- James, A.M. and Brewer, J.E., (1968), *Biochem. J.*, 107, 817.
- James, A.M. and Prichard, F.E., (1974), "Practical Physical Chemistry", (3rd Ed., Longman Group Ltd), p45.
- Jao, R.L. and Jackson, G.G., (1963), *Antimicrobial Agents and Chemotherapy*, (American Soc. for Microbiology, Washington), p148.
- Johnston, L.H. and Dyke, K.G.H., (1971), *J. Bact.*, 107, 68.
- Kabins, S., Nathan, C. and Cohen, S., (1974), *Antimicrobial Agents and Chemotherapy*, 5, 565.
- Keleman, M.V. and Rogers, H.J., (1971), *Proc. Nat. Acad. Sci. U.S.A.*, 68, 992.
- Kellenberger, E. and Ryter, A., (1958), *J. Biophys. Biochem. Cytol.*, 4, 323.
- Kobayashi, F., Yamaguchi, M. and Mitsuhashi, S., (1971a), *Japanese J. Microbiol.*, 15, 265.
- Kobayashi, F., Yamaguchi, M. and Mitsuhashi, S., (1971b), *Japanese J. Microbiol.*, 15, 381.

- Kobayashi, F., Yamaguchi, M. and Mitsuhashi, S., (1972), *Antimicrobial Agents and Chemotherapy*, 1, 17.
- Komagata, S.I., (1933), *Res. Electroteck. Lab. Tokyo*, No. 348.
- Kondo, I., Ishikawa, T. and Nakahara, H., (1974), *J. Bact.*, 117, 1.
- Kondo, I., Nakahara, H. and Ishikawa, T., (1975), *Microbiol Drug Res.*, (Univ. of Tokyo Press, Tokyo) p145.
- Kono, M. and O'Hara, K., (1975), *J. gen. Microbiol.*, 91, 191.
- Korfhagen, T.R. and Loper, J.C., (1975), *Antimicrobial Agents and Chemotherapy*, 7, 69.
- Korfhagen, T.R., Loper, J.C. and Ferrel, J.A., (1975), *Antimicrobial Agents and Chemotherapy*, 7, 64.
- Lambert, P.A., Hancock, I.C. and Baddiley, J., (1975), *Biochem. J.*, 149, 519.
- Leive, L., (1968), *J. Biol. Chem.*, 243, 2372.
- Lickfield, K.G., Achterrath, M., Hentrich, F., Kolehmainen-Sevens, L. and Persson, A., (1972), *J. Ultrastruct. Res.*, 38, 27.
- Lindberg, A.A. and Hellerquist, C.G., (1971), *J. Bact.*, 105, 57.
- Lindsay, S.S., Wheeler, B., Sanderson, K.E., Costerton, J.W. and Cheng, K.J., (1973), *Can. J. Microbiol.*, 19, 335.
- Losnegard, N. and Oeding, P., (1963), *Acta. Path. Microb. Scand.*, 58, 493.
- Loutit, J.S., (1970), *Genet. Res. (Camb.)*, 16, 179.
- Lowick, J.H.B. and James, A.M., (1957), *Biochem. J.*, 65, 431.
- Lowy, J. and Hanson, J., (1965), *J. Mol. Biol.*, 11, 293.
- Lüderitz, O., Westphal, O., Staub, A.M. and Nikaido, H., (1971), "Microbial Endotoxins", (Ed. G. Weinbaum, S. Kadis and S.J. Ajl., Academic Press, N.Y.) Chap. 4.
- Mandelstam, J., (1962), *Biochem. J.*, 84, 294.
- Mandelstam, J. and Rogers, H.J., (1959), *Biochem. J.*, 72, 654.
- Mandelstam, J. and Strominger, J.L., (1961), *Biochem. biophys. res. comm.*, 5, 466.
- Marshall, N.J., (1969), Ph.D. Thesis, London.
- Martin, E.L. and MacLeod, R.A., (1971), *J. Bact.*, 105, 1160.
- Martin, H.H., Heilmann, H.D. and Preusser, H.J., (1972), *Archiv für Mikrobiologie*, 83, 332.
- McDonald, I.J. and Adams, G.A., (1971), *J. gen. Microbiol.*, 65, 201.

- Meadow, P., (1975), "Genetics and Biochemistry of *Pseudomonas*"  
(Ed. Clarke, P.H. and Richmond, M.H., John Wiley and Sons, London), p67.
- Melling, J. and Brown, M.R.W., (1975), "Resistance of *Pseudomonas aeruginosa*"  
(Ed. M.R.W. Brown, John Wiley and Sons), p35.
- Michaelis, L., (1931), *Biochem. Z.*, 234, 139.
- Mitsuhashi, S., Kobayashi, F. and Yamaguchi, M., (1971), *J. Antibiot.*, 24, 400.
- Moore, B., (1960), *Lancet*, *ii*, 453.
- Moyer, L.S., (1936), *J. Bact.*, 31, 531.
- Munch-Petersen, E. and Boundy, C., (1962), *But. Wld. Hlth. Org.*, 26, 241.
- Murray, R.G.E., (1962), *Soc. Gen. Microbiol.*, Symposium No. 12, p119.
- Murray, R.G.E. and Birch-Andersen, A., (1963), *Can. J. Microbiol.*, 9, 393.
- Nakahara H., Ishikawa, T., Sarai, Y., Kondo, I., Kozukue, H. and Silver, S.,  
(1977), *Applied and Environmental Microbiology*, 33, 975.
- Nakane, P.K., Nichoalds, G.E. and Oxender, D.L., (1968), *Science*, 161, 182.
- Noller, E.C. and Hartsell, S.E., (1961a), *J. Bact.*, 81, 482.
- Noller, E.C. and Hartsell, S.E., (1961b), *J. Bact.*, 81, 492.
- Nomura, M., (1970), *Bact. Rev.*, 34, 228.
- Novick, R.P., (1963), *J. gen. Microbiol.*, 33, 121.
- Novick, R.P. and Roth, C., (1968), *J. Bact.*, 95, 1335.
- Okamoto, S. and Suzuki, Y., (1965), *Nature, Lond.*, 208, 1301.
- O'Leary, G.P., Nelson, J.D. Jr. and MacLeod, R.A., (1972), *Can. J. Microbiol.*, 18, 601.
- Ortiz, P., (1970), *Biochemistry*, 9, 355.
- Osborn, M.J., (1971), "Structure and Function of Biological Membranes",  
(Academic Press Inc., N.Y.), p343.
- Osborn, M.J., Gander, J.E., Parisi, E. and Carson, J., (1972), *J. Biol. Chem.*,  
247, 3962.
- Palumbo, S.A., (1972), *J. Bact.*, III, 430.
- Park, J.T., (1952), *J. Biol. Chem.*, 194, 877.
- Park, J.T. and Strominger, J.L., (1957), *Science, N.Y.*, 125, 99.
- Parker, M.J. and Hewitt, J.H., (1970), *Lancet*, *i*, 800.



- Pechey, D.T., (1973), Ph.D. Thesis, London.
- Pechey, D.T. and James, A.M., (1974), *Microbios*, 10A, 111.
- Pechey, D.T., Yau, A.O.P. and James, A.M., (1974), *Microbios*, 11, 77.
- Percival, A., Brumfitt, W. and de Louvois, J., (1963), *J. gen. Microbiol.*, 32, 77.
- Perret, C.J., (1954), *Nature*, 174, 1012.
- Petit, J.F., Muñoz, E. and Ghuyssen, J.M., (1966), *Biochemistry*, N.Y., 5, 2765.
- Pickett, A.W and Dean, A.C.R., (1976), *Microbios*, 15, 79.
- Plummer, D.T., James, A.M., Gooder, H. and Maxted, W.R., (1962), *Biochim. biophys. Acta*, 60, 595.
- Poston, S.M., (1966), *Nature*, London, 210, 802.
- Powney, J. and Wood, L.J., (1940), *Trans. Faraday Soc.*, 36, 57.
- Price, K.E., Zolli, Z., Atkinson, J.C., Luther, H.G., (1957a), *Antibiotics and Chemotherapy*, 7, 672.
- Price, K.E., Zolli, Z., Atkinson, J.C., Luther, H.G., (1957b), *Antibiotics and Chemotherapy*, 7, 689.
- Ramirez-Ronda, C.H., Holmes, R.K. and Sanford, J.P., (1975), *Antimicrobial Agents and Chemotherapy*, 7, 239.
- Repaske, R., (1956), *Biochim. biophys. Acta*, 22, 189.
- Repaske, R., (1958), *Biochim. biophys. Acta*, 30, 225.
- Richmond, M.H., (1965), *Biochem. J.*, 94, 584.
- Richmond, M.H. and John, M., (1964), *Nature*, Lond., 202, 1360.
- Richmond, M.H., Parker, M.T., Jevons, M.P. and John, M., (1964), *Lancet*, i, 293.
- Roberts, N.A., Gray, G.W. and Wilkinson, S.G., (1970), *Microbios*, 2, 189.
- Robinson, A. and Tempest, D.W., (1973), *J. gen. Microbiol.*, 78, 361.
- Roe, E.A. and Jones, R.J., (1974), *Brit. J. Exp. Pathol.*, 55, 336.
- Roe, E.A., Jones, R.J. and Lowbury, E.J.L., (1971), *Lancet*, i, 149.
- Rogers, H.J., (1970), *Bact. Rev.*, 34, 194.
- Rogers, H.J. and Perkins, H.R., (1959), *Nature*, Lond., 184, 520.
- Rogers, S.W., Gilleland, H.E. and Eagon, R.G., (1969), *Can. J. Microbiol.*, 15, 743.
- Rolinson, G.N., Batchelor, F.R., Stevens, S., Cameron-Wood, J. and Chain, E.O., (1960), *Lancet*, ii, 564.

- Rosenblatt, J.E., Barrett, J.E., Brodie, J.L., Kirby, M.M., (1966),  
Antimicrobiol Agents and Chemotherapy, Ann Abor, American Society  
Microbiol., p134.
- Rothfield, L. and Romeo, D., (1971), "Structure and Function of Biological  
Membranes", (Academic Press Inc., N.Y.), p251.
- Rothfield, L., Takeshita, M., Pearlman, M. and Horne, R.W., (1966),  
Proc. Fed. Amer. Soc. Exp. Biol., 25, 1495.
- Sabath, L.D., Jago, M. and Abraham, E.P., (1965), Biochem. J., 96, 739.
- Sabath, L.D., Leaf, C.D., Gerstein, D.A. and Finland, M., (1970),  
Nature, 225, 1074.
- Sabet, S.F. and Schnaitman, C.A., (1973), J. Biol. Chem., 248, 1797.
- Sagai, H., Krcmery, V., Hasuda, K., Iyobe, S., Knothe, H., Mitsuhashi, S.,  
(1975), Japanese J. Microbiol., 19, 427.
- Salton, M.R.J., (1952), Biochim. biophys. Acta, 2, 334.
- Salton, M.R.J., (1953), Biochim. biophys. Acta, 10, 512.
- Salton, M.R.J., (1956), Symp. Soc. Gen. Microbiol., 6, 81.
- Salton, M.R.J., (1958), J. gen. Microbiol., 18, 481.
- Schnaitman, C.A., (1970a), J. Bact., 104, 882.
- Schnaitman, C.A., (1970b), J. Bact., 104, 890.
- Schnaitman, C.A., (1971), J. Bact., 108, 553.
- Schwarzmann, S. and Boring, J.R., (1971), Infection and Immunity, 3, 762.
- Scudi, J.V., and Woodruff, H.B., (1949), "The Chemistry of the Penicillins",  
(Princeton Univ. Press), p1026.
- Seaman, G.V.F., (1965), "Cell Electrophoresis", (Ed. Ambrose, Churchill,  
London), p4.
- Seligman, S.J., (1966), Nature, 209, 994.
- Shafa, F. and Salton, M.R.J., (1960), J. gen. Microbiol., 23, 137.
- Shah, D.B. and Blobel, H., (1967), J. Bact., 94, 780.
- Sillén, L.G. and Martell, A.E., (1964), "Stability Constants of Metal Ion  
Complexes", (The Chemical Society, London), p186.
- Smith, D.H., (1967), Science, 156, 1114.
- Smith, J.T., Hamilton-Miller, J.M.T. and Knox, R., (1969), J. Pharm.  
Pharmacol., 21, 337.

- Smoluchowski, M., (1921), "Handbuch der electricitat und der Magnetismus".  
(Barth), 2, 366.
- Stanier, R.Y., Palleroni, N.J. and Doudroff, M., (1966), *J. gen. Microbiol.*,  
43, 159.
- Stern, O., (1924), *Z. Electrochem.*, 30, 508.
- Stinnett, J.D., Gilleland Jr., H.E., and Eagon, R.G., (1973), *J. Bact.*,  
114, 399.
- Stone, H.H. and Kolb, L.D., (1971), *J. Trauma*, 11, 586.
- Strange, R.E., and Kent, L.H., (1959), *Biochem. J.*, 71, 333.
- Strominger, J.L., Park, J.T. and Thomson, R.E., (1959), *J. Biol. Chem.*,  
234, 3263.
- Summers, A.O. and Lewis, E., (1973), *J. Bact.*, 113, 1070.
- Sutherland, R., (1964), *J. gen. Microbiol.*, 34, 85.
- Sutherland, R., and Rolinson, C.N., (1964), *J. Bact.*, 87, 887.
- Tipper, D.J. and Strominger, J.L., (1965), *Proc. Nat. Acad. Sci. U.S.A.*,  
54, 1133.
- Tourtellotte, M.E. and Zupnik, J.S., (1973), *Science*, 179, 84.
- Van Rensburg, A.J. and De Kock, M.J., (1974), *J. gen. Microbiol.*, 82, 207.
- Voegtlin, C. and Smith, H.W.L., (1920), *J. pharmacol. exptl. Therap.*, 15, 475.
- Wagman, G.H., Marquez, J.A., Weinstein, M.J., (1968), *J. Chromatogr.*, 34, 210.
- Wanatabe, T., (1971), *Ann. N.Y. Acad. Sci.*, 182, 126.
- Weidel, W., Franck, H. and Martin, H.H., (1960), *J. gen. Microbiol.*, 22, 158.
- Weinstein, M.J., Leudemann, G.M., Oden, E.M. and Wagman, G.H., (1963),  
*Antimicrobial Agents and Chemotherapy*, (American Soc. for  
Microbiology, Washington), p.1.
- Weiss, R.L. and Fraser, D., (1973), *J. Bact.*, 113, 963.
- Wersall, J., Lundquist, P.G. and Bjorkroth, B., (1969), *J. infectious Dis.*,  
119, 410.
- White, D.A., Albright, F.R., Lennarz, W.L., Schnaitman, C.A., (1971),  
*Biochim. biophys. Acta*, 249, 636.
- White, D.A., Lennarz, W.J. and Schnaitman, C.A., (1972), *J. Bact.*, 109, 686.
- Wilkinson, J.H., (1958), *Bact. Rev.*, 22, 46.

- Wilkinson, S.G., (1967), J. gen. Microbiol., 47, 67.
- Wilkinson, S.G., (1970), J. Bact., 104, 1035.
- Wilkinson, S.G., (1975), "Resistance of Pseudomonas aeruginosa" (Ed. M.R.W. Brown, John Wiley and Sons), Chap. 5, p145.
- Witchitz, J. L. and Chabbert, Y.A., (1971), J. of Antibiotics, 24, 137.
- Work, E., (1957), Nature, Lond., 179, 89.
- Zimelis, V.M. and Jackson, G.G., (1973), J. infectious Dis., 127, 663.