

An Investigation of Metal Accumulation by Plants
with Particular Reference to Zinc

A Thesis submitted to the University of London

by

Martin J. Pitt Grad. R.I.C. M.Sc. D.I.C.

for the degree of

Doctor of Philosophy

Bedford College

Regent's Park

London N.W.1

April 1977

ProQuest Number: 10098326

All rights reserved

INFORMATION TO ALL USERS

The quality of this reproduction is dependent upon the quality of the copy submitted.

In the unlikely event that the author did not send a complete manuscript and there are missing pages, these will be noted. Also, if material had to be removed, a note will indicate the deletion.

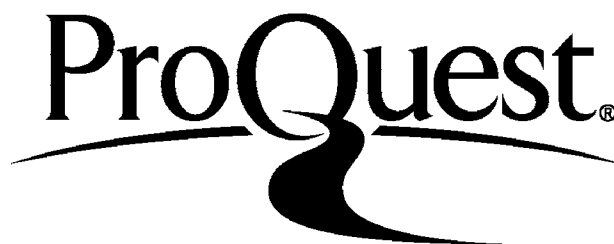

ProQuest 10098326

Published by ProQuest LLC(2016). Copyright of the Dissertation is held by the Author.

All rights reserved.

This work is protected against unauthorized copying under Title 17, United States Code.
Microform Edition © ProQuest LLC.

ProQuest LLC
789 East Eisenhower Parkway
P.O. Box 1346
Ann Arbor, MI 48106-1346

Abstract

Aerial tissues of two highly mineralized plant samples from a zinc site were examined for their treatment of the metal. For one of the species, Crotalaria nova hollandiae, extremely high zinc concentrations were found in its tissues, particularly in the leaves. The majority of the metal was water soluble and present apparently as the Zn^{2+} (aq) ion. Most of the insoluble zinc was bonded to pectin. For the other species, Polycarpaea glabra, the zinc levels were very much lower and less water soluble than in Crotalaria and two soluble zinc complexes were found. One, which was dominant in the stem, was identified as a zinc pectinate, the other, found particularly in flowers, was not characterized. Green stem material of Polycarpaea glabra was found to possess a lower zinc concentration than woody stem but a higher proportion of water insoluble zinc associated with pectin.

Treatment of zinc by the two species was found to be different in other ways. By the use of ultracentrifugation, histochemistry and the electron microprobe Crotalaria nova hollandiae was found to accumulate zinc in the phloem of leaves, Polycarpaea glabra to accumulate particularly in walls of certain cells and probably the phloem. In addition, Polycarpaea glabra accumulated zinc in new leaves and leaf nodes and the majority of the metal was associated with pectin of the the cell walls. Plants from high zinc and low zinc sites treated zinc differently (a higher proportion of zinc in plants from low zinc sites was associated with proteins), but examination of cell wall-metal interaction did not reveal any corresponding differences.

Mechanisms by which the two plants tolerate their high

metal burdens are suggested.

Other mineralized plant species were examined and findings reported here include the accumulation of iron in the leaf xylem walls of Helichrysum leptolepis, the isolation of a water soluble copper-protein complex in the same species and accumulation of lead (from car-exhaust polluted soil) in the primary branches of Ecboium lugardae.

Emphasis is made throughout of the analytical techniques employed and their applicability to plant studies.

Acknowledgements

I should like to thank my supervisor, Dr. M.E. Farago, for her help and encouragement, and also Professor G.H. Williams, the academic and technical staff of the Chemistry Department, Bedford College.

My thanks are also due to Professor Cole and the Geography Department for collecting the plant samples from Africa and Australia and to Miss P. Catt for giving me background information on them.

Brunel University is thanked for the use of microprobe facilities.

CONTENTS

	Page
Forward	7
<u>Chapter I</u> Introduction and background	8
1 Plant cell structure	8
2 Chemical structure of cell wall	10
3 Chemical structure of plasmalemma	14
4 Essentiality of heavy metals	16
5 Copper, iron and zinc metabolism	17
6 Take-up mechanism	20
7 Toxicity	24
8 Tolerance	26
9 Cell wall as accumulation site	33
10 Complexation in plants	37
11 Practical techniques and difficulties	38
<u>Chapter II</u> General analysis of plant material	55
1 Metal concentration determination	55
2 Extractions	61
<u>Chapter III</u> Investigation of soluble metal fractions	72
1 Background	72
2 General methods	76
3 Method for zinc	78
4 Use of electrophoresis	84
5 Investigation of ligands	86
6 Copper and iron in plant extracts	93
7 Copper-amino acid complexes	94
8 Electrophoresis of copper and iron compounds	100

	Page
9 Summary	100
10 Determination of zinc in protein (Levitt method)	101
11 Determination of zinc in protein (Sevag method)	104
12 Discussion	106
<u>Chapter IV</u> Insoluble metal compounds and accumulation sites	109
1 Introduction	109
2 Determination of insoluble zinc compounds	110
3 Accumulation site determination	117
1) Histochemistry	117
2) Ultracentrifugation	131
3) Autoradiography	135
4) Electron microprobe analysis	137
5) Summary	143
<u>Chapter V</u> Further investigation of insoluble zinc compounds	145
1 Introduction	145
2 Cell wall sites	156
3 Zinc absorption capacity of cell walls	161
<u>Chapter VI</u> Summary and suggested future research	164
Appendix	169
References	173

An Investigation of Metal Accumulation by Plants with
Particular Reference to Zinc

Foreword

Many plant species and ecotypes have been found, not only to grow and thrive on sites possessing heavy metals, but to take up high concentrations of these metals into their aerial tissues. This phenomenon has been employed in geobotanical prospecting for ores. However, it raises questions as to how the metals are bonded within the tissues so as to avoid the metabolic disruption normally associated with high metal concentrations. Here an attempt is made to investigate the chemical bonding and physical location of accumulation sites of heavy metals in certain plant species.

Though primarily a chemical investigation, the compounds are present and have been formed in a botanical environment, the reactants arriving at reaction sites via biological pathways and therefore some botanical background must be given. Hence in the introduction a brief description of the structure of a typical plant cell is first presented together with a chemical description of relevant cell structures. A description of the biological roles of zinc, copper and iron and the mechanism of their uptake is followed by a short section on their mode of toxic action.

After this biological background the introduction continues with a survey of metal chemical bonding observed in plants, particularly in tolerance studies and the final part of the introduction comprises a large section on the techniques employed here and the practical difficulties involved.

1. Introduction

1.1 Plant cell structure

Higher plant cells vary enormously in structure according to function, age, species, general condition and other factors. However, the essential features common to most plant cells may be distinguished in a description of a typical young plant cell. In simple terms the cell is

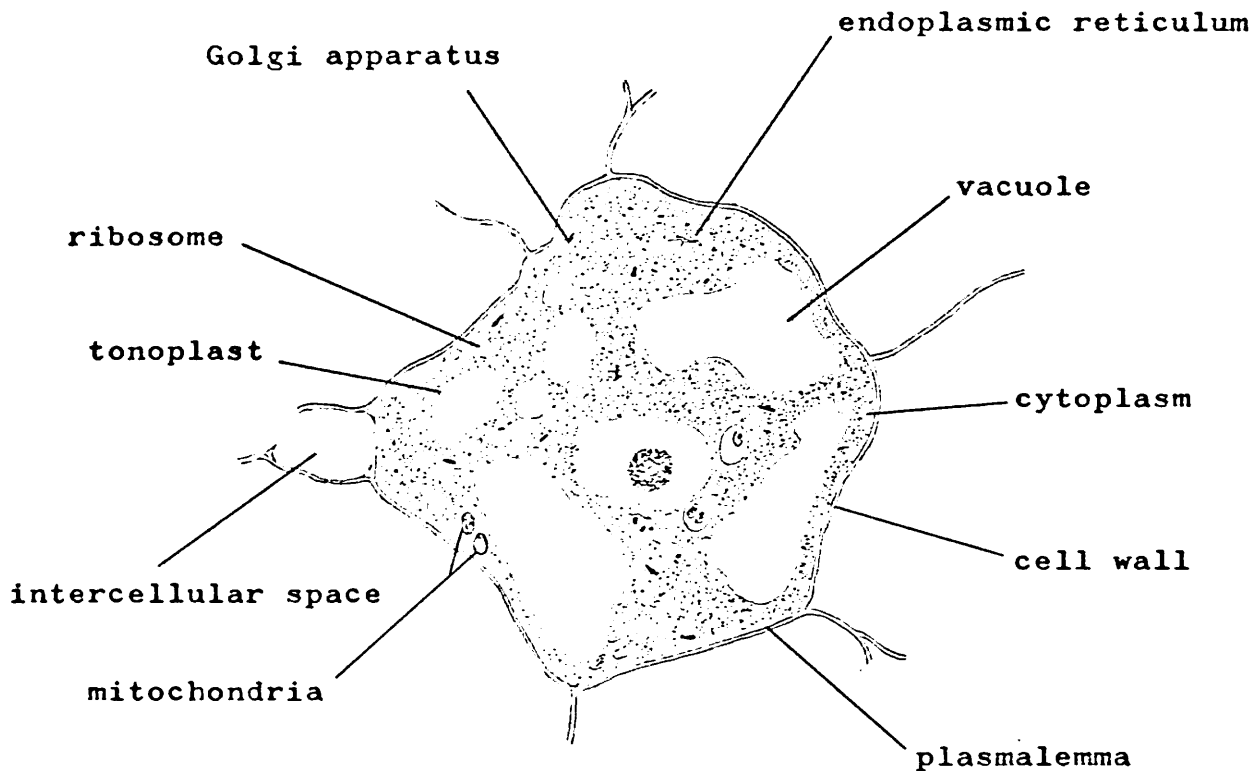

Fig. I Typical young plant cell structure

(After Esau 1965)

bounded by a "cellulose" cell wall, pressed against this by the turgor pressure of the cell solution, is the plasma membrane or plasmalemma. In a young cell the cytoplasm fills most of the available space and the various organelles and vacuoles are suspended within it. As the cell matures the vacuoles grow in size and coalesce until a single vacuole occupies 80% or more of the cell volume. The cytoplasm with its organelles is then restricted to a thin

layer on the inside of the plasmalemma. The vacuoles themselves are bounded by a membrane, the tonoplast, and contain water and high concentrations of inorganic salts, sugars and even pigments.

The other major features shown in the diagram are the nucleus, mitochondria, ribosomes, Golgi apparatus and endoplasmic reticulum. The nucleus is very prominent and is essential to the cell for long-term continuation of metabolism and for the ability of the cell to significantly alter its structure and function during growth (differentiation). Mitochondria are found in varying numbers in virtually all plant cells. They are typically 0.5 - 1.0 μ m in diameter and 5 - 10 μ m in length. Composed of 25 - 30% lipid and 60 - 75% protein, mitochondria play important roles in many metabolic pathways including the breakdown and synthesis of carbohydrates, fats and amino acids.

Ribosomes appear in the electron microscope as ellipsoidal bodies of about 1.5 - 2.5 μ m, consisting of two sub-units of unequal size. They are composed of ribonucleic acid and protein, a very high percentage (typically about 70%) of total RNA in the cell is found in ribosomes. They play an important role in protein synthesis viz. they provide the surface at which coupling of amino acids occurs to form proteins.

The Golgi apparatus appears to consist of many apparently unconnected units called dictyosomes. The total number of units in the cell varies from tens to hundreds and each sub-unit appears to end in a membrane delimited saccule. There are between three and seven saccules per dictyosome (stack). Extensive knowledge of the functions

of the Golgi apparatus has not been derived but it is known to be the site of synthesis and concentration of polysaccharides.

The endoplasmic reticulum is an extensive, membranous system of tubules and sacs within which proteins, lipids and other materials are transported throughout the cell. It also possesses enzyme secretion abilities. 'Rough' endoplasmic reticulum is studded with ribosomes.

Finally, most cells in higher plants are not completely isolated from one another but connected by small channels through adjacent cell walls so that the cytoplasm of one cell and the next is continuous. These cytoplasmic interconnections are called plasmodesmata and provide the means whereby material can pass from cell to cell. Interestingly, endoplasmic reticulum is often found in close proximity to plasmodesmata.

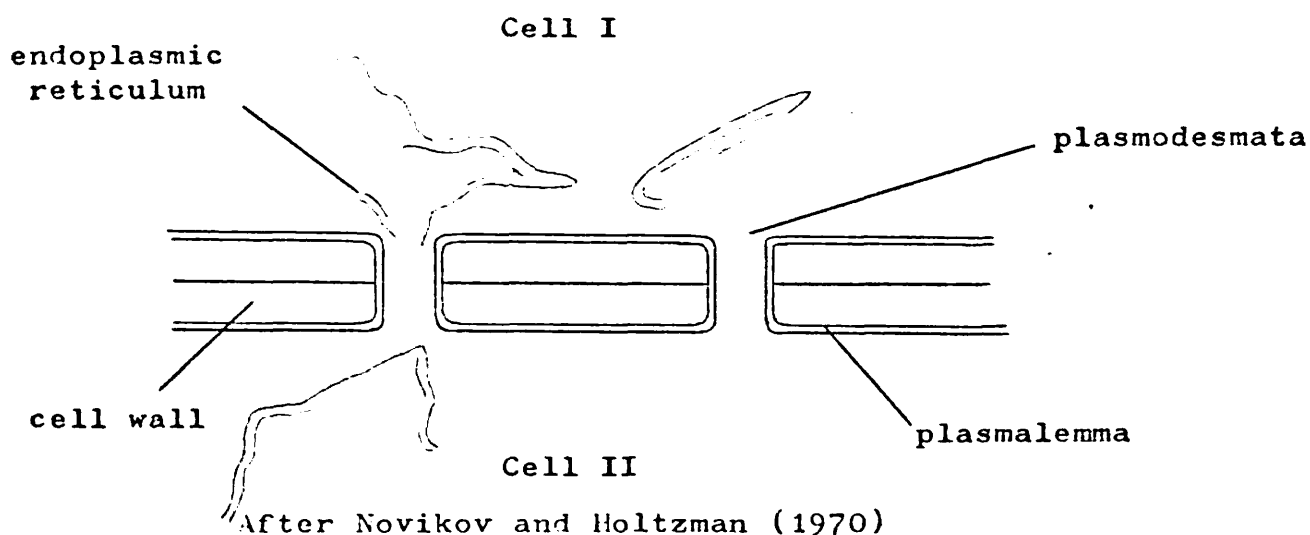

Fig. II Plasmodesmata

1.2 Chemical structure of cell wall material

Cell walls may be considered to be of two types - primary and secondary. Primary walls are thin and are laid

down during the growing period of the cell and these structures are similar in different species (Albersheim 1972). Thicker secondary walls are formed when the cell has stopped growing. These are very different from cell to cell, plant sample to plant sample and species to species.

Primary cell walls consist basically of a dispersed phase of cellulose microfibrils in a complex, continuous matrix. Northcote (1972) likened the structure to man-made reinforced plastic with the intertwined microfibrils representing the glass fibres and a whole variety of substances representing the plastic, fillers, wetting agents, swelling agents and skin.

The microfibrils are approximately 10nm in diameter and consist of long chains of $\beta(1 - 4)$ linked glucose residues comprising 8,000 to 12,000 units. The basic matrix comprises hemicellulose, pectic substances and water. Other substances such as xylans (or galactoglucomannans) and lignin are laid down at the cell wall during the life of the cell.

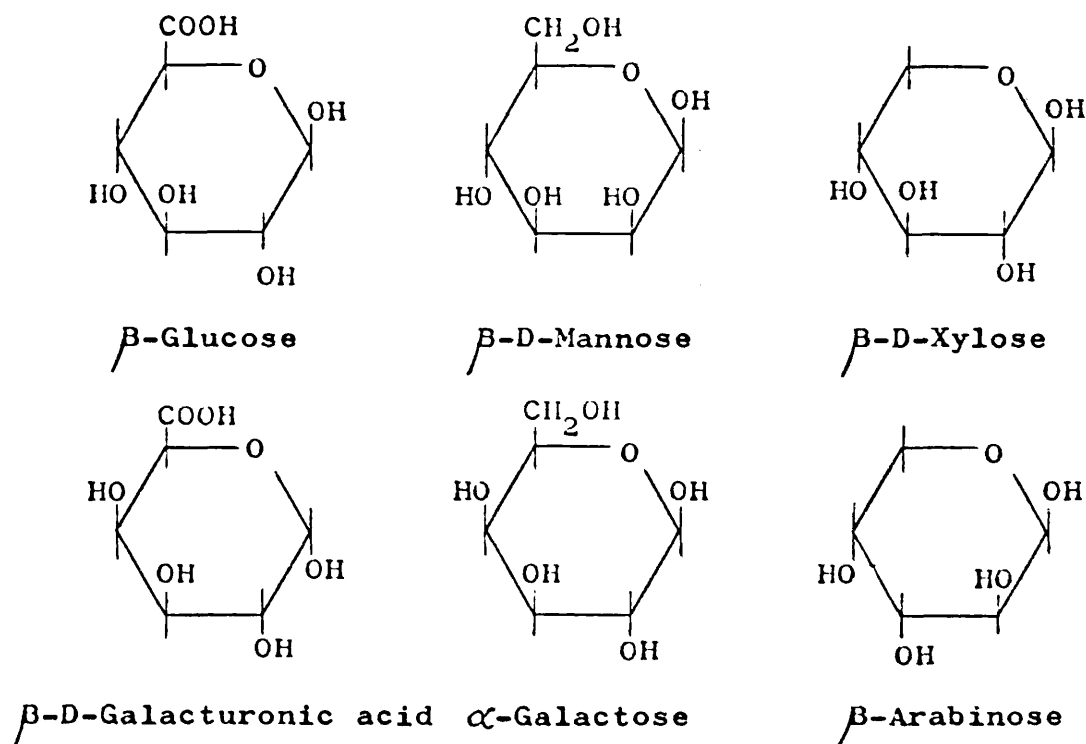

Fig. III Carbohydrate units

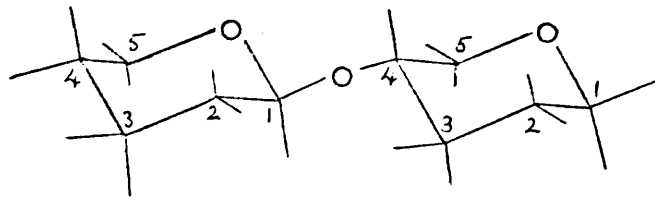

Fig. IV $\beta(1 \rightarrow 4)$ linkage

Hemicellulose, a major constituent of the matrix, consists principally of xylans (polysaccharide structures based on the D-xylopyranose unit joined $\beta(1 \rightarrow 4)$ comprising 150 - 200 units), but mannans, glucomannoglycans, galactans, arabinogalactoglycans, arabinoxyloglycans and pectic substances may also be present. Hemicellulose has no precise structure but is very complex. It is soluble in alkali. Albersheim (1973), however, found the major constituent of hemicellulose in sycamore primary cell walls to be xyloglucan.

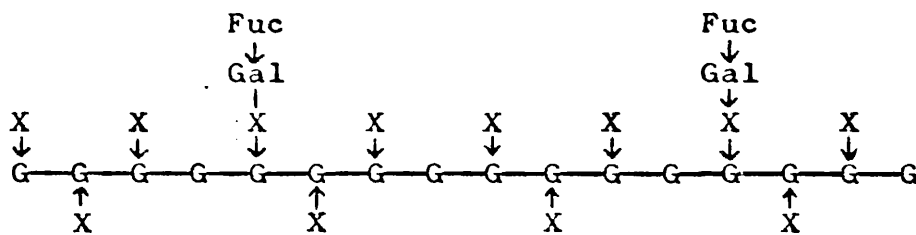

Fig. V Xyloglucan molecule (Albersheim 1972)

X - xylose
 G - glucose
 Gal - galactose
 Fuc - fucose

(linkages are $G-\beta-(1 \rightarrow 4)-G$; $X-\alpha-(1 \rightarrow 6)-G$; $Gal-\beta-(1 \rightarrow 2)-X$ and $Fuc-\alpha-(1 \rightarrow 2)-Gal$).

Pectic substances of the cell wall matrix comprise complex, often colloidal macromolecular polygalacturonic acids which contain a large proportion of anhydrogalacturonic

acid. The carboxylic acid groups may be esterified by methyl groups to some degree or neutralized by bases. Galactose and arabinose are always present in pectic substances (Florkin and Stotz (1963)). Albersheim (1972) found the basic pectic polymer of sycamore to be a ribbon-like polygalacturonic acid chain with an occasional rhamnose radical incorporated.

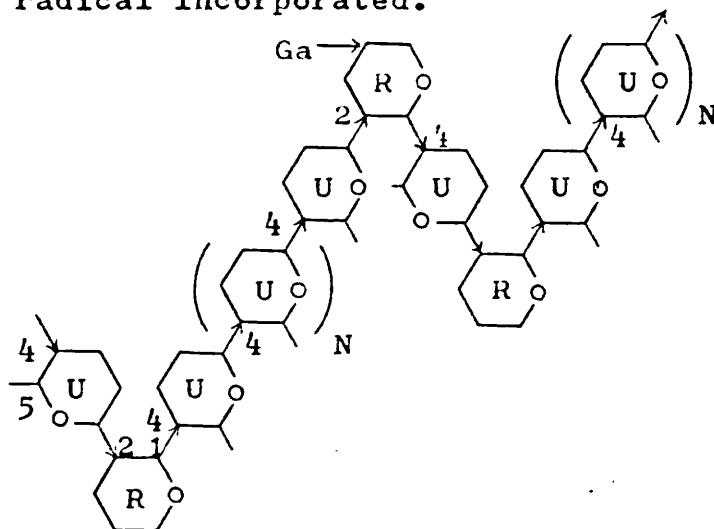
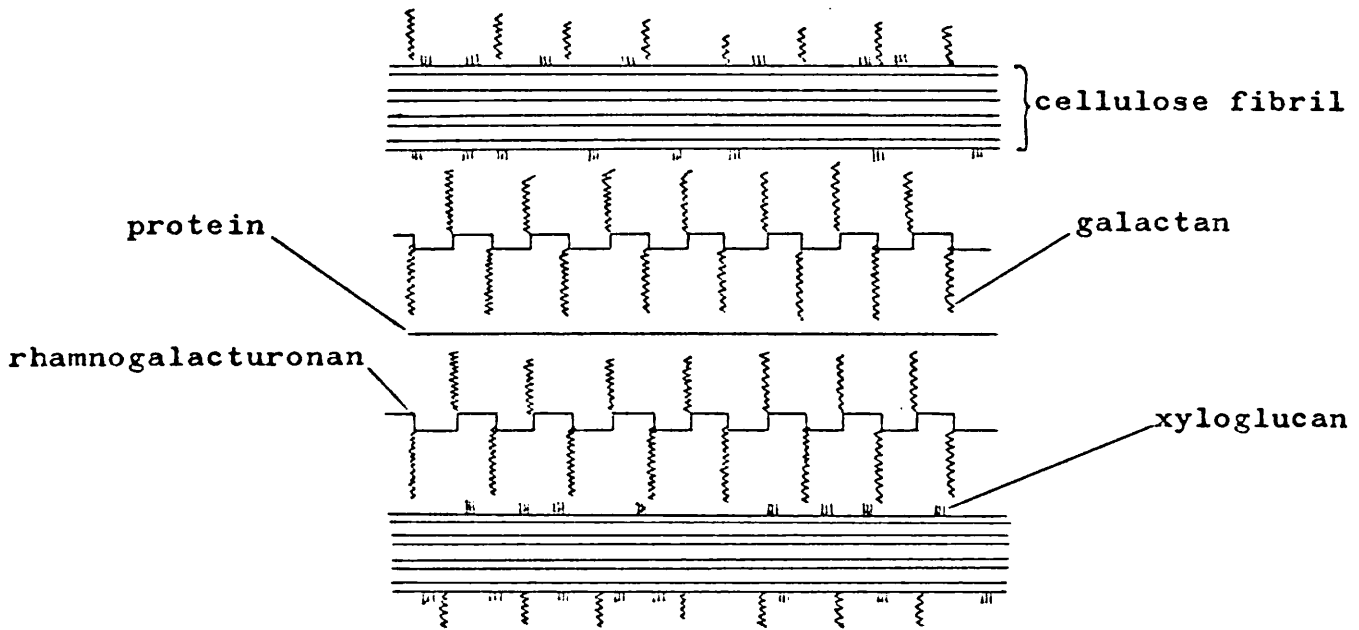

Fig. VI Rhamnagalacturonan, acid pectic polymer

Galactose molecules are present in $\beta(1 - 4)$ chains and around the outside, a branched arabinose shell. This shell is very hydrophilic and holds water in the interconnecting network of the uronic acid polymer in gel formation.

The pectin polysaccharides may be considered as a filler in the matrix altering the water distribution and hence affecting the physical properties of the wall. Increasing the pectin level of a cell wall weakens the hydrogen bonding between the hemicellulose and the microfibrils and results in greater flexibility in the cell wall. This property is required for growing cells and it is found in practice that it is at this period of primary cell growth that pectin is deposited in the wall (Northcote (1972)).



Tentative cell wall structure (Keegstra et. al. (1973))

Fig. VII

1.3 Chemical structure of the plasmalemma

Plasma membranes consist of approximately 20% lipid and 80% protein by weight. The lipids present are highly polar and mainly phospholipids, e.g. lecithin.

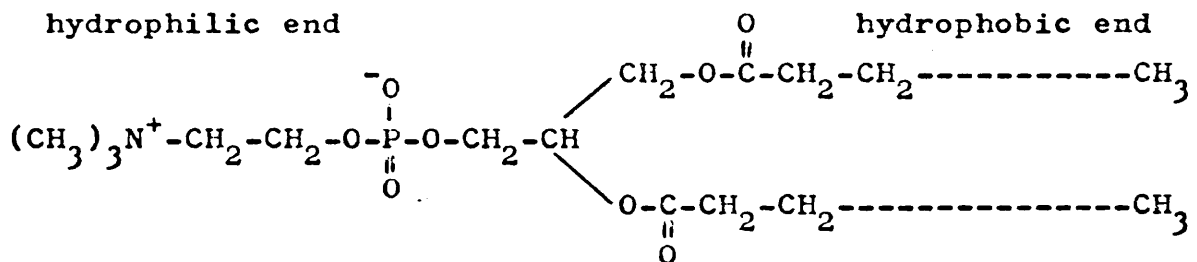

Fig. VIII Phospholipid (lecithin)

The actual arrangement of the constituents in the membrane is a matter of controversy but it is widely held to consist of two layers of lipid molecules, each layer only one molecule thick. The hydrophobic ends of the molecules point inwards and the hydrophilic ends outwards. The original model by Danielli and Davson (1935) put the

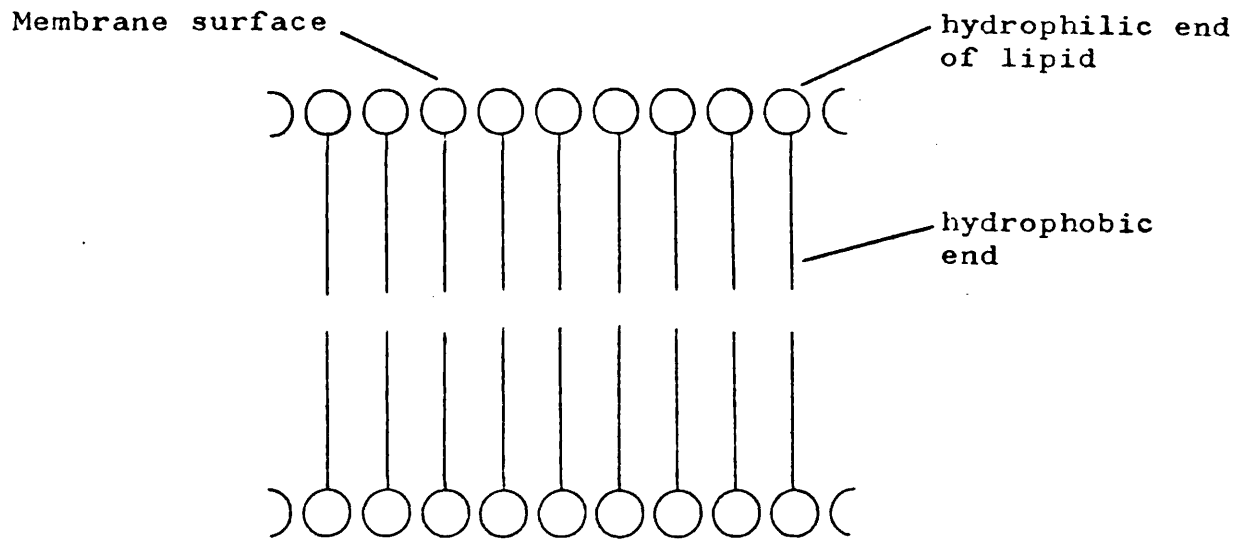

Fig. IX

Lipid arrangement of a plasma membrane

protein of the membrane outside the 'bimolecular lipid layer', however, it is now believed that the protein is intimately connected with the membrane structure.

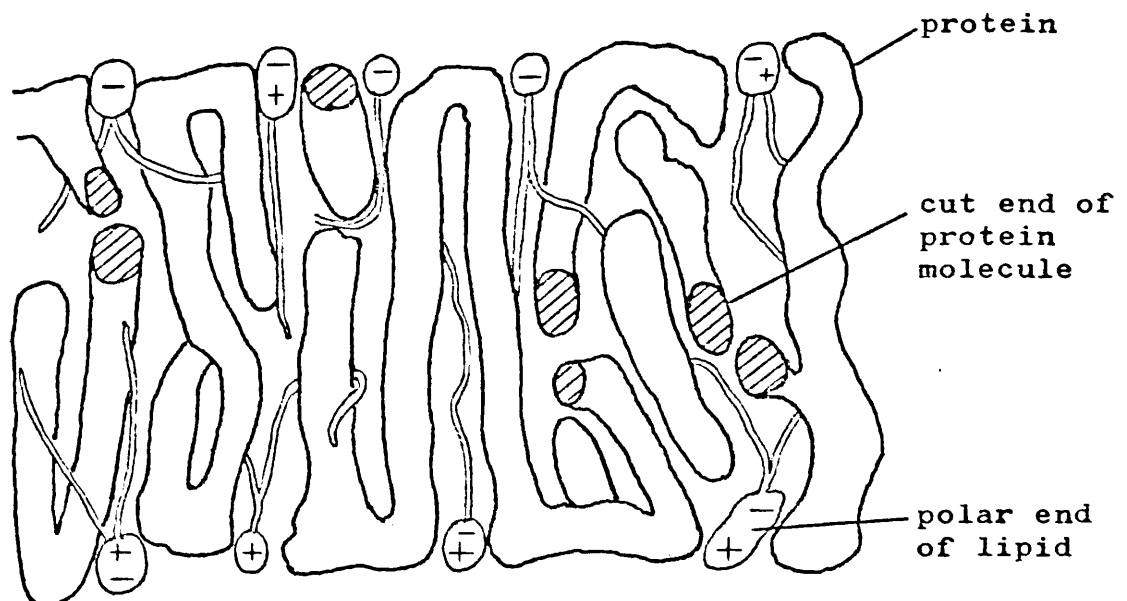

Fig. X Plasma membrane structure (Benson (1968))

As a consequence of this structure inorganic ions cannot diffuse freely through the membrane and, in fact, the plasmalemma is a very efficient barrier to free entry of ions into the cell. Very different concentrations of ions may be separated by the plasmalemma.

1.4 Essentiality

Certain heavy metals have been found to be essential for the normal growth, function and reproduction of plants and plant cells. Arnon (1950) suggested a series of criteria which a metal must obey if it is to be considered and essential element. They are:-

- 1) An organism cannot complete its life cycle without it
- 2) Its action must be specific and cannot be replaced by any other
- 3) Its effect on the plant must be direct.

This series was effectively modified by Nicholas (1957) in complaining that chlorine was clearly an essential element, but could be replaced by either bromine or iodine. It was an essential element in that a biochemical role could be found for it and restriction of entry by the element produced a large reduction in the growth of the plant. Now although the element may be replaced by other elements, it is chlorine which is found in nature in assimilable form and not iodine or bromine. Hence by terming the element a 'metabolism nutrient' he was able to assign essentiality to chlorine.

Further modification of Arnon's criteria occurred because of the success of many workers in finding a unique

metabolic role for the elements. The accepted criteria today are just two in number.

- 1) An organism cannot complete its life cycle if it is supplied at sufficiently low concentrations
- 2) It is part of the molecule of an essential plant constituent or metabolite (Epstein (1965)).

If an element obeys either of these two criteria then it is considered essential.

The elements so far found to be essential by these criteria are carbon, hydrogen, oxygen, nitrogen, phosphorus, sulphur, potassium, magnesium, iron, manganese, zinc, copper, calcium, boron, chlorine, molybdenum and for some plants sodium, selenium and silicon. These elements may be satisfactorily divided into two groups according to the quantity of the element required by the plant. If relatively large quantities of the element are required, for example between 1,000 and 45,000 ppm in dried plant material, it is called a macroelement. If relatively small quantities of the element are required, between 0.1 and 100 ppm of metal, it is called a microelement (Stout (1961)). Of the essential elements listed above, boron, copper, chlorine, iron, molybdenum, manganese and zinc are micronutrients. The heavy metals considered in this thesis, copper, iron and particularly zinc are thus essential micronutrient elements.

1.5 Copper, iron and zinc metabolism

Bowen (1966) has classified the functions of the essential elements into four categories:-

- a) Electrochemical

- b) Catalytic
- c) Structural
- d) Miscellaneous

Briefly, electrochemical functions are provided by metals present in cell solution as ions, and include charge neutralization of dissociated acids, other nucleophiles and colloidal particles, the build-up and breakdown of the structure of water and the provision of free energy during cell stimulation.

Catalytic functions in the cell by essential metals refers to the action of enzymes, either by metal activation of enzymes or by metallo-enzymes. Copper, iron and zinc are primarily involved in this category.

Examples of structural functions of particular metals include the case of magnesium which is essential for the stability of ribosomes, and calcium and iron which are vital for the structures of chromosomes (Bowen (1966)). Calcium in pectates is essential for the structure of angiosperm cell walls.

A whole variety of functions are included in the fourth category, for example magnesium present in chlorophyll possesses a function not included in any of the other categories, namely, being an integral part of a molecule which has the essential property of absorbing energy from sunlight in photosynthesis. Iron is present in cells as cytochromes which are involved in oxidations and reductions in plant metabolism; pollen tubes of *Antirrhinum majus* grow towards a source of calcium, i.e. the ovules (Mascarenho and Machlis (1964)).

Copper has primarily catalytic functions in the plant.

It has been found to be the prosthetic group in many enzymes and a component in many more. The important copper containing enzymes are ascorbic acid oxidase, p-phenylenediamine oxidase, cytochrome oxidase, polyphenol oxidase, laccase, indoleacetic acid oxidase (Wagenknecht and Burris (1950)) and many others. Copper also acts as an activator, cofactor and regulator of many other non-copper containing enzymes. It also exhibits other miscellaneous functions, for example, it appears to prevent an accumulation of iron in the nodes of corn plants (Brown and Holmes (1955)) and it is involved in respiration and the light reactions of photosynthesis. Copper appears to have no structural or electrochemical functions.

Iron also exhibits a great many catalytic properties in the plant. The iron containing compound most investigated in plants are the iron porphyrins (hemes) (Marks (1969)). Enzymes possessing iron porphyrins as either the prosthetic group or part of the protein itself include peroxidases, many dehydrogenases, catalase and others. Their primary role, however, is as carriers in electron transport. Iron is of course present in many non-porphyrin structures which are vital to the metabolism of plant cells, ferredoxins are an obvious example. Most of the iron found in plant material is present in the chloroplasts, however, and iron is known to be intimately involved with the synthesis of chlorophyll. Deficiency of iron results in chlorosis.

Zinc also has many catalytic functions. It is present as the prosthetic group in many enzymes, particularly dehydrogenases, for example, lactic dehydrogenase and alcohol dehydrogenase. It is also present in many enzyme activators. It appears to be essential in the biosynthesis

of indoleacetic acid (auxin) so that zinc deficiency has a drastic effect on normal growth of a plant, giving rise to 'little leaf' and 'rosetting'. Protein synthesis and chloroplast structure are also affected by zinc deficiency.

Hence the three elements copper, iron and zinc have a variety of vital functions in the living plant and are very decidedly essential elements.

1.6 Take-up mechanism

All normal living plant cells require a supply of the essential elements and for simple organisms, e.g. algae, this is easily achieved as they are in intimate contact with a solution of the ions. For higher plants, however, the vast majority of the cells are separated from the nutrient solution and a sophisticated ion transport system has to be employed. Briefly, this system operates as follows -

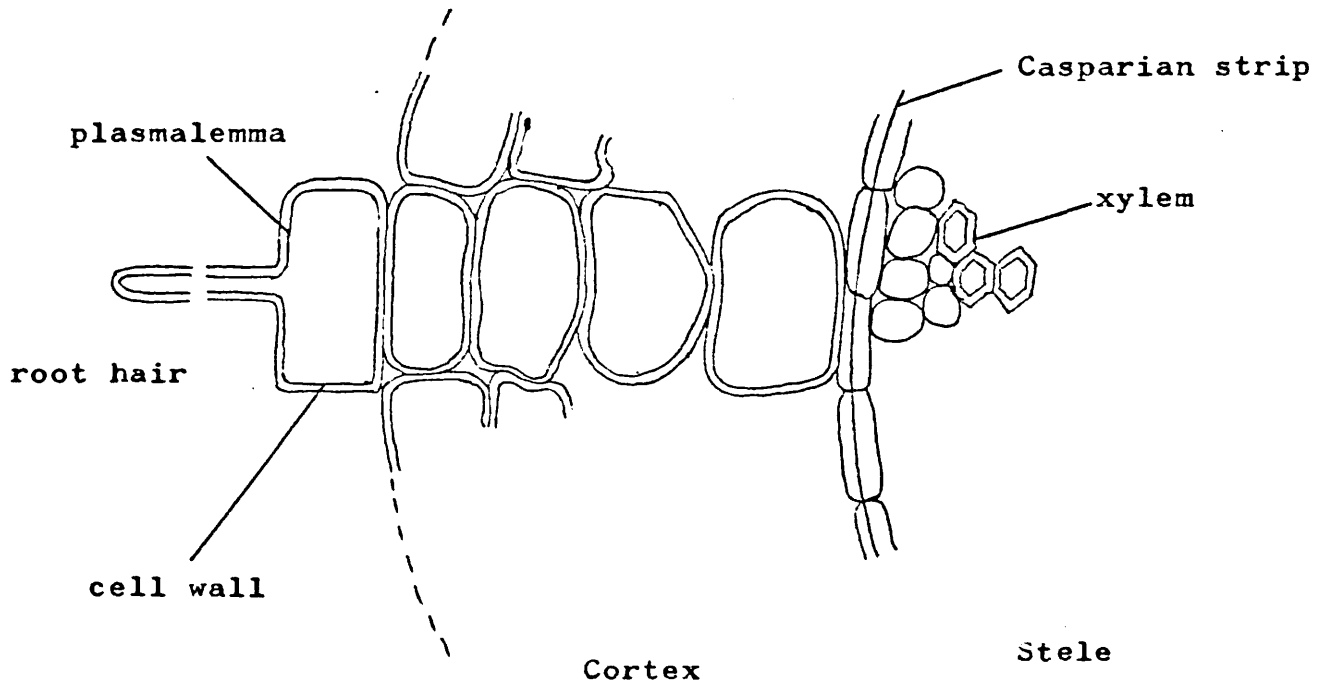

Cross-section of root-hair region of a generalized higher plant

Fig. XI

The metal ions in the soil solution can diffuse right into the cortex of the root and into the cell walls of the root hairs and cortical cells where they may be adsorbed onto the pectin, cellulose and other polysaccharide structures present. Ions adsorbed onto the cell walls are easily displaced by other ions. Further diffusion into the root ceases at the endodermis where the Casparian strip, a wax-like sheath in the endodermal cell walls acts as an effective barrier. In addition, the ions cannot diffuse into the cells of the cortex because of the presence of the cell membrane, the plasmalemma, which restricts entry. However, they can gain access to the cells by active transport via a carrier across the membrane. In this process an essential heavy metal ion comes into contact with part of the cell plasmalemma. It complexes with a proteinaceous constituent of the plasmalemma (carrier) and this large molecule crosses the membrane. By rotation or other rearrangement the ion is brought to the inner surface of the membrane where it is released, the carrier undergoing a change in configuration and returning to the outer surface. This method of ion transport differs from diffusion in that it requires energy from the plant, it is highly specific for the ion, it is irreversible and it obeys the Michaelis-Menten equation, i.e.

$$\text{Rate of absorption, } v = \frac{V_{\max} [s]}{K_M + [s]}$$

where V_{\max} is the maximum rate of absorption, $[s]$ is ionic concentration and K_M is the Michaelis constant (concentration of the ion giving half the maximum rate of absorption).

This equation has been found to hold for ion uptake in both intact plants (Chaudry (1971) and in plant parts (Bowen (1969), Carter and Lathwell (1967) and Smith and Epstein (1964)). As can be seen by the equation, the rate of cation absorption is independent of anion concentration.

Once inside the plasmalemma, the ion is released by the carrier (which is then free to capture another ion) and is then carried along in the symplasmic stream from cell to cell through the plasmodesmata. The cytoplasm within which the ion is moving is continuous through the Casparian strip so that the ion can gain access to the stelar cells. Close to the xylem vessels within the stele the ions are pumped out, again by an active process requiring specific carriers, and taken up in the transpiration stream. This carries ions to the rest of the plant where they may be absorbed by cells via a third active transport system. This, then, is the widely accepted mechanism by which cells of higher plants, remote from nutrient solution, receive their essential mineral elements (Epstein (1973)).

From the Michaelis-Menten equation it may be seen that the rate of uptake varies with increasing ion concentration according to OB in Fig. I, that is, the change of rate of absorption decreases until V_{\max} is reached when the carriers are working to capacity and further increase in metal solution concentration produces no further increase in metal uptake rate.

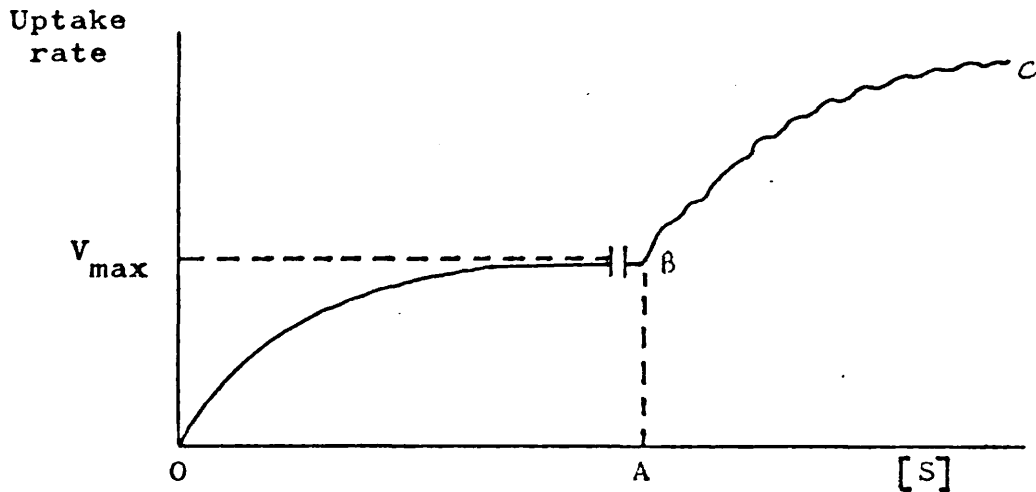

Fig.XII Plant uptake rate against solution ion concentration
(Epstein 1972)

However, as may be seen from the graph, on substantially increasing the nutrient solution in concentration, at a critical point A, the uptake rate begins to climb again, above the value of V_{max} . The first step, OB, represents the specific metal active transport described above. The region BC does not obey the Michaelis-Menten equation and the uptake is not ion specific. The interpretation of the shapes of the curves are still a matter of some controversy. Nissen (1971) suggests a multiphase mechanism of uptake, Epstein (1966) a dual phase mechanism located at the plasmalemma and Laties (1969) a dual mechanism located at the plasmalemma and the tonoplast.

From the Michaelis-Menten equation it can be seen that the rate of absorption is dependent on three fundamental entities: V_{max} , which is a measure of capacity, the rate of uptake when all the carrier sites are occupied; K_m , the intensity factor, corresponding to the fraction of all sites occupied at a specific concentration of ion, and $[s]$, the

ionic concentration in solution. In strictly controlled hydroponic conditions the values of these three depend on the species of plant, the ecotype, the recent history of the parent plants, the plant's age, the light source, its wavelength and intensity, the temperature, the chemical composition of the nutrient solution, the effect of bacteria, the shape and capacity of the hydroponics vessel and others. A plant growing naturally is subject to most of these and a very large number of other external factors which will affect the three quantities in the equation and hence the rate of absorption. The soil particle size, the available metal concentration, soil pH, general conditions of the soil, its dryness and aeration, the concentration of competing ions, the weather (humidity, temperature, sunlight), drainage, competing flora and many more all affect the metal uptake rate.

Hence the situation is one of a highly complex interaction of a vast array of factors yielding a final, probably variable, uptake rate and a changing metal concentration within plant tissues. Any discussion of rate of uptake and metal plant tissue concentration is therefore a necessary generalization of affairs.

1.7 Toxicity

The concentrations in the plant of the micronutrient elements considered adequate for healthy plant development are very small. Epstein (1965) has calculated that, on average, copper must be at a concentration of not less than 6 ppm in the dried plant material, zinc must be present at a level not less than 20 ppm and iron not less than 100 ppm.

However, in general, the concentrations of these elements found in plants are considerably higher than the levels given above. For example, Cannon (1960) gives average concentrations found in ashed plant material as copper 183 ppm, zinc 1400 ppm and iron 6740 ppm which, even assuming a weight loss in ashing of 95%, converts to copper -9 ppm, zinc -70 ppm and iron -337 ppm for dried plant material. Clearly the samples possess considerably more of the micronutrients than they require and this for plants grown on non-mineralized soils. On highly mineralized soil these values can be incomparably greater - for example, Crotalaria nova hollandiae leaf samples have been found to possess zinc at concentrations of around 9000 ppm (chapter II).

Bradshaw, McNeilly and Gregory (1965) stated that plants possess no mechanism for keeping specific heavy metals from their tissues. Thus, growing a plant in a nutrient or soil solution of high metal concentration results in higher than normal metal uptake rate. This is unfortunate because iron, zinc and particularly copper in anything other than low concentrations are toxic to plant cells. Thus, subjecting normal plants to unusually high concentrations of these metals in soil solution usually results in metabolic disruption, growth abnormality (normally retardation) and often death.

Copper, zinc and iron may poison plant cells in a number of ways but the primary mechanism of toxic action appears to be attack on essential enzymes (Hewitt and Nicholas (1963)). Copper in particular has an affinity for amino, imino and sulphhydryl groups which are known to be the prosthetic groups in many enzymes. In addition, copper

is believed to be an inhibitor of photosynthetic electron transport in chloroplasts (Cedeno - Maldonado et al. (1972)), at high concentrations of copper, iron appears to precipitate out of solution in the plant as iron phosphate, this induces chlorosis (Daniels, Stuckmeyer and Peterson (1973)). Copper has also been found to combine with cell membranes and affect their permeability (Passow et al. (1961)).

Zinc and iron are not as toxic as copper but nevertheless unusually high concentrations of these metals in plant tissues do result in severe metabolic disruption. It is probable that zinc toxicity occurs in a number of ways. It is well-known for instance, that in many plant species increase in zinc tissue concentration induces chlorosis due to iron deficiency. Painting leaves with an iron salt results in chlorophyll again being produced. The mechanism for this effect is not known but it is relevant that the degree of toxicity of metals increases in general with the stability constant of heavy metal organo-metallic complexes (Hochster-Quastel (1969) and De Kock (1956)).

1.8 Tolerance

On Serpentine and other mineralized soils and on mine tips, vegetation tends to be sparse, most plants either succumbing to the toxicity of the metals or failing to survive due to diminished ability to compete with other plants. However, some plant species and ecotypes resist the effects by possession or evolution of a tolerance mechanism. Monocotyledons in general tend to resist metal toxicity rather better than dicotyledons probably because their roots are adventitious, they replace their roots continuously without

harming the plant. In addition, their critical point concentration levels tend to be much higher than dicolytedons (Howard-Williams (1970)).

Some species growing on mineralized ground have been found to have developed an affinity for a particular metal e.g. Astragalus stoloniferii for selenium (Cannon (1960)) and Thlaspi alpestre ssp calaminaria for zinc, where the metal is often present in the plant tissue in very high concentrations. These species are called accumulator plants (Beeson et al. (1956)). Others have metal levels which correlate well with the soil metal levels and such plants are called indicators. They have been used in the prospecting of ores (Chikishev (1965), Victorov et al. (1964)). These plants are all metal tolerant.

Antonovics, Bradshaw and Turner (1971) have reviewed the possible mechanisms for heavy metal tolerance in plants. They are:-

- | External | Internal |
|---|---|
| 1) Form of metal is not soluble in water and/or if dissolved is rapidly diluted by surrounding water. | 5) Differential uptake of ions. |
| 2) Actual amount of freely diffusible metal ions is small compared with total amount present. | 6) Removal of metal ions from metabolism by deposition in the vacuole. |
| 3) Lack of permeability to heavy metals under specific conditions. | 7) Removal of metal ions from metabolism by pumping from cell. |
| | 8) Removal of metal ions from metabolism by rendering into an innocuous form. |
| | 9) Excreting mechanisms - removal by "metal storage |

4) Metal ion antagonisms

organ".

- 10) Greater requirement of enzyme systems for metal ions.
- 11) Alternative metabolic pathway by-passing inhibited site.
- 12) Increased concentration of metabolite which antagonizes inhibitor.
- 13) Increased concentration of enzyme that is inhibited.
- 14) Decreased requirement for products of inhibited system.
- 15) Formation of altered enzyme with decreased affinity for inhibitor or increased relative affinity for substrate compared to the competitive inhibitor.
- 16) Decreased permeability of cell or subcellular units to metal ions.
- 17) Alteration in protoplasm so that enzymes may function even when toxic metals replace physiological metals.

These various mechanisms reduce to three major types:-

a) metal is not taken up by the plant, b) metal is taken

up but rendered harmless to the plant metabolism and
c) the metabolism alters, thus rendering the plant unaffected
by the large levels of metal present.

Type (a) mechanisms have not been considered here, those plant species with low metal levels were discarded in this investigation. Type (c) mechanisms are also of relatively little importance in this work as the metal levels are so high in the tissues that although some change in the metabolism is possible, tolerance is unlikely to be conferred on the plant by this method alone. The metals must be rendered ineffective. Howard-Williams (1970) states that when a relatively metal tolerant plant is growing in soils of increasing available metal content, the metal level in the plant tissue stays low until the critical soil concentration when the metal level in the tissue increases very quickly (see Take-up mechanism 1.6). Thus there are two factors in tolerance; 1) the critical level and 2) the treatment of the increased metal levels in the plant tissue. On this model the samples investigated here may well have passed the critical level as they are dicotyledons with relatively high metal-tissue concentrations. However, the overriding question is, how do the tolerant plants render the metal passive to metabolic disruption?

As stated (section 1.7) metal toxicity is caused chiefly by chelation by enzymes resulting in the inability of the enzymes to function properly. If the metal level is high enough death will result. Tolerance of type (b) must thus involve prevention of contact between the toxic metal ion and the enzymes that can be affected, and this itself involves two possibilities, either 1) the metal is bonded

in a complex of high stability constant so that exchange of ligand with the enzymic prosthetic group can occur only to a very limited extent or 2) the metal is spatially separated from the main susceptible metabolic sites, i.e. mitochondria and ribosomes (Rao et al. (1966)).

A number of tolerance mechanisms of both types (1) and (2) have been observed. Rathore, Bajaj and Wittwer (1972) found a low zinc uptake rate in zinc tolerant Phaseolus vulgaris. Here zinc was deposited in the cytoplasm in the tolerant plant and in the nuclei and mitochondria in the zinc sensitive plant. Earley (1943) found that zinc tolerant soybean restricted entry of the metal. This has been discredited by implication from the assertion made by Bradshaw, McNeilly and Gregory (1965) that tolerance by restriction of entry had not been demonstrated. Epstein (1972) supported this assertion. Howard-Williams (1970) suggested, however, that plants did restrict entry, not by reducing carrier activity but by increasing it to its maximum capacity. Increasing nutrient solution metal concentration up to the critical value results in no increase in uptake so that uptake rate is lower than expected from the solution ion concentration.

Other observed tolerance mechanisms based on the spatial separation of metal ions and metabolic centres include a series of papers by Turner, Marshall, Bradshaw et al. which demonstrate the importance of the cell wall as an accumulation site for zinc, copper and lead in the roots of the species Agrostis tenuis. Hammett (1927) and Cannon (1960) have demonstrated tolerance to lead, uranium and vanadium involving this same mechanism.

There are a great many examples of tolerance whereby a metal is restricted to a particular plant part (rather than cell structure). The metal may be restricted to roots as in copper in Becium homblei (Reilly (1967, 1969)), in a variety of metals in plants quoted by Ernst (1965) and in lead and copper in Australian species quoted by Nicols, Provan et al. (1965). Dykeman and de Souza (1966) described copper tolerance of a species in a swamp forest which involved the plant concentrating the metal in its leaves which were then shed or burned, thus ridding the plant of the high copper burden. Ecbolium lugardae reported here appears to concentrate lead in primary branches, emanating from the stem, rather than in the roots, stem, secondary branches, flowers, or leaves. All these phenomena serve to decrease the general level of the toxic metal available to plant cell metabolic sites.

The best known example of tolerance by inert complexation is that of Astragalus species in Serpentine soils which employ amino acid combination with selenium to resist the metal's toxicity (Cannon (1960)). Amino acid complexes are also employed in the copper tolerance of Saccharomyces ellipsoidus (Arakatsu and Ashida (1956)) which was able to synthesize glutamic acid in the presence of copper. Reilly (1969) found copper strongly complexed with proteins in the cell sap of roots of Becium homblei. Jones (1961) demonstrated aluminium complexed with organic acids in roots. For cases of tolerance by complexation there is no necessity for the metal to be restricted to various plant parts or cell structures. The metal complexes may be found in the cytoplasm, cell sap, intimately connected with mitochondria

and other delicate metabolic reaction sites; it is of no consequence, the metal has been rendered harmless.

Some species are naturally less susceptible than others to particular metal toxicity. Halophytes may take up high concentrations of sodium and other ions without adverse effect, and indeed many species have developed a necessity for sodium (Brownell (1968), Williams (1960)). Species are also able to evolve a tolerance to metal toxicity. Bradshaw (1952) described how clones of Agrostis tenuis growing on highly mineralized mine tailings exhibited a metal tolerance that other clones of the species did not possess. This evolution of tolerance is absolutely specific for the particular metal. For example, Jowett (1958) found that for the species Agrostis tenuis and Agrostis stolonifera growing on sites where one heavy metal predominated, evolutionary change resulted in the plants being tolerant to that one metal and no others. That is, tolerance to one metal does not confer tolerance to others; it is specific. In fact, the evolved mechanism appears to be even more specific than metal uptake across a cell membrane. In certain cases zinc and copper have been found to use the same carrier to cross the plasmalemma (Bowen (1969)) but no cases have yet been reported where an evolved tolerance to one metal confers tolerance to another. Broker (1963) working with Silene inflata also confirmed tolerance specificity for this species.

Much of the work reported above on tolerance has been restricted to the study of roots, root growth being a measure of tolerance (Wilkins (1960)). Root growth and metal behaviour in roots may be studied when the plants are grown hydroponically but it is difficult when plants growing

in high metal areas are collected in the field. Also, in many plants (Howard-Williams (1970), Ernst (1969) and Dykeman and de Souza (1966)) metal is accumulated in leaves which are then shed in the autumn, thus ridding the plant of much toxic metal. Here the tolerance mechanism would be found in the leaves rather than the roots. This would also be the case for a metal present in high concentrations in leaves, where toxic action involved disruption of photosynthesis or other leaf function. In addition the aerial parts of many plant species have been employed as 'indicators' of soil metal levels. How may these cells, which possess such high concentrations of toxic metals, resist their poisonous effects? Thus for this work mainly aerial parts of mineralized plants are examined.

1.9 Cell wall as accumulation site

In many investigations into tolerance the cell wall has been implicated as the metal accumulation site (if not the actual tolerance mechanism). Turner (1970) found that the root cell walls of tolerant Agrostis tenuis possessed higher levels of the particular metal than the non-tolerant plants and Gregory (1964) in a rather different context had findings consistent with this. Also Cartright (1966) found 64% of the total copper in subterranean clover nodules located in the plant cell walls, and Diez-Altare and Boroughs (1961) and Diez-Altare and Bornemisza (1967) observed that at normal zinc levels, up to 44% of the total zinc in germinating corn tissues was localized in the cell wall. Hence the plant cell wall has certainly been found to possess the ability to accumulate metals.

In view of the chemical composition of the cell wall this should hardly be surprising. Uronic acids in cell walls have been identified as the medium of cation exchange. Mattson et al. (1949) noted that uronic acids of the pectin in cell walls possessed cation exchange capacity. Dainty and Hope (1959) also demonstrated the ability of pectin and uronic acids in cell walls to bind metal ions by cation exchange. Turner (1967) found zinc associated with carbohydrate in cell walls and with pectin in particular. Diez-Altare and Bornemisza (1967), however, found zinc bonded with hemicellulose and protopectins in the cell wall fraction. Peterson (1969) found zinc in the cell wall associated with pectin. Knight, Crook and Inkson (1961) found that the cation exchange capacity of plant material was proportional to the uronic acid concentration.

Cation exchange involves electrostatic attraction between the metal ion and the uronic acid anion. Although metal ions may be listed in order of cationic exchange ability (Lyotropic series), the process is not very specific, any metal may displace any other provided it is in high enough concentration. Uronic acids may also bind metal ions by complexation. Here hydroxyl groups of the uronic acids are also employed in bonding (Schweiger (1966)) and the metal is less easily replaced by other ions.

In the majority of work done on metal tolerance in higher plants, the mechanism consists of spatially separating the metal from sensitive metabolic reaction sites. In this the cell wall has been implicated as the alternative accumulation site; it possesses the necessary ability and capacity.

As noted in section 1.8 on tolerance a striking feature of

this type of tolerance mechanism is its absolute specificity for the particular metal involved. Bradshaw et al. (1965), Gregory and Bradshaw (1965) and Turner (1970) all working with Agrostis tenuis found that plants grown on mine tips containing one metal developed a tolerance to that metal and possessed no resistance to the toxicity of another metal. In addition Turner (1970) noted that the distribution of one metal amongst the cell structures is unaffected by the alteration in the concentration of the other metal. Broker (1963) working with Silene inflata also affirmed that tolerance to one metal does not confer tolerance to another.

Turner and Marshall (1971) found "a rigid specificity for zinc by the cell wall material of the zinc tolerant plants", suggesting that as water and ions move through the cell walls to the plasmalemma the metal for which the plant possesses a tolerance is specifically filtered out. Thus a much lower level of the metal will come into contact with the ribosomes and mitochondria. With this model, however, it is difficult to see how the tolerance is so ion specific. Absolute specificity is generally believed to be exhibited only by proteins (Bayer (1964)). No large scale bonding of metals to proteins in cell walls has yet been observed in tolerance studies. The bonding of metals in cell walls has been consistently with carbohydrates.

The manner in which the bonding to the carbohydrates occurs is also very non-specific. Turner and Marshall (1971), Dainty and Hope (1959), Findenegg and Broda (1965) emphasize that uptake of a heavy metal by cell walls was a passive ion exchange process. This is notoriously non-specific and quite inconsistent with the completely specific character of heavy metal tolerance.

Turner and Marshall (1972) recognized this problem in attempting in vain to correlate tolerance index (Wilkins (1960)) and nitrogen content of the cell walls. In addition they found that though there was a rough correlation between tolerance index and cell wall metal binding capacity, there was no rigid specificity. For a number of plants there was no connection between degree of tolerance and the binding capacity of the cell wall for the specific metal. Hence, for these the theory of specific ion exchange on carbohydrates cannot hold at all.

However, if it is assumed that the mechanism of tolerance is located, not at the cell wall which is merely the accumulation site, but at the plasmalemma, several alternative mechanisms are possible. At a given concentration of metal ion solution the rate of transport of the ion across the plasmalemma is decreased if the critical concentration is high, V_{\max} in the Michaelis-Menten equation is decreased and K_M is increased. Rathore, Bajaj and Wittwer (1972) actually found a decreased uptake rate in metal insensitive Phaseolus vulgaris over the metal sensitive strain. In general this would result in a build-up of the metal in the cell wall, not primarily because the cell wall had a specific affinity for the metal but because there was a greater concentration of the metal at the cell wall than for the non-tolerant plant. This is exactly what is observed.

The rate of absorption across the plasmalemma for a particular metal may be decreased by one of three methods:-

- a) The number of specific carriers could be decreased
- b) The rate of reaction of the carrier could be

decreased

c) An efflux carrier could increase in number or rate of reaction (Poole (1969)).

In any event the plasmalemma would effectively decrease the ability of a specific metal ion to cross permanently into the cell.

This would explain the decreased rate of absorption, the build-up of metals in cell walls; the tendency of root-shoot metal ratios to be greater in tolerant plants (where accumulation occurs at cell walls) and, particularly, the great specificity of tolerance.

1.10 Complexation

Of great chemical and botanical interest is the complexing of metals by natural ligands in plants and, as noted in section 1.8 this method has been observed as a metal tolerance mechanism in plants. Selenium (Cannon (1960)) and copper (Arakatsu and Ashida (1956)) have been found to form non-labile, stable and soluble amino acid compounds which render several plant species examined immune to high levels of the elements. In this respect copper has also been found bonded to proteins (Mills (1954)) and polypeptides and amino acids (Reilly et al. (1970)).

Possibly because of the great practical difficulties involved (see section 1.11) very few soluble heavy metal complexes have been identified in plant tissues. Indication of bonding types have been given, notably by Ennis (1962) and Timberlake (1959) who found metals bonded with phenolic hydroxyl and carboxylic acid groups, and Schmidt and Gerloff (1961) who found an iron chelate in xylem exudate.

However, one of the earliest and most noticeable identifications was that of Tiffin and Brown (1962) who identified an iron citrate anion in the exudate of sunflowers. It is clear that iron cannot travel up the xylem as the ferrous ion because the pH is above that at which hydrolysis of the ion occurs to give an insoluble hydroxide. Hence, it must be transported as a soluble complex. Copper may also enter this category.

Lingle, Tiffin and Brown (1963) found uncomplexed zinc ions in soya bean exudate and Tiffin (1967) again also found uncomplexed zinc. Tiffin (1966) discovered iron malate and maleate complexes in plants. Lyon, Peterson and Brooks (1969) identified chromium present in roots as a trioxalato anion. Manganese has been discovered as complexes of galactosyl-diglyceride, linoleic acid and flavine by Udel'nova and Boichenko (1967). Finally, Hoefner (1968) found that some plant species transport zinc as amino acid complex anions and uncomplexed metal cations.

1.11 Practical techniques and difficulties

a) Metal Concentration

Water is the major constituent of higher plant material usually exceeding 85% of fresh weight. This may be removed by heating the fresh material in an oven at 70°C for about 24 hours. Of the remaining material approximately 90% is cell wall material comprised mainly of cellulose and other carbohydrate polymers (see section 1.2) and having the empirical composition $C(H_2O)$. Hence, the inorganic fraction of cell wall material rarely exceeds 1.5%

of total weight (Epstein 1972).

It is clearly of fundamental importance in plant-metal work to be able to determine concentrations of metals in plants, plant parts and in extracts. A number of techniques are available for analyzing metals of which the atomic absorption spectrophotometer is the most widely employed. It is very quick and simple to use and is of high sensitivity. One of the drawbacks of the technique, however, is the fact that the sample may only be analyzed one element at a time and that an expensive lamp must be purchased for each new element to be analyzed. The method has been modified for greater sensitivity by substitution of the flame by a flameless atomizer. In this adaptation the metal under investigation is atomized and reduced using a carbon rod, electrically heated to white heat, instead of the normal flame. In this case ashing of extracts is not required, the solution may be placed directly on the rod. Solid material however, must still be wet ashed with nitric acid before application of the technique.

Of the latest techniques in analytical chemistry the most promising as regards plant metal analysis is that of atomic fluorescence. In this technique up to seven elements may be examined at one time, each element to a far greater sensitivity than in absorption, there is less noise and all suitable elements may be assayed on the one machine (i.e. no specific lamps must be purchased before an element can be determined).

The technique used mostly in this thesis is that of wet ashing the plant material or extract with concentrated nitric acid until the solution is clear and colourless,

diluting to a volume and analyzing on the atomic absorption spectrophotometer. The flame used was exclusively air-acetylene (see appendix). The flameless atomizer was also employed on one occasion. In most cases direct comparison with standard aqueous solutions was used though the method of standard additions was also employed.

As mentioned in section 1.6 the rate of metal uptake depends on a great many factors, the concentration of a metal within a plant part depends on these and many more factors. However, despite the fact that absolute metal concentration is variable and the resultant of a highly complex interplay of factors, some important facts about the sample may be derived from information of plant metal levels. For example, the ability of a plant to concentrate and withstand metals in its tissues; metal-metal ratios and hence possible shared carrier mechanisms; and metal storage sites (leaves, flowers etc., Reilly (1960)) can all be derived from information on general metal levels. In any event extraction with solvents, chromatographic and other later work requires a knowledge of the total metal concentrations in the sample plant parts.

b) Antagonistic and Synergistic effects

Difficulties in interpretation of metal concentration results occur. From results obtained many workers have been able to build up a picture of interrelationships between the concentrations of various metals in the tissues of plants. The fact that the concentration of iron decreases with increasing manganese has long been known and copper, zinc and manganese have also been shown to be antagonistic in some

plant species (Smith and Specht (1953)). Many other interconnections are known.

The opposite effect, synergism (Prevot and Ollagnier (1957)), whereby feeding a plant with increasing concentrations of one element induces a corresponding increase of another metal, is also well known. Zinc and magnesium exhibit a synergistic effect in some species (Barrows and Gammon (1960)) and sodium and potassium in others (Prevot and Ollagnier (1961)). Again many others are known. These effects have also been noted in anions (Meyer et al. (1957)) and macroelements (Drosdorff et al. (1954)).

However, it has been suggested (Shear et al. (1953)) that more complete mineral analysis reveals far more profound changes in mineral content than those indicated so far. Smith (1962) tabulated results in citrus leaves and found, for example, that increase in the zinc level, although having no effect on nitrogen, phosphorus and boron, increased the potassium concentration and decreased the concentrations of calcium, magnesium, copper and manganese.

These interrelationships apply to normal nutritional levels of plants and are not easily extended to tolerant, indicator and accumulator plants which may possess a very high concentration of one particular element. It has been stated (Peterson (1969)) that for Agrostis tenuis alteration of the concentration of the element to which the plant is tolerant does not effect the level and distribution of the other metals. However, for other elements some relationship may well be expected.

c) Extraction schemes

In chapter II a number of plant species are examined for their metal concentrations by the method described in section 1.11 (a) and some of them are found to possess relatively high concentrations of one metal or another. The information obtained, however, from metal levels in plant material is limited, in that the level of, say, iron in plant leaves is the sum of all the iron containing compounds present in the plant, e.g. proteins, pectates, the citrate anion, simple complexes, porphyrins etc. More information of the actual chemical nature of the iron present may be obtained by an analysis of the types of chemical compound in which the metal is bonded. The easiest way to do this is by solubility studies using different solvents.

A number of different extraction processes have been attempted with great success. Bowen, Cawse and Thick (1962) fed tomato plants with radioactive ions and extracted the plant material with a series of reagents. Bremner and Knight (1970) examined the zinc in ryegrass by extraction with various solvents and then peptic and fungal cellulose digestion. Peterson (1969) examined zinc in Agrostis tenuis by extracting with boiling 80% ethanol and then boiling water; the ethanolic solution was extracted with ether. The scheme proceeded by the digestion of the residue in the enzyme pronase. Reilly (1969) extracted with dioxan, butanol and methanol before water but was criticized by Ernst (1970) because the dioxan removed some water-soluble compounds. Ernst himself used butanol, then water, then sodium chloride and citric acid as ion exchangers before extracting with dilute hydrochloric acid. Diez-Altare (1967) employed a broadly similar scheme

to that of Peterson (1969).

The present work required a quick, reliable, routine analysis giving the maximum of information. None of the schemes mentioned above was completely suitable; Peterson's scheme was long and involved, but was employed later with particular selected plants; Bowen, Cawse and Thick's method used perchloric acid which was considered ill-advised for routine work.

The extraction scheme finally devised was a straightforward sequential scheme based on a series of solvents of increasing dielectric constant giving comparatively little overlap of fractions from one solvent to another. It gave a broad separation of chemical compound types and these could be listed for each solvent. This useful, informative, relatively uninvolved, if limited, scheme (see chapter III) was hence applied to all the plants examined. In fact, the final scheme developed into a system similar to that of Bowen, Cawse and Thick (1962). A higher concentration of alcohol was present in the aqueous alcohol than in their system, ether was extracted first rather than later, and ashing was performed with concentrated nitric acid rather than with a nitric-perchloric acid mixture as in their scheme. Other extraction schemes and modifications were also employed for selected plants, most notably for protein determination in chapter II and examination of insoluble metal in chapter III.

As would be expected, literature values of metals soluble in various solvents and present as various chemical compound types in plants are highly variable. For example, for corn tissue Bremner and Knight (1970) found 60% of zinc present as low molecular weight compounds soluble in 80% aqueous

ethanol, very little zinc was present as protein. However, Diez-Altare and Bornemisza (1967) found 44% of zinc present in high molecular weight hemicelluloses and protopectins in the cell wall of corn tissue with most of the soluble zinc present as the protein. Helen Cannon (1960) found the majority of selenium in selenium tolerant Astragalus species as a water soluble, low molecular weight compound (amino acid complex). Turner (1970) found most of the copper in copper tolerant Agrostis tenuis in the dilute acid-soluble fraction (as the pectate). Ernst (1969) found most of the zinc in zinc tolerant species as a water soluble, non-amino acid complex (in the cell sap) and Rathore, Bajaj and Wittwer (1972) discovered most of the zinc in zinc tolerant Phaseolus vulgaris also as a water soluble compound (though this time in the cytoplasm rather than cell sap). Clearly, the dominant metal compound type in tolerant plants varies from species to species and metal to metal.

The plant samples examined here were for the most part highly mineralized. Investigation of their dominant metal compounds gives an indication of accumulation bonding if not their tolerance mechanism. The extraction scheme devised allows for broad comparison between the plants examined and the results reported above.

d) Examination of Soluble Compounds

These compounds tend to be of comparatively low molecular weight. They have been obtained for examination by collecting the plant exudate from the severed stem, crushing the plant to obtain the cell sap or, as in this case, by direct extraction with aqueous ethanol and water. The major soluble heavy metal

complexes so far identified and the researchers who performed the work have already been mentioned in the section on complexation (1.10).

The principal technique employed in all these studies was that of paper electrophoresis and chromatography with a radioactive isotope of the metal and occasionally radioactive carbon in the ligand. Generally, the electrophoretogram or chromatogram was placed in contact with a chromatographic plate which was then developed. Lyon, Peterson and Brooks (1969) employed a densitometer, however, giving a continuous line readout from the radioautographs.

For the electrophoresis work quoted above there was little similarity of conditions even when examining the same metal. Papers range from Whatman number 1 to 3MM, buffers from 0.05M acetate pH 5.4 to 1,3-iminodipropionitrile-acetic acid-formamide pH 5.9, and higher pH's, and there was considerable variation in times recorded for development. In the work reported in this thesis Whatman number 1 paper was used throughout using a voltage of 340V and 20 cm paper length and a variety of buffers and development times.

Workers examining metal complexes in plant material by chromatographic means have used Whatman 3MM paper and Whatman number 1 occasionally. Descending chromatography has been preferred to ascending and phenol-water (4 to 1 by weight) and butanol-acetic acid-water (12 to 3 to 5 by volume) have been used, among many others, as solvents.

A difficulty of interpretation of results arises in the case of zinc. In comparison with chromium, manganese, iron, cobalt and copper, zinc is a poor complexing metal. Many of its complexes are exceedingly labile. As regards dissociation

of zinc complexes the techniques of separation and identification particularly electrophoresis, are very harsh and lead to dissociation. A number of zinc complexes prepared have been found to dissociate quite spontaneously with the techniques applied. For example, a soluble unknown complex of zinc from plant material was found to dissociate not only in paper electrophoresis under different conditions, but even in passing down a chromatographic column packed with silica or cellulose. Hence, discovery of uncomplexed zinc in an electrophoretogram, of which there are a number of reports, ought not to lead to the automatic conclusion that zinc is present in the plant as uncomplexed zinc ions.

e) Examination of Metal Compounds Insoluble in Water

Often, particularly with plants which possess high metal concentrations in their tissues, a high percentage of metal is found to be insoluble in water. The type of compound with which the metal is associated then is probably one of the following:- proteins, pectates, nucleic acid, cellulose, lignin and other possible polysaccharides. Once again the easiest method of determining the distribution of a metal amongst these compound types is by solvent extraction scheme. There are a number of extraction techniques available for the purpose. There are those based on the scheme of Bowen, Cawse and Thick (1962) and Bremmer and Knight (1970) or Diez-Altare and Boroughs (1961), for example, but the extraction process preferred, because of the detailed information available, was that of Peterson (1969) involving enzyme digestion. The scheme is shown in tabulated form in the relevant section (chapter IV, page III). Peterson himself used the scheme to determine

in which insoluble fraction zinc is bonded in Agrostis tenuis. He found a relatively high concentration in the pectate extract.

The insoluble metal compounds in plants have only rarely been examined. When they are it tends to be this fraction, the pectate extract, which contains most of the metal, particularly for those metal tolerant plants that possess a high insoluble metal compound concentration.

f) Location of Metals in Plants (determination of accumulation site)

Having gained an idea of the bonding of a metal in plant tissue the next most important piece of information required is, where, within the plant, does the metal accumulate? A very rough idea will have been gained already from normal wet ashing of the plant parts. For example, it was noted in the section on tolerance that Ecbolium lugardae accumulated lead in primary branches; this was discovered purely by straightforward ashing of the plant parts, main stem, flowers, leaves etc.

Other techniques available for accumulation site determination are autoradiography, histochemistry, ultracentrifugation and electron probe microanalysis.

1. Autoradiography

This is the technique whereby a living organism is fed with a radioactive isotope, then killed and sectioned and then mounted in close contact with a photographic plate. After an exposure period of frequently many weeks, the film is developed, resulting in darkening of the film in areas in contact with the highest concentrations of radioactive isotope. Hence, a film record is obtained of where the

particular element in the nutrient solution is transported. This is a very widely employed technique with very many practical modifications.

For zinc accumulation in plants, however, relatively few microautoradiographs have been performed. This is because ^{65}Zn , the most common and readily available isotope of zinc, though greatly used in biological studies in general because of its convenient half life of 249 days, is a γ -emitter. γ -particles have very low photographic efficiency so that the area on the plate in contact with the source is not sharply defined but blurred. However, the isotope is still useful for "whole plant" autoradiography where high photographic efficiency is of minor importance. Here a plant is treated with the radioactive isotope in its nutrient solution (if grown hydroponically) and, after a period, it is then harvested and freeze dried immediately. The dried plant is then pasted to a card and left, often for several months, in contact with a photographic film or plate. The film is then developed to show the areas of roots, stems, leaves etc. of high concentrations of the radioactive source.

Because zinc is an essential element and its major roles in higher plant metabolism are mainly associated with growth, it has been found by a number of workers that ^{65}Zn fed to plants accumulates in the growing areas, i.e. the nodes of the stem at leaf junctions and at the newest growth, the ends of stems and at young leaves. The question arises, where does ^{65}Zn accumulate in a zinc tolerant plant which already possesses a high zinc level? In chapter IV an attempt is made to answer the question by this technique.

2. Histochemistry

This well-known and indeed classical technique has been found to be exceedingly useful in this study. The plant under investigation is killed, sectioned for the microscope and stained with one or more of a variety of chemicals to indicate, by colour, the presence of a particular chemical. In general the substance to be identified must be in high concentration for the colour to be seen and this fact has ruled out histochemistry from most heavy metal work with plants. However, in the field of tolerance, metals are present in relatively high concentrations so that in a number of cases their presence may be indicated.

Stains in histochemistry must give strong colours, preferably red or blue, with relatively low concentrations of the compound being investigated. Also the compound formed with the stain must be insoluble in water to avoid translocation. However, great care must be taken that the stain selected does not give a similar colour to other structures hence leading to erroneous conclusions. The best way of proceeding is by referring to the literature to obtain as specific a stain as possible.

Having obtained a suitable stain and procedure, a permanent slide may be made, or the section drawn or colour photograph^{ed} giving a permanent record of the accumulation site. It is curious that this relatively simple technique does not appear to have been used for heavy metal tolerance studies (though it has occasionally been employed for determination of metal accumulation sites, e.g. Smith (1953)).

3. Ultracentrifugation

This general technique for investigation of metal accumulation sites in plants involves feeding the growing plant with the radioisotope as in autoradiography, then harvesting the various plant parts, e.g. roots, leaves etc. and grinding them thoroughly in an homogeniser with a suitable buffer solution. The homogenised mixture is then centrifuged at various speeds for known times to separate the different cell constituents. These different fractions are weighed and radioassayed to determine in which structures the element is most highly concentrated.

It has been noted that in autoradiography the low photographic efficiency of zinc renders microautoradiography impracticable for this metal. However, this technique of ultracentrifugation serves as a good substitute for microautoradiography for determination of zinc accumulation sites of the cellular level (Rathore, Bajaj and Wittwer (1972)).

Many other workers besides the above have used this technique for the identification of metal accumulator sites in plants. Stocking and Ongun (1962) used it first for the location of K, Na, Ca, Mg, and N in chloroplasts. For the analysis of zinc Diez-Altare and Bornemisza (1967) employed a simple ultracentrifuge separation scheme followed by an extraction system for further fractionation. They found that for germinating corn most of the zinc (56%) was present in the final supernatant (after all the other structures have spun down) as a soluble protein. However, the rest of the zinc was found to occur in the cell wall pellet. This confirmed earlier work of Diez-Altare and Boroughs and others and is not unexpected. The plant was not a zinc tolerant

sample and the metal levels were relatively low.

Turner (1970), using a more sophisticated ultracentrifuge scheme, found that for tolerant Agrostis tenuis zinc was found predominantly in the cell wall and suggested this as the tolerance mechanism site. This tendency to accumulate excess metal at the cell walls was supported by Cartright (1966), who found 64% of copper in subterranean clover was present in cell walls.

In contrast, Johnson and Schrenk (1963) found most of the zinc in tomato plant leaves present in the soluble supernatant and very little indeed attached to cell walls. Kositzin and Igoshina (1964) also doubted the role of cell walls as metal accumulators, believing that the strong adsorption properties of the cell walls inflated metal-cell wall values after separation of cell wall material from a solution of metal ions. Rathore, Bajaj and Wittwer (1972), studying tolerant and non-tolerant Phaseolus vulgaris, found that for both types concentration of zinc in cell wall material was only 7% of the total. 75% of the zinc in both plants was found in the soluble supernatant. Here, tolerance appeared to lie in the ability of the tolerant plant to restrict entry of zinc into nuclei and mitochondria. These workers also quote Edwards, Olsen, Heggen and Glen (1961) and Thiers and Vallee (1957) as supporting their findings, though unless there was private correspondence, this interpretation is difficult to make from the respective papers.

The technique employed here is the one used by Turner (1970). It combines the least likelihood of overlap of the fractions with the greatest number of different structures separating out. The actual scheme is given in the relevant

chapter (see page 132).

4) Electron probe microanalysis

This useful, sophisticated technique was first used by Lauchli and Schwander (1966) and subsequently developed by Lauchli. It may be used to analyse the rough concentration of almost any element on the microscopic scale. Normally it is used to scan across a section of the plant material giving a continuous line readout; hence local concentrations of the element under examination may be identified. Unfortunately, because the technique may be applied only under high vacuum the plant material must be killed and dried. Hence, some translocation of the element may take place.

The general principle is that the dried plant material is sectioned giving a sample approximately $\frac{1}{8}$ " thick which is then attached to a copper or other disc base with an adhesive. It is then coated with a very thin layer of an electrically conducting metal, often gold. The disc is then placed into the instrument and bombarded with a stream of electrons. This induces the emission of a number of radiations including primary electrons rebounding off, secondary electrons from the metal in the sample, X-rays (and Auger electrons). Using the primary electrons, a highly magnified visual picture of the section may be obtained. Then running a narrow beam of electrons across the sample the wavelength and intensity of the X-rays given off varied with incidence and concentration of the various elements present. By adjusting the detector system to receive only a narrow wavelength band characteristic of a particular element, this element may be monitored across

the section.

Later use of the technique employed the secondary electrons given off. The energy of these electrons is also characteristic of the particular element bombarded and the detector system may again be adjusted to record the incidence of electrons within a narrow energy band.

The most well known example of the use of this technique in plant work was that of Lauchli (1967). Controversy existed over the exact mechanism whereby cations reached the xylem in the roots from the symplasm. Either the ions leaked out of the cells around the xylem or they were pumped out using a carrier. If the former, there would be a gradual decrease in concentration on approaching the xylem, if the latter, a relatively high concentration of the elements would occur in the cells abutting onto the xylem. Lauchli applied his technique to a section of plant root material and found a high concentration in these cells. Hence carrier transport appears to be the answer.

This example indicates the usefulness of this relatively new technique.

The elements so far examined by this method have tended to be macroelements with the use of X-rays. Microelements tend to be in too low concentration and require high energy electrons which tend to destroy the section. With plant material containing high concentrations of the microelements this technique may be applied.

This then is the general background theory, the work done and the techniques employed.

A number of plant samples from iron, copper and zinc sites were available for investigation and it was necessary

to survey these to find which plants from which sites had taken up the various metals into their tissues. This, together with a simple extraction scheme (see section 1.11, c) was performed on the plant samples and reported in chapter II.

Chapter III reports the attempts to identify some aqueous and ethanol soluble metal compounds using the techniques described in section 1.11, d. Chapter IV investigates the chemical identity of various insoluble metal compounds present and reports on the work done on identification of accumulation sites in the plants. Chapter V records a number of experiments broadly investigating the specificity and bonding in the accumulation sites.

CHAPTER II

General Analysis of Plant Material2.1 Metal concentration determination - introduction

The plant samples chosen for this initial survey were those available found growing on very highly mineralized soil. Some of them appear to have survived by managing to retain comparatively low levels of metals in their tissues. These species, after total metal analysis and routine extraction were discarded from further investigation. Others, though containing high concentrations of metal, were found impossible to germinate and replacement material difficult to obtain in large enough quantities, these were also discarded. The major plant samples examined initially were:-

1) Polycarpaea glabra

A low, bushy plant, maximum height about ten inches, it possesses large white sepals which remain on the plant long after the actual flowers have fallen. It possesses spine-like leaves and is found growing on areas of disturbed ground, particularly in lead/zinc rich areas, e.g. on and around metal workings. It also grows in copper rich sites though this is of lesser importance. The samples examined here were found in the lead/zinc rich site at the top of the Dugald River lode in North west Queensland.

2) Ecobolium lugardae

This species is found growing widely throughout Southern Africa. It normally constitutes the woody component

of the herb layer under low tree cover of Colophospermum mopane. It grows up to 2 feet high, has broad leaves, (unlike Polycarpaea glabra and Helichrysum leptolepis), and pale-blue flowers. It is often found growing on high copper soils. The samples examined here were from the copper rich areas at Messina in the Northern Transvaal.

3) Crotalaria nova hollandiae

This is a low, woody Australian perennial with bright yellow lupin-like flowers. It is very fast growing and is usually one of the first plants to appear after bush fires. It grows widely throughout Central Australia and Queensland with no obvious preference for any particular soil type, climate or metal rich sites. Samples used here were collected from the bottom of the Dugald River lode site.

4) Helichrysum leptolepis

This is a low (maximum height ten inches), bushy, woody plant, grey in colour due to a thick covering of fine hairs, and possessing characteristic off-white flowers. It is found growing, particularly on sandy soils, south of the Zambesi in areas of low rainfall. It is found widely in South west Africa, particularly in a band which spreads from the north west of Windhoek extending east into Botswana. It apparently favours unfavourable, bare areas due to lack of ability to compete with other plants. It is found growing in copper-rich areas, probably for the same reason.

The samples examined here were found growing on a copper rich site just to the north west of Windhoek.

The initial information required is, in which plant samples and plant parts the metals are accumulated? Samples of the plants were prepared for metal analysis on the atomic absorption spectrophotometer.

a) Method

The technique employed to obtain the metals in solution for analysis was that of wet ashing. The plant parts were first collected and washed (contamination by even small quantities of highly mineralized soil can give quite erroneous results). The plant parts, stems, leaves and flowers (if applicable) were dried for eight hours in an oven at 76°C and then ground in a Glen Creston agate ball mill. The ground material was bulked and stored in a desiccator over calcium chloride. Then, in duplicate, a certain mass of material was weighed in a 100 cm^3 conical flask, a known volume (normally either 10 cm^3 or 15 cm^3) of A.R. grade concentrated nitric acid was added and a short stemmed funnel inserted in the neck of the flask. This was then placed on a hot-plate and the temperature adjusted so that, after initial effervescence, the resulting solution was just below boiling point. This set-up was left for two days or until the solution was clear and colourless, whichever was the longer. The flask was then removed from the hot-plate, allowed to cool and the solution diluted to a suitable volume (normally 50 cm^3 or 100 cm^3). This solution was then analysed on the atomic absorption spectrophotometer (Shandon-Southern A3000). The readings were compared with a series of standards rather than by the method of standard additions because a number of elements were to be analysed.

In addition to the analysis of specimens from the field Ecbolium lugardae was grown from seed in soil taken from the college grounds and watered with distilled water. The pots were kept for about sixteen weeks before harvesting and the aerial parts again analysed as above. Polycarpaea synandra and Polycarpaea glabra were also grown from seed in John Innes Potting Compost number 1 and watered with 20 ppm zinc. After approximately twelve weeks these were also harvested and analysed. These were the only species for which seeds were available.

b) Results

The values of copper, iron, lead and zinc concentrations in dried sample material are given in table I.

c) Discussion

As noted in chapter I, readings of total metal concentrations in plant material are the resultants of a myriad of interacting factors and hence the information rendered by them is limited. However, one may identify which plant samples are the most heavily mineralized in their aerial parts and in which metals. In view of the fact that the majority of the samples seemed to have colonized the mineralized area and apparently thrived on the diminished competition, these plants must retain some degree of tolerance to disruption by the metal in high concentrations in their tissues.

There have been recorded a very large number of metal concentration interrelationships, for example, the copper : iron ratio in a large number of samples lie within

Table I Overall metal analysis of plant part samples

The readings are given on a dry weight basis and are in p.p.m. units (parts per million)

A hyphen represents a metal concentration in solution below the limit of detection.

Sample	Cu	Fe	Pb	Zn	Ca
Ecbolium lugardae (seed)	roots	1440	124	24	26,185
	stem	67	27	20	26,935
	branch	97	228	22	35,871
	leaf	20	168	37	30,185
Polycarpaea synandra (seed) bulked aerial matter	12	140	11	450	20,129
Polycarpaea glabra (seed) bulked aerial matter	8	110	31	600	19,125
Polycarpaea synandra	stem	410	30	110	
	leaf	500	90	115	
Polycarpaea glabra	stem (green)	65	60	484	
	stem (brown)	215	306	808	
	flowers	180	41	216	
Crotalaria nova hollandiae	stem	8	787	4747	
	leaf	6	760	8974	
Helichrysum leptolepis	stem	180	2305	240	
	leaf	222	2280	240	
	flower	264	2891	-	
Vaccinium myrtilis	stem (green)	-	53	-	
	stem (brown)	8	108	17	
	leaf	-	124	-	
Silene maritima	stem	4	120	231	
	leaf	8	120	359	
Ecbolium lugardae	stem	11	690	-	
	leaf	37	896	-	

relatively narrow limits. Although the results here also lie within these limits such mathematical exercises are not really instructive as mechanisms of intermetallic relationships in plants tend to be far more complex. In addition, for certain cases of tolerance it has been observed that change in the concentration of the metal in the tolerant plant has no effect on the level and distribution of other metals (Peterson (1969)). Comparing the figures given here with those of Cannon (1960) (which are values of a large number of analyses of plants growing in non-mineralized soils) and assuming a 95% weight loss in ashing.

Fe 337 ppm Zn 48 ppm Cu 9 ppm Pb 4 ppm

we can see that by far the most spectacular result is that of zinc in Crotalaria nova hollandiae which possesses two hundred times Cannon's figure. Polycarpaea glabra is the next most highly mineralized species in zinc with between only ten and twenty times the average figure. For copper and iron Helichrysum leptolepis is the most highly mineralized. In general, leaf material tends to possess higher concentration of metal than stem material. As expected calcium figures are a factor of about one hundred times larger than the other metal concentrations. This is typical of calcium concentrations in plants.

The results obtained for Ecboium lugardae samples grown from seed are curious. Most soils contain comparatively high concentrations of iron so that in analysis all plant parts, especially roots, must be washed very thoroughly to remove this source of contamination. Iron is also present in many objects and in dust in the laboratory so that

contamination is a serious danger. The connection between iron deficiency and chlorosis was undiscovered for many years due to failure to preclude iron contamination (Smith (1962)). Hence, every precaution was taken here in the analysis of the plants. It was surprising, therefore, that the Ecbolium roots possessed a remarkably high iron value not found in other plant parts. As iron cations cannot exist in a solution of pH greater than five and must therefore be complexed before it can travel in the xylem, competition for the ligand by other metals will render the iron immobile, resulting in accumulation in the roots.

Lead was also found at unexpected levels in the plant. As no lead was given to Ecbolium in its water the metal must have been present in the soil. This was collected from the college grounds and it is assumed that most of the lead was derived from car exhausts from the adjacent car park. Curiously, the metal itself appeared to accumulate in the branches leading from the main stem, and the stem itself, and indeed the roots, were at a considerably lower level of lead mineralization (for a review of Pb in plants see Hoover (1972)).

2.2 Extractions - introduction

From the readings given in section 2.1 (b) table I it can be seen that Polycarpaea glabra and Crotalaria nova hollandiae possess relatively high levels of zinc in their tissues, Helichrysum leptolepis and Polycarpaea synandra, high copper, Helichrysum (again) and Ecbolium lugardae high levels of iron and the two Polycarpaea species elevated levels of lead. Hence these five species were further

examined (i.e. Polycarpaea glabra, Polycarpaea synandra, Crotalaria nova hollandiae, Helichrysum leptolepis and Echolium lugardae).

The concentration figures given represent the total concentration of metal in the tissues, it says nothing of the type of metal compounds and the bonding of the metals present. In order to derive some information in this direction a simple extraction scheme was devised based on a series of common solvents of increasing dipole moment.

a) Method

The extraction scheme devised (see section 1.11 (c)) was that shown in Fig. XIII.

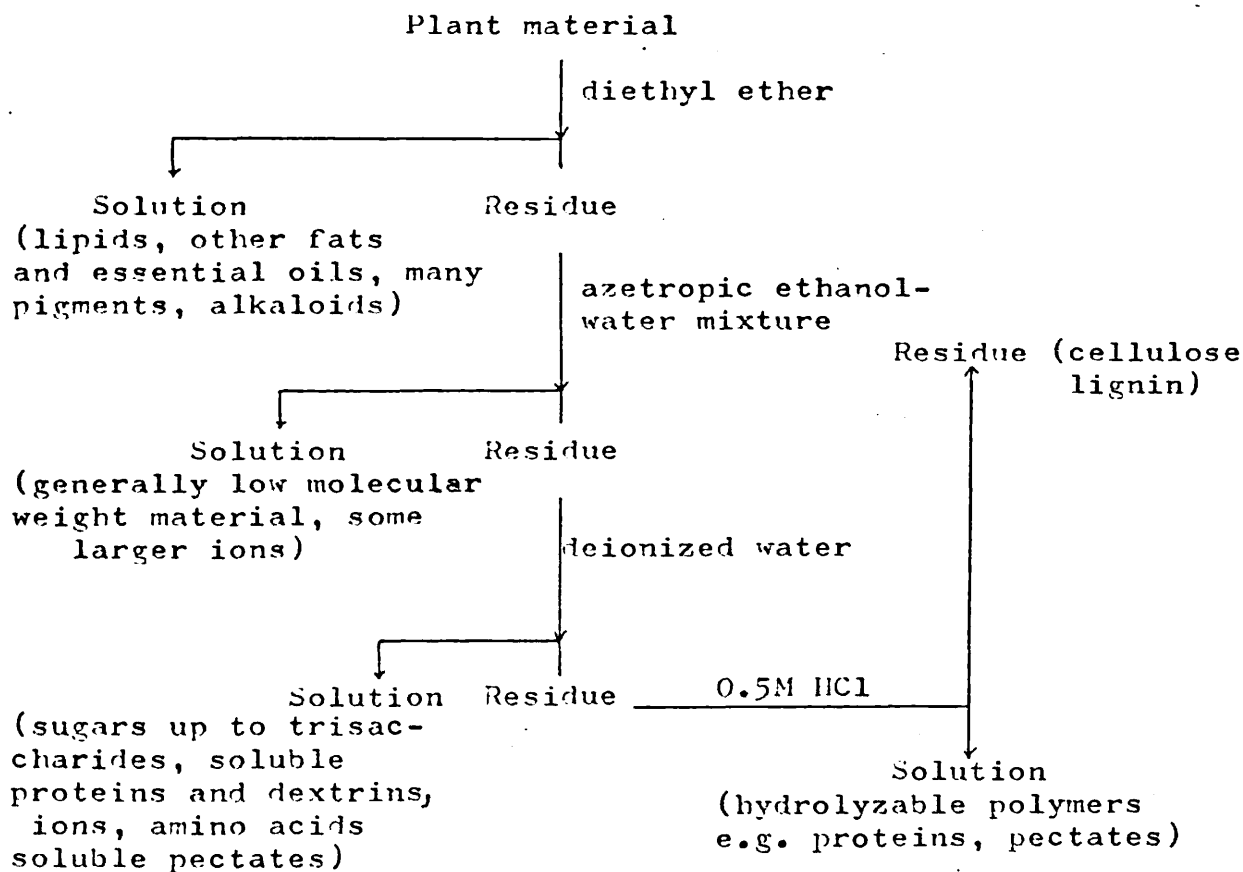

Fig. XIII General extraction scheme for chemical characterization of metals present in plant material

This scheme is not considered as a rigid analysis but rather an indication of chemical character of the compounds with which the metal is associated. In duplicate the washed, dried and ground plant material was weighed out into a soxhlet thimble. The apparatus was then set up with a third set containing an empty thimble as blank, even though the best grade solvents were used. Samples were left syphoning for twenty-four hours. Then the 250 cm³ round bottomed flask in the heating mantle was replaced with an identical flask containing 150 cm³ of the next solvent.

As dilute acid cannot be refluxed a different procedure had to be adopted for this solvent. After aqueous extraction the thimble was dried at 90°C and weighed. The plug of plant material was then carefully removed from the thimble and placed into a weighed 250 cm³ conical flask. The final mass was determined and knowing the mass of the dried thimble, the loss in mass in the transfer of the material could be calculated. 150 cm³ 0.5M hydrochloric acid was added to the flask which was then shaken for twenty-four hours. The mixture was allowed to settle and the clear solution drawn off. The residue was wet ashed in the normal manner (see section 2.1 (a)).

Each of the solutions after extraction were evaporated to near dryness using a rotary evaporator and 10 cm³ A.R. concentrated nitric acid added to the flask. The flasks were supported on sand trays on a hot-plate and heated for about forty-eight hours when the solutions were seen to be colourless. They were all made up to known volume in volumetric flasks and read on the atomic absorption spectrophotometer. The concentrations of the metals in the

dried plant material extracted with the respective solvents were then calculated.

b) Results

The averaged results obtained from the plants examined for the various chemical categories are shown in table II. The total metal concentration values are included for comparison.

In general the sum of the various extracted concentrations of metals is in agreement with the wet ashing value though agreement with iron in Helichrysum leptolepis is poor (see section 2.2 (c)), as is the case of zinc in Polycarpaea synandra leaves.

The main causes of difference are contamination in the laboratory, particularly for iron, impurities in the acid solvent, again particularly for iron and the fact that atomic absorption as a technique has a limited accuracy. Summation of these factors would account for any differences except in the three cases mentioned (for explanation see the section 2.2 (c)).

c) Discussion

Polycarpaea glabra

For this species the leaves are merely insubstantial spines of unexceptional metal concentrations so that the plant parts examined are general stem material, green stem material and flowers.

It may be seen from the figures obtained that green stem material is far less highly mineralized than other stem material. For zinc, general stem material possesses

Table II Extraction: average metal values (ppm)

	Diethyl ether (non-polar compounds)	Aqueous ethanol (low molecular weight compounds)	Water (remainder low molecular weight compounds)	Dilute acid (hydrolyzable polymers e.g. protein, pectin)	Wet ashing residue (α -cellulose lignin)	Sum	Total wet ashing
<u><i>Polycarpona elabra</i></u>							
Zn	24	53	131	306	10	523	484
	27	91	396	289	43	846	795
	11	76	40	76	8	211	216
Fe	19	10	5	10	29	73	65
	-	5	3	32	86	126	122
	-	-	-	92	58	150	180
Pb	-	-	-	29	73	102	60
	32	32	21	64	47	164	192
	-	-	-	32	-	32	41
<u><i>Leboulia lugardae</i></u>							
Fe	-	-	-	502	163	665	610
	-	-	-	637	203	840	896
Cu	-	-	5	5	-	10	11
	-	-	12	31	-	43	37
<u><i>Crotalaria nova hollandiae</i></u>							
Fe	50	50	85	361	241	787	787
	60	50	75	385	198	768	760
Zn	-	2	2921	1438	494	4855	4747
	69	275	6534	2410	121	9409	8974
<u><i>Helichrysum leptolepis</i></u>							
Fe	-	-	159	2199	709	3067	2305
	-	-	57	1372	419	1848	2280
Zn	8	16	100	129	5	258	240
	11	18	120	120	-	269	240
Cu	-	-	58	111	29	198	180
	-	-	53	168	8	229	222
<u><i>Polycarpona synandra</i></u>							
Fe	-	-	21	254	106	381	410
	-	-	43	434	62	539	509
Zn	-	-	80	42	5	127	110
	-	-	156	58	-	214	115
Cu	-	-	36	152	-	188	185
	-	-	34	21	-	55	60

approximately 60% more zinc than green stem material and most of this excess can be seen to be present as a comparatively low molecular weight material soluble in the aqueous fraction. The other solvents extract approximately the same concentrations of zinc from the two stem samples. The inference is that as the plant ages, more and more zinc is deposited in the woody stem as a water soluble compound and thus maintaining the zinc concentrations of other components more or less constant. For young plant material where this woody metal accumulation site has not developed approximately 60% of the zinc is present in association with the insoluble protein-pectate fraction. In other stem material this is, not surprisingly, down to 30%.

Flower material of Polycarpaea glabra can be seen to be the least mineralized plant part for lead and zinc. For zinc it possessed only half the metal concentration of green stem which itself possesses only 60% of that of all stem material. Glabra flower material is also unusual amongst the plants and plant parts examined in that over one third of the total zinc present was soluble in aqueous ethanol. This is a very high figure in comparison with other samples; for green stem this figure is only one tenth and for general stem material, approximately one ninth. This aqueous ethanol soluble zinc compound is further investigated, the original plant sample was, of course, found growing on zinc rich soils.

Iron is slightly unusual in the stem of this plant because so little is soluble in the dilute acid. Almost three times as much is found insoluble in acid. For the flowers however, the more usual condition occurs where the majority of iron is present in the acid soluble fraction.

Approximately one quarter of the iron present in green stem is a non-polar compound which does not appear to be present in very appreciable concentrations in the stems and flowers. The total iron level is very low indeed.

Lead is often found in the presence of zinc in the soil and the Dugald River area, where Polycarpaea glabra is harvested, is no exception. However, the metal was taken up by the plant in relatively low concentrations. For stem material a very high proportion of the metal present was insoluble in all the solvents used. In the flowers all the lead was soluble in dilute acid.

Ecbolium lugardae

This species was found growing on a relatively high concentration copper site but, as may be seen (table I), very little copper appears to have entered the plant. Although apparently contradicting the Bradshaw rule (1965) (that plants possess no mechanism for keeping specific heavy metals from their tissues), there are, of course, a number of possible explanations of the phenomenon (see section 1.6). For example, the species itself may possess a low uptake rate, the metal may be present in the soil as an insoluble compound or the roots which are very superficial may not reach the copper deposits (or solutions).

As found in other species the vast majority of the iron present in the plant is found in the acid soluble fraction, 85% in stem material and 75% in leaves. The only real exception to this rule occurred in the Polycarpaea glabra plant, as mentioned in the previous section, where comparatively large concentrations were found in the aqueous ethanol

factions.

The remainder of the iron, again typically, is left undissolved in the cellulose-lignin fraction. Iron is an essential element required at somewhat higher concentrations than other micronutrients. However, at the pH of the interior of the xylem vessels (approximately 7.8) iron is hydrolysed and precipitates out of solution. Hence, if iron was present as ions, transport of the metal in the transpirational flow would be impossible. It has been noted (section 1.10) that Tiffin (1967) found iron present mainly as the citrate anion in the xylem and is therefore soluble and mobile. However, for Ecbolium lugardae no water soluble iron could be detected. Now, although the overwhelming majority of the iron in plant tissue enters via the roots and is transported in the xylem, the concentration of the metal in this anion at any one time is very low and is not detected.

As the concentration of copper in this plant was found to be very low and no seeds for the sample were available, little further work was performed with this species.

Helichrysum leptolepis

As noted previously in section 2.1.3, Helichrysum leptolepis is covered with a fine covering of intertwined hairs. This made grinding difficult (before the purchase of the Glen Creston ball mill) and enormously enhanced the probability of iron soil contamination. As a result the sum of the concentrations of metals extracted and the total concentration of metal did not correlate well in the case of iron. It is possible that the concentration of iron in

Helichrysum leptolepis leaves varies considerably but that of copper remains relatively constant. In any event the figures for iron must be considered a rough guide only. Here again, however, most of the iron was present as an acid soluble compound and relatively little was present in a form soluble in water.

The copper levels of extracted metal correlated well with these of total copper present and were high for this metal. The majority of this, though not such an overwhelming majority as with iron, was present in the acid soluble fraction. A far higher percentage of copper was extracted with water than was iron.

The concentration of zinc soluble in water and dilute acid was approximately the same.

Polycarpaea synandra

For this species none of the metals tested was extractable in ether or ethanol. The majority of the iron was again present in the acid soluble fraction but the relative level of iron was low. For zinc, leaf material gave inconsistent results, probably due to contamination in one of the extractions, and lack of further material prevented repeat analyses taking place. However, it appears that Polycarpaea synandra has a high proportion of water extractable zinc compounds. Comparatively little zinc was present in the acid soluble fraction and insoluble residue.

For stem material approximately 85% of copper was extractable in dilute acid whereas for leaf material this figure dropped to around 35%. The copper level in stem material was, in fact, relatively high and the excess over

the leaf value was all found in the acid soluble fraction, the concentrations soluble in other solvents being more or less identical.

Copper and zinc occur together at this site and this is reflected in the high levels of these metals in the plant material.

Crotalaria nova hollandiae

There is over 85% more zinc in a given mass of leaf material than in the same mass of stem material. Crotalaria leaves from this Dugald River site possess exceedingly high concentrations of zinc.

A far greater concentration of zinc in leaves is soluble in ethanol and water than zinc in stems. However, over four times as much zinc in stem is insoluble in all solvents than zinc in leaves. Figures for summation of the extracts and wet ashing correlate well.

Iron is relatively low in concentration in all the aerial parts of the plant, but again, the majority is soluble in dilute acid solutions. In all the plant species examined (except Polycarphaea glabra stems) this was the case and it contrasts markedly with the bonding of zinc in the plants.

Copper in this species was surprisingly low in concentration.

d) Conclusion

The major points arising from this survey of the available plants from highly mineralized soil are:-

1. Crotalaria nova hollandiae possesses extraordinarily high levels of zinc, particularly in the leaves.

2. The majority of this is water soluble.
3. Polycarpaea glabra also has high zinc levels but these are much below those of Crotalaria.
4. For general stem material of Polycarpaea glabra the largest zinc fraction is again the water soluble one, but in specifically green stem most of the zinc is insoluble in water but soluble in dilute acid. (Both these species derive from the same area).
5. Helichrysum leptolepis possesses high levels of copper and iron.
6. Ecbolium lugardae exhibits an unusual treatment of lead.
7. The majority of iron present in the plants (except Polycarpaea glabra stem) is present as an acid soluble compound.

Thus Crotalaria nova hollandiae possesses high concentrations of zinc in its aerial tissues, the majority of which is water soluble. In addition, approximately one half of all the zinc present in Polycarpaea glabra stem material is water soluble and the biggest single zinc fraction in Polycarpaea glabra flowers is soluble in aqueous ethanol.

In the next chapter these three zinc compounds are further examined together with the water soluble copper complex of Helichrysum leptolepis.

Chapter III

Investigation of Some of the Soluble Metal Compounds Present in Particular Plant Species

3.1 Background

It was noted in section 1.10 that comparatively few soluble metal complexes from plants had been identified, and most of the important work done was listed in that section. The general method of investigation and identification in all the work reported involves extraction of the fresh plant material with water or aqueous ethanol (unless the sample is an exudate), separation normally on a chromatography column, frequently using gel filtration, and examination using chromatography and/or electrophoresis techniques. Finally, in the cases where an identification could be made the compound was synthesised and compared with the sample compound as regards mobility to confirm the identification.

In all the steps described physical and chemical changes may occur which interfere with results and may lead to incorrect conclusions. For example, a living cell growing normally is a very highly-ordered, complex structure. It is divided into numerous compartments by cell membranes through which metal ions and metal complex ions cannot permeate (but may be carried across by active transport). Heavy metals may be very weakly complexed and easily dissociated, adsorbed as ions or complexes onto internal structures or concentrated in one small part of the cell, e.g. in ribosomes. Other cells within the same plant may have a very different arrangement of heavy metals. The

whole cell may have a delicate but highly complex ionic strength relationship and active pH stabilization. These relationships and ionic concentrations may vary with age and history, with plant part and function. In practice millions of these cells in different stages of development, with profoundly different structures and functions, possessing a myriad of different ligands, are ruptured, crushed and ground into a multicomponent 'soup' where any number of reaction may take place. Metals and ligands which may never come into contact with each other in the living cell are free to do so in the crushed extracted material. Mills (1956) has shown for example that ligands in plant aqueous extract combine with added heavy metal ions. In addition, water and ethanol, which would be in high concentration, may act as ligands themselves and replace the natural ligands in labile complexes.

Other problems that arise when the cell is punctured are described by Allfrey (1965). Hence, only a broad picture of the major stable metal complexes may be obtained.

Thus, the initial steps of grinding and extracting can profoundly affect the complexes originally present in the cell, particularly if they are labile. In addition, separation and purification methods may also give rise to problems in interpretation of results. Many types of column dissociate weak complexes, particularly if the rate of dissociation (rather than pK) is high. Ion exchange columns in particular, but also alumina, silica and others have a tendency to dissociate complexes. The mildest column for this type of separation is the Sephadex series which also gives added information of general molecular size. In these

columns the smaller molecular weight material is retained whereas the larger molecules tend to flow through with the solvent. Here again however, if the dissociation is fast, as the complex flows down the column the metal itself will tend to be retained and further fast dissociation will occur in order to increase the ion concentrations and retain equilibrium.



If $[M^+]$ decreases during the descent of the complex, further dissociation must occur to make the ion ratio constant.

Often the extract obtained or the eluant collected at the bottom of the column is too dilute to put through a second column or to run on thin layer chromatography, paper chromatography or electrophoresis. It must be concentrated using the rotary evaporator. Here again for many complexes dissociation or reaction may occur if the temperature is too high or too little solvent is present. Desalting of the solution for chromatography also greatly promotes dissociation of complexes.

Finally dissociation may well occur on the chromatography or electrophoresis paper due to the adsorption of the complex to the paper and the opposing factors of solvent reaction and solvent flow in chromatography, and buffer reaction and potential difference in electrophoresis. Many complexes dissociate at even relatively high pH's.

Hence the general procedure cannot be used to find very weak complexes, complexes with very fast ionization rates (kinetically labile) or complexes which react in the solvents

used. Discovery of uncomplexed metals on chromatography and electrophoresis paper should not lead to the automatic conclusion that the uncomplexed metal is present in the plant material. This is particularly true in the case of zinc, which is a weak complexing ion in comparison with iron.

In view of the general lack of information as to the identity of the chemical form of metals in plant parts, some of the more mineralized plants were examined for metal complex identification. It was observed in the extraction scheme described in the previous chapter that complexes of relatively low molecular weight were extracted in the aqueous and ethanolic solvents and that polymeric complexes generally remained insoluble and hence it is with the soluble complexes that we are primarily concerned in this section.

For zinc, the most highly mineralized plants available were Polycarpaea glabra and Crotalaria nova hollandiae (and for copper and iron they were Polycarpaea synandra and Helichrysum leptolepis).

An obvious 'candidate' for investigation is the ethanol soluble zinc complex of glabra flowers which contained such a high proportion of total zinc in flowers. The glabra stem extract was also examined for comparison. These were the only ethanol soluble complexes in high enough concentrations for examination. The water soluble zinc complexes of Polycarpaea glabra and Crotalaria nova hollandiae stems were also examined. For copper and iron water soluble complexes, the stems of Helichrysum leptolepis were extracted.

3.2 General Methods

The procedure involved was broadly as described above. Flower, stem or leaf material was ground in a Glen Creston ball mill. Approximately 3g of this material was shaken for about 12 hours with 150 cm³ of deionized water (or 80% ethanol). The resulting mixture was centrifuged at 2000 r.p.m. for 5 hours and the solution decanted off. The material was re-extracted and centrifuged and the solution added to the original extract. This was then evaporated to about 1 cm³ using the rotary evaporator or rotary pump. The actual weights (g) used and the final volumes obtained depended on the metals examined, the concentration of the metal in the particular solvent and the sensitivity of the locating reagent. These sensitivities decreased from zinc to iron to copper, and hence a comparatively high concentration of the copper was required.

Purification was achieved by a number of methods with varying degrees of success. Initially the concentrated solutions were spread along the origins of paper chromatograms and run off the end of the paper, the solvent containing the complex being collected. This technique, though effective was marred by two factors; firstly the procedure was often a very lengthy process (for the zinc complex in the aqueous extract of glabra stems, the time taken to reach the end of the paper was one week), secondly a proteinaceous compound with the same R_f value in butanol/acetic acid/water (12/3/10 upper layer taken) led to the conclusion that zinc was present in a soluble protein. This was later found not to be the case. Sephadex columns were also used and found to be satisfactory, little dissociation occurred.

Finally, and in conjunction with Sephadex columns, a desalter was employed to remove remaining ions present in the extract. It is important to remove these ions as their presence in all but very low concentrations effects the shape and R_f values of the spots. For the first two methods of purification evaporation was generally required to reconcentrate the complexes.

The paper chromatography was performed in the usual manner using 30 cm square paper, a horizontal line 2 cm up from the base of the paper was drawn in pencil and crosses inserted 3 cm apart along the line. The purified test solutions were applied using drawn out melting point tubes and the solutions dried with a fan drier. The papers, 5 to a frame, were inserted, after equilibration, into the solvent, which was about 0.5 cm deep, the whole frame being inserted into the tank, which was covered with a glass lid. The chromatogram was left until the solvent front had risen at least 15 - 20 cm. The rate, of course, varied with solvent and type of paper. The papers were removed, dried with a fan drier, sprayed with the appropriate indicator (see appendix) and examined. Descending chromatography was also used in appropriate cases.

For electrophoresis a Shandon Southern low voltage electrophoresis apparatus and tank were employed with Whatman Number 1 paper used throughout. The solvents, column material paper, pH and current were chosen with great care after much experimentation. The exact electrophoretic and chromatographic conditions used are described under the plant sample examined.

3.3 Zinc

a) Method

Polycarpaea glabra, Crotalaria nova hollandiae and Helichrysum leptolepis were examined for soluble zinc compounds. The ethanol extract of Polycarpaea glabra flowers, the aqueous extract of Polycarpaea glabra stems and Helichrysum leptolepis stem were prepared, purified by the descending paper chromatography method and the samples spotted on to Whatmann 3MM paper. Compared with copper and iron, zinc complexes are relatively unstable so that a whole series of solvents were attempted before the butanol/ acetic acid/ water system was found to produce the least degree of dissociation and the greatest differences between R_f values of the complexed and uncomplexed metal ion.

The samples, together with zinc ions, were spotted on the paper, dried and developed with butanol/acetic acid/ water present in the ratio 12/3/5 by volume. After drying, the chromatogram was sprayed with dithizone in chloroform to locate the zinc.

b) Results

The resulting chromatogram is shown in C1. The large spot from the zinc ion can be seen at an R_f value of about 35. The zinc in the ethanolic extract of glabra flowers was plainly present as a complex, as was the aqueous extracts of Helichrysum leptolepis stem. The complexes were close to the origin, however, and no R_f value could be taken. To increase the mobility, the water in the solvent mixture was increased until immiscibility occurred

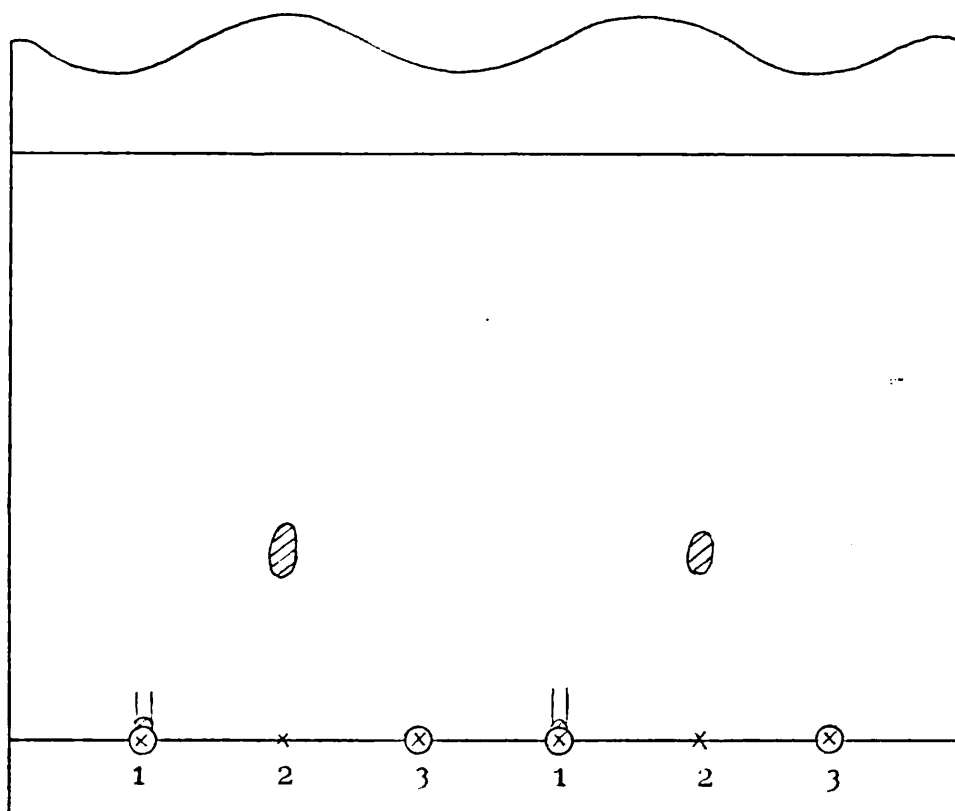
Paper Chromatography

Chromatogram C1 - Ethanolic extract of Polycarpaea glabra

flowers and aqueous extract of Helichrysum leptolepis stem. Half scale.

Solvent Butanol/acetic acid/water 12/3/5 by volume.

Indicator Dithizone

Paper Whatman 3MM

1. Polycarpaea glabra flowers, ethanolic extract
2. Zinc ions
3. Helichrysum leptolepis stem, aqueous extract

R_f Zn \sim 35

R_f Polycarpaea glabra stem $<$ 5

and the bulk upper layer used. The resulting chromatogram is given in C2 where the R_f value of the flower complex was found to be 14 and the Polycarpaea glabra stem complex not greater than 2.

The three extracts were then put through a Sephadex column (S-52) and rechromatographed. The resulting chromatogram is given in C2 giving R_f values of glabra stem and flower extracts of 10 and 23.

Hence there appear to be two distinct zinc complexes in the Polycarpaea glabra plant sample. To confirm that this is the case and that the different R_f values are not merely the result of physical retardation at the origin, the flower complex was taken up in water and the two aqueous solutions of complexes mixed together. The resulting solution was run on a chromatogram with separate flower and stem complexes and zinc. The paper was Whatman number 1, the solvent butanol/acetic acid/water (12/3/10 by volume, upper layer taken) and the indicator was dithizone in chloroform. The result was chromatogram C3. Two distinct spots can be seen for the mixture confirming two distinct complexes. The flower complex in the mixture appeared fainter and the stem complex stronger, suggesting some conversion from one complex to the other.

Finally another confirmatory experiment was performed to ensure that two separate complexes existed. The two samples were spotted onto Whatman 3MM paper, 90 cm long and run with the same solvent in the descending method. If different R_f values were caused by differential retardation at the origin, the R_f values obtained for the samples after a prolonged run should be higher than those already obtained

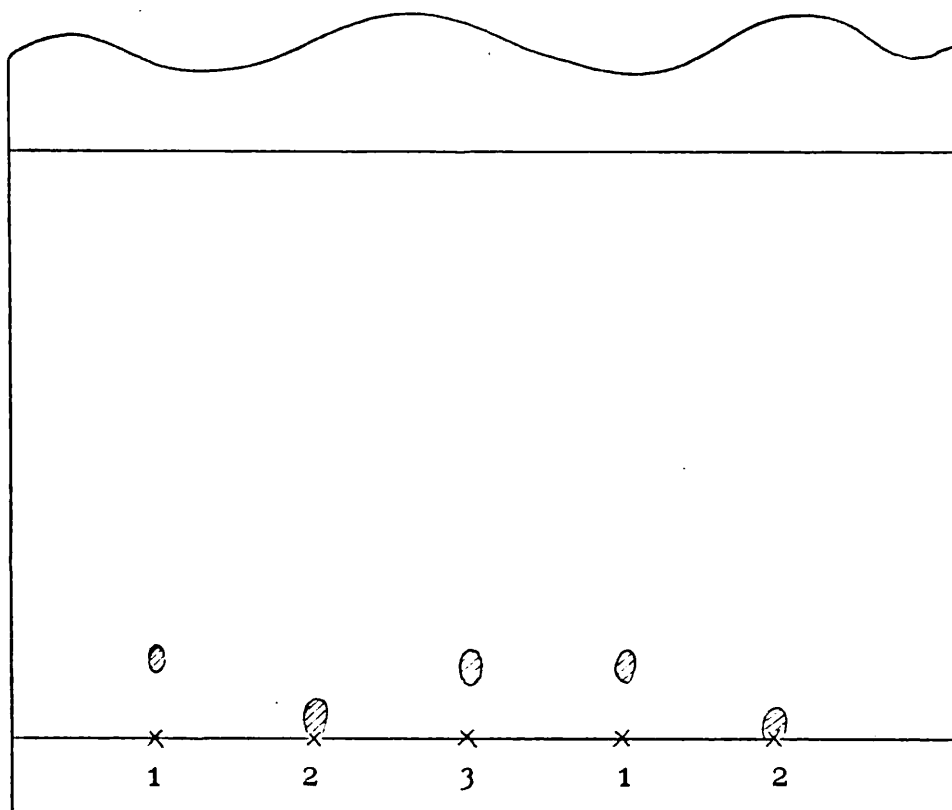
Paper Chromatography

Chromatogram C2 - Purified ethanolic extract of Polycarpaea glabra flowers and aqueous extract of Polycarpaea glabra stems. Half scale.

Solvent Butanol/pyridine/water 12/3/10 by volume

Indicator Dithizone

Paper Whatman 3MM

R_f Polycarpaea glabra stem < 2

R_f Polycarpaea glabra flower ~ 14

- 1) Polycarpaea glabra flowers, ethanolic extract
- 2) Polycarpaea glabra stems, aqueous extract
- 3) Helichrysum leptolepis stem, aqueous extract

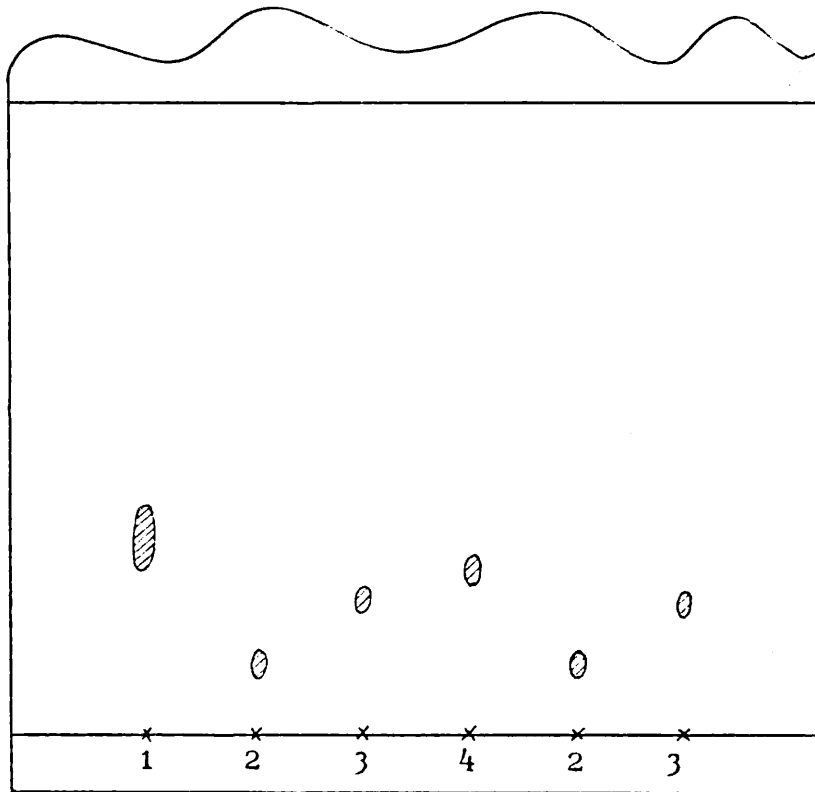
Paper Chromatography

Chromatogram C3 - Ethanolic extract of Polycarpaea glabra flowers and aqueous extract of Polycarpaea glabra stem. Half scale.

Solvent Butanol/acetic acid/water 12/3/10

Indicator Dithizone

Paper whatman 3MM

R_f Polycarpaea glabra stem material ~ 10

R_f Polycarpaea glabra flower material ~ 23

- 1) Zinc ions
- 2) Polycarpaea glabra stem, aqueous extract
- 3) Polycarpaea glabra flowers, ethanolic extract
- 4) Helichrysum leptolepis stem, aqueous extract

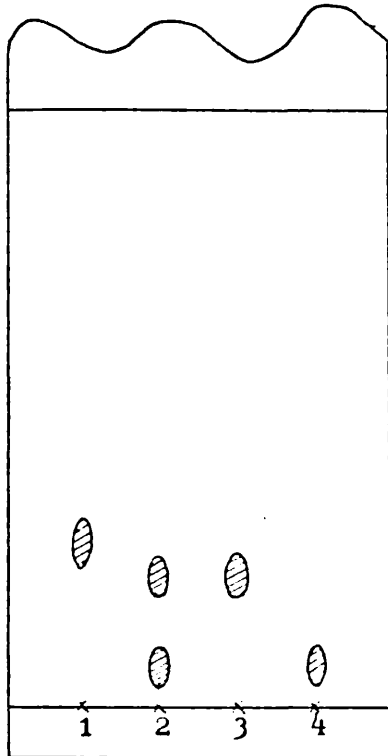
Paper Chromatography

Chromatogram C4 - Polycarpaea glabra
flower and flower/
stem mixture

Solvent As chromatogram 3

Indicator As chromatogram 3

Paper Whatman No. 1

1. Zinc
2. Stem/flower mixture
3. Flower complex
4. Stem complex

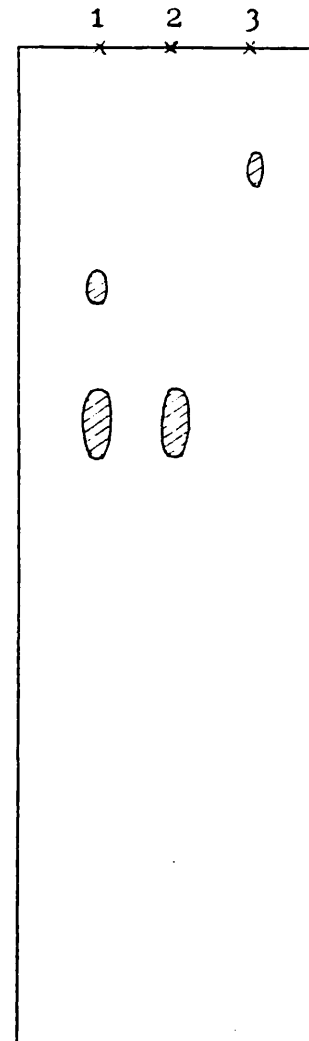

Chromatogram C5 - samples and
conditions
identical with
chromatogram 3.

Descending
technique

1. Polycarpaea glabra flower
complex
2. Zinc
3. Polycarpaea glabra stem
complex

and should also be closer together in value. Chromatogram C4 shows a scale diagram of the chromatogram obtained showing widely separated spots and the R_f values are similar to those already obtained (23 and 10). The ethanolic extract showed a large degree of dissociation. Finally the aqueous extracts of flowers and the ethanolic extracts of the stem were chromatographed and found to possess the same R_f values as the zinc compounds in the two previous extracts.

Hence it may be said with some confidence two different and distinct zinc complexes have been extracted from Polycarpaea glabra.

3.4 Determination of the Charge and Mobility of the Complexes by Electrophoresis

a) Method

The two complexes were spotted onto Whatman Number 1 paper (10 cm wide, 30 cm long). The buffer used was a pyridine acetic acid pH 6.9 system and the potential difference 340 V (17 V cm^{-1}). The apparatus was left for 25 minutes when the paper was removed, dried and sprayed with dithizone.

b) Results

The resulting electrophoretograms are drawn in diagrams E1 and E2. The stem complex can be seen to have moved towards the negative electrode and at a rate of about half that of zinc ions. From diagram E2 it can be seen that the ethanol complex is absolutely immobile. Electrophoresis of this complex was repeated at a pH of 7.9, with the same result.

Electrophoresis Paper	Whatman Number 1
Locating reagent	Dithizone
Buffer	Pyridine/acetic acid pH 6.9
Potential	17 volts cm^{-1}

E1 Zinc and Polycarpaea glabra stem aqueous extract.

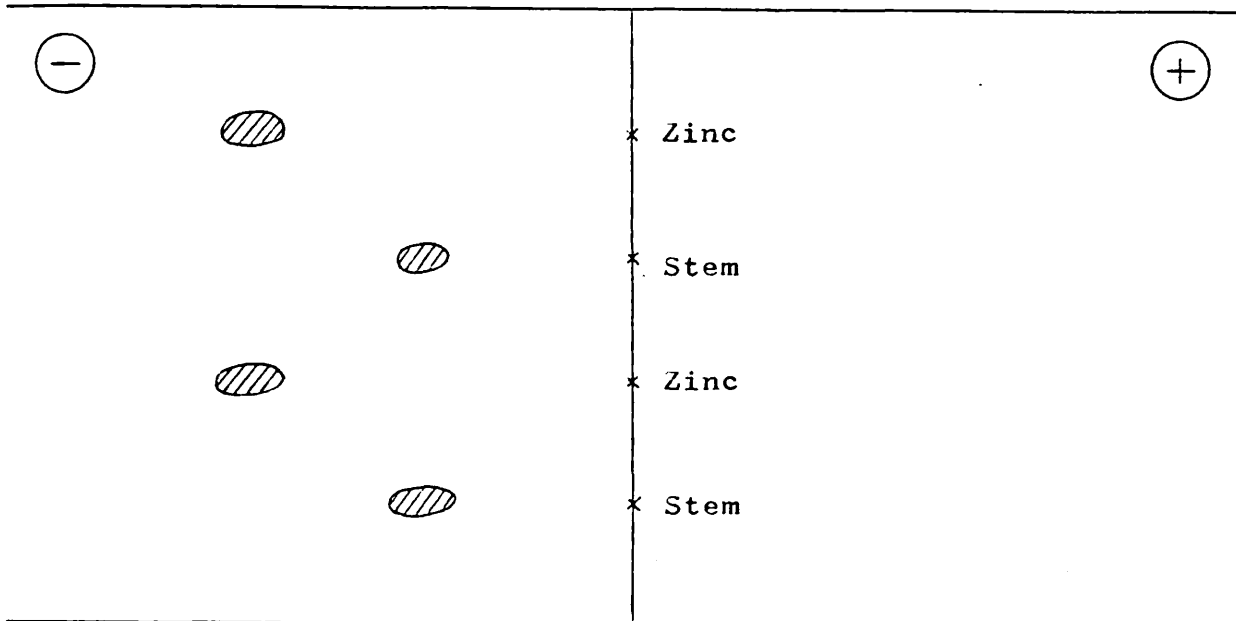

E2 Zinc ions, Polycarpaea glabra stem (aqueous extract), Polycarpaea glabra flowers (ethanolic extract), Helichrysum leptolepis stem (aqueous extract).

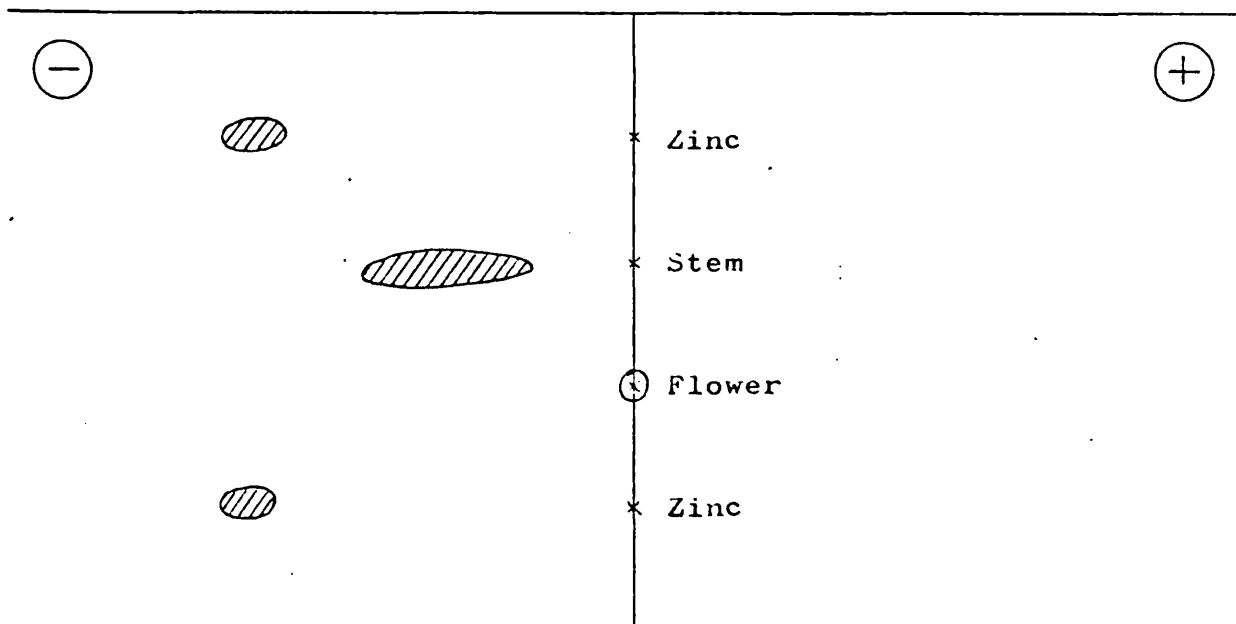

c) Conclusions

For Polycarpaea glabra flower material the dominant zinc species in flowers is an uncharged complex of relatively low molecular weight (withheld on a Sephadex S-52 column), relatively unstable (dissociates in many chromatographic solvents) and soluble in aqueous ethanol. The dominant zinc containing species in stem material was found to be a fairly stable complex of generally low molecular weight, soluble in water and apparently positively charged (though dissociation to zinc ions may be responsible for the electrophoretograms obtained). Zinc ions do not appear to be present in Polycarpaea glabra in any appreciable quantities.

That the ethanolic extract of flowers possesses a relatively unstable zinc complex is clear from a number of sources. When the two complexes were mixed together the ethanolic complex appeared to be converted to the aqueous complex (or rather the ethanolic complex dissociated, the zinc combining with the ligand of the aqueous complex). In the long descending chromatogram the flower complex gave two spots, one with the original R_f value of the flower complex and the other with the R_f value of Zn^{2+} ions.

When the deionizer was used on the sample solutions to remove ions and improve the chromatograms, both complexes dissociated.

3.5 Investigation of the Ligands of the Two Complexes Extracted from Polycarpaea glabra

The work of the botanists reviewed in section 1.10 involved almost exclusive use of chromatography and electrophoresis (except Timberlake (1959) who used

potentiometric titrimetry). Ideally, from a chemical point of view, the complexes should be isolated and purified and elemental analysis, u.v., i.r., n.m.r. and crystallographic techniques applied to the problem of identification.

Unfortunately, kilogram quantities of plant material would be required together with the ability to obtain the complex unchanged in a high state of purity. Thus, here again, the two original techniques are employed.

The aqueous extract of Polycarpaea glabra stem material was considered first. A variety of solvent systems, papers and plates were used to study the complex, the great majority of which caused the complex to dissociate (see also section 3.3 a)). The only systems, however, found acceptable were Whatman 3MM and 1 papers with butanol/acetic acid/water (12/3/5 and /10, by volume) for paper chromatography and the equivalent cellulose plates with the same solvents for thin layer chromatography. Even with these systems very prolonged running resulted in dissociation as did any attempt to isolate the complex using a cellulose column.

The problem of finding a system for the complex centres on the fact that the complex adsorbs very strongly on most substrates. Hence the least polar substrates are selected and the most polar solvents, this should increase mobility. Unfortunately, it also causes dissociation, for example, methanol and water causes streaking to occur. The butanol system used gives rather low mobilities but attempts to increase this in thin layer chromatography results in elongation of spots.

An attempt to further separate the complex by scraping off the cellulose in the area of the zinc complex from the

developed plate and eluting resulted in complete dissociation. Dissociation also occurred using silica gel and other plates.

a) Method

The aqueous extract of Polycarpaea glabra stem was prepared as described and put through a Sephadex 25 column. The eluant was spotted onto filter paper impregnated with dithizone. The complex was intermediate in mobility emerging, helpfully, between two coloured bands. This indicates a molecular weight of under 1000 for the complex. The solution emerging at the end of the column did not need to be concentrated before spotting onto chromatography paper or thin layer chromatography plates. This solution could be stored for a long period without deterioration. However, if the solution was not put through the Sephadex column, dissociation of the complex occurred, probably by competition for the ligand by other metals. Gel filtration removes many of the competing ions from the zinc complex solution.

The solution of the separated complex was spotted firstly onto thin layer chromatography plates and the chromatograms were developed using butanol/acetic acid/water (12/3/5, by volume) and subsequently onto silica gel plates treated with 0.1M boric acid, developed with benzene/acetic acid/methanol (1/1/3, by volume) and sprayed with orthophosphoric acid-aminobiphenyl reagent. Finally, silica gel plates were employed with methyl ethyl ketone/acetic acid/methanol (3/1/1, by volume) as developing agent and anisidine phthalic acid as identification reagent.

b) Results

The chromatogram resulting from development of cellulose plates with butanol/acetic acid/water (12/3/5, by volume) and spraying with dithizone is shown in TLC1. The zinc spot in particular is far less elongated than in paper chromatography but the difference in R_f values of the complex and zinc ions is not as great; R_f complex = 11, R_f zinc ions = 21.

Spraying the developed chromatogram with ninhydrin gave no colour even after prolonged hydrolysis of the complex - hence it is not an amino acid, peptide, polypeptide or protein complex. Spraying of chromatograms for acids, phenols and others showed no positive reaction. However, the dissociated complex on silica gel plates gave a clear yellow-brown spot on spraying with orthophosphoric acid-aminobiphenyl indicating the presence of a carbohydrate.

The complex was hydrolysed for half an hour with dilute hydrochloric acid and run on silica gel plates treated with 0.1M boric acid, developed with benzene/acetic acid/methanol (1/1/3, by volume) (Pastuska (1961)) and sprayed with orthophosphoric acid-aminodiphenyl reagent. The carbohydrate spot could be seen at an R_f value of approximately 35 (TLC2). In the literature, e.g. Zweig and Sherma (1972), only D-galacturonic acid has an R_f value close to this, and no other carbohydrate has an R_f value with this system of less than 50. In another chromatogram identical to the system just described, the plate was sprayed with anisidine-phthalic acid, which gave a variety of colours for carbohydrates. The distinct brown colour indicating uronic acids was observed.

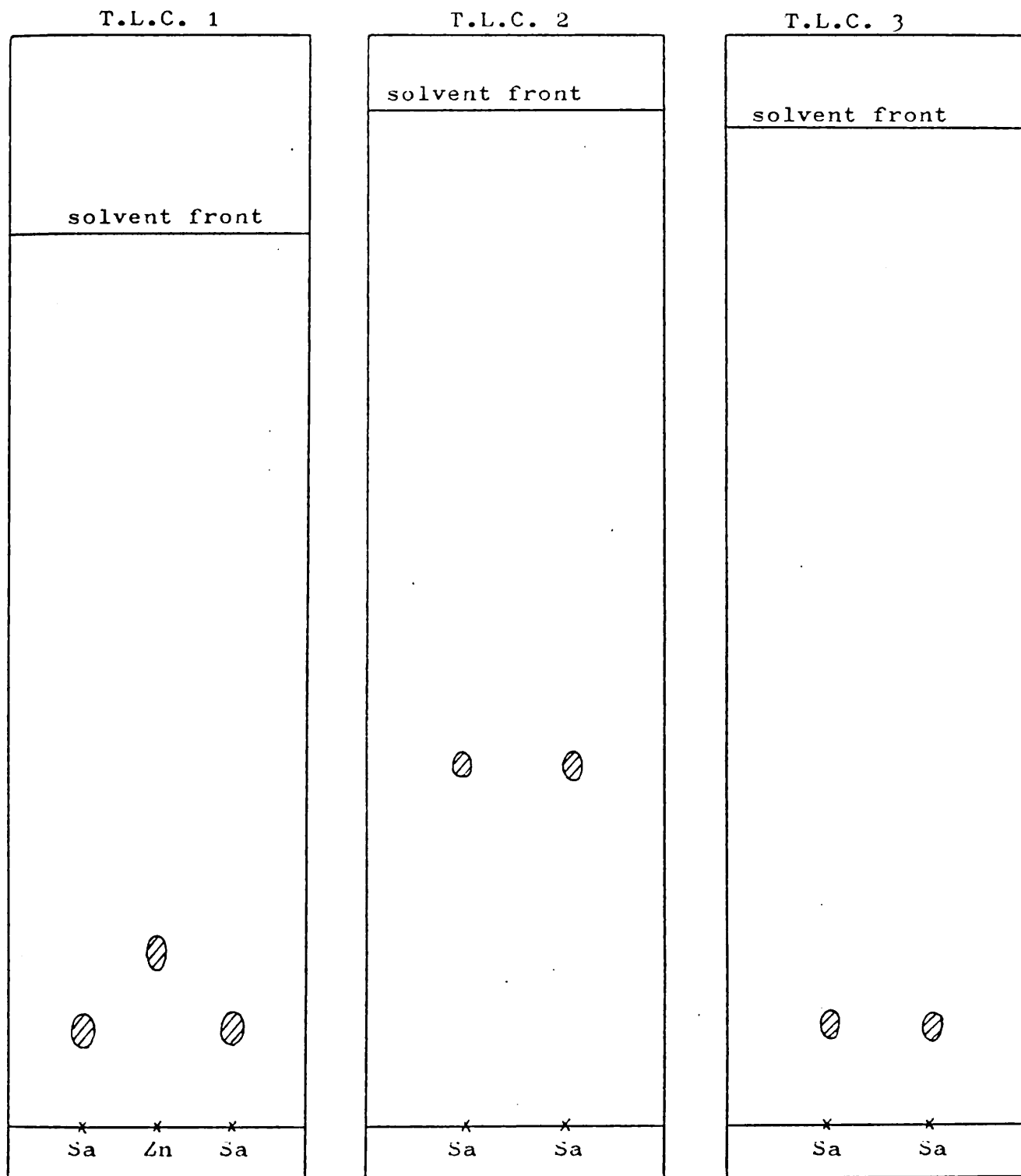

Indicator 1 Dithizone 2 Aminodiphenyl-phosphoric acid
3 Anisidine-phthalic acid

Plates 1 Cellulose 2 Silica gel 3 Silica gel

Solvent 1 Butanol/acetic acid/water 12/3/5
2 Benzene/acetic acid/methanol 1/1/3
3 MEK/acetic acid/methanol 3/1/1

A chromatographic system involving silica gel plates treated with boric acid, developed with methyl ethyl ketone/ acetic acid/methanol (3/1/1, by volume) and employing the hydrolysed complex, was set up and a brown colour with the above reagent was observed at an R_f value of 10 (TLC3). This is the value of D-galacturonic acid in the literature (Zweig and Sherma (1972)).

The brown colour was not seen at the R_f value of the complex in the original system although a sugar was observed there with p-anisidine-phthalic acid. In addition, hydrolysis appears to increase the concentration of D-galacturonic acid. Pure D-galacturonic acid was subsequently run in the above systems and found to confirm the identification.

c) Conclusions

D-galacturonic acid appears to be present in the zinc complex found in aqueous extracts of Polycarpaea glabra stem material. Because there was an increase in concentration of D-galacturonic acid on hydrolysis, the carbohydrate units are probably linked in the complex. Thus the complex will not be retained on a Sephadex column for any great length of time and would show a large degree of dissociation (zinc is a poor complexing metal even with sulphur, its best electron pair donator). The presence of high concentrations of other metals would certainly dissociate the complex as would most electrophoresis and chromatographic systems.

Hence there is a general consistency in the conjecture that the water soluble complex of zinc from Polycarpaea glabra stems is a D-galacturonic acid containing compound, a pectinate.

To reduce the possibilities of alteration of the complex during extraction, the ground material was extracted for one minute, roughly centrifuged and rotary evaporated. The final extract was placed on a Sephadex column within five minutes of the deionized water being added to the sample. After separation the extracts were run immediately. Identical R_f values and reagent colours resulted.

Although dissociation took place over a prolonged period of time, the stability of the complex was unaffected by increased temperature. The sample solution was kept at 85°C for five minutes without alteration of the zinc complex.

It would appear from the properties of the complex that any tolerance to zinc exhibited in Polycarpaea glabra is more likely to be due to the positioning of the metal away from metabolic sites than to its chemical combination. A complex which gives up the metal in the presence of other metals and in the proximity of many solids (e.g. in chromatography columns) and within an electrical potential difference (albeit a large one) suggests little chemical removal of zinc from biochemical reactions. Hence, a zinc accumulation site away from ribosomes and mitochondria (Rao et al. (1966)) may well exist for Polycarpaea glabra. This is investigated in chapter IV.

The ligand present in the zinc complex from the ethanolic extract of Polycarpaea glabra flowers was investigated but could not be identified. High concentrations of the complex, the dissociated complex and the hydrolysed complex on chromatograms were sprayed with a large range of identification reagents, but the ligand could not be characterised.

Finally, the aqueous extract of Crotalaria nova hollandiae

stems and leaves contained zinc indistinguishable from Zn^{2+} ions.

3.6 Copper and Iron

From chapter II it may be seen that Polycarpaea synandra and Helichrysum leptolepis possess the greatest concentrations of copper in their tissues. Helichrysum leptolepis also has the greatest concentrations of iron.

Ecbolium lugardae has a higher concentration of iron than Polycarpaea synandra, but almost none of it is soluble. Hence, Polycarpaea synandra and Helichrysum leptolepis were examined for soluble metal complexes.

The preparations of the test solutions were identical with those performed for zinc. The fractions examined were the aqueous extracts of stem material for both plant species. Oxine was originally employed for copper identification but because of its rather faint yellow colour with the metal and lack of sensitivity, diethyldithiocarbamate, followed by ammonia vapour, was later employed. For location of iron, potassium ferrocyanide and potassium ferricyanide were employed.

For phenol/water as developing reagent, iron remained at the origin in both plants, indicating the unlikely possibility that the metal was present as its ions. For butanol/pyridine/water the iron was also located at the origin, proving that an iron complex was present ($R_f \text{ Fe} = 31$)

For Polycarpaea synandra material copper was located at the origin in the phenol/water system but at R_f values of 20 and 84 with butanol/pyridine/water suggesting the presence of copper complexes ($R_f \text{ Cu} = 72$). With Helichrysum

leptolepis extract, however, copper was located at $R_f = 93$ (R_f Cu = 0) using phenol/water and at values 21, 70 and particularly 92 using butanol/pyridine/water as developing reagent. Again the metal is not present as Cu^{2+} ions in this extract. The copper complex from Helichrysum leptolepis is further examined in the next section (3.7).

Developed chromatograms employing the above systems were sprayed with anilinium phosphate and ninhydrin. No sugar spot could be seen but blue-purple stains with ninhydrin were observed at a number of different R_f values including those of the copper spots. Identification reagents for other ligands were applied to developed chromatograms but with uniformly negative results.

3.7 Copper-Amino acid Complexes in Plants

There are good grounds for examining copper complexes from plants for amino acid ligands. Firstly, the major complexes of copper found in plants have always been amino acid related complexes (Mills (1954), Reilly et al. (1970)). Secondly, the general level of copper, particularly for Helichrysum is very high and some method of resistance to copper toxicity must be present. All the examples to date of the complexation method of tolerance have involved combination of the metal involved with amino acids (Arakatsu and Ashida (1956), Cannon (1960)). Thirdly, there are a number of examples of direct correlation between copper and nitrogen in plants (e.g. Gilbert (1951)), the argument being that as the copper content increased, the organism is able to synthesize amino acids to complex with it (Arakatsu and Ashida (1956)). Fourthly copper is known to form very stable

complexes with amino acids and as copper and amino acids were certainly present in the extracts, complexation is a distinct possibility.

Just under one quarter of the copper in a sample of Helichrysum leptolepis leaves was present in a form soluble in hot water. Running this fraction in a number of paper chromatographic systems revealed, as expected, amino acid and copper intimately connected at R_f value different from that of the pure Cu^{2+} ion. (Other amino acids were also observed). Hence, a chromatographic investigation of copper-amino acid complexes was undertaken which included the copper complexes of all the natural amino acids found in plants and involved a number of different solvent systems and conditions.

a) Procedure

13g Helichrysum leptolepis leaf material was ground and shaken with 250 cm^3 deionized water for a total of 24 hours. The liquid was decanted off and centrifuged at 1500 r.p.m. for 12 hours. (Later, separation by suction through a millipore filter was found to be as effective and far quicker than centrifugation). The resultant solution was concentrated by evaporation on a rotary evaporator or freeze drier, thus reducing the volume to about 0.5 cm^3 . This solution was passed through a Sephadex-52 column and extracted with diethyl ether.

The copper-amino acid complexes were prepared after the method of Fare and Sammons (1966). The acids used were:-

1	Glycine	12	l-serine
2	l- α -alanine	13	l- β -phenyl- α -alanine
3	l-threonine	14	l-methionine
4	l-valine	15	l-leucine
5	l-cysteine	16	DL-glutamic acid
6	l-proline	17	l-tyrosine
7	l-cystine	18	DL-aspartic acid
8	l-hydroxyproline	19	l-arginine
9	l-isoleucine	20	l-lysine
10	l-tryptophan	21	l-asparagine
11	l-hystidine	22	l-glutamine

The sample and standards were spotted onto 30 cm x 30 cm Whatman Number 1 chromatography paper and developed by the ascending method. A variety of developing reagents were employed of which phenol/water and butanol/pyridine/water solutions were the most important. Other systems and results of general copper-amino acid complex identification are given in the appendix III.

Identification reagents employed initially were ninhydrin for amino acids, oxine for copper when using the methyl ethyl ketone/hydrochloric acid/water and butanol/pyridine/water systems and diethyldithiocarbamate for copper in other systems (see appendix II for concentrations). Subsequently, α -pyridylazo- β -naphthol was employed to locate copper (De Kock (1956)) and was found to be fairly specific and extremely sensitive.

b) Results

The R_f values of copper and amino acid spots on

Acid complex	R _f Cu	R _f Amino-acid (complex)	R _f pure amino-acid	Literature value (amino-acid)
1	71	32	31	29
2	70	36	35	37
3	68	35	37	36
4	70	49 69	42	48
5	71	16	14	14
6	70	37	41	34
7	72	16	17	15
8	69	-	36	30
9	78	64 79	58	56
10	78	62 78	58	62
11	19	20	31	24
12	72	33	34	33
13	76	61 77	63	63
14	72	54 71	56	53
15	71	61 75	68	60
16	69	21	24	20
17	74	60 71	69	60
18	38 67	20 37	18	17
19	14 69	17	15	15
20	11 70	14	14	13
21	20 70	22	22	20
22	25 70	27	23	23
Cu ²⁺ ions	72			
sample	21 72 70 12	92		

Table III

R_f Values for Acid-Copper Complexes

Using Butanol/Pyridine/Water (1/1/1, by volume)

Acid complex	R _f Cu	R _f acid	R _f free acid	Literature value
1	75	39 75	39	42
2	94	94	63	58
3	84	84	47	48
4	99	99	83	78
5	95	20	28	22
6	93	93	92	90
7	93	16	16	15
8	78	78	68	67
9	99	99	85	85
10	100	76	75	77
11	96	96	69	65
12	54	32 54	35	35
13	97	84 97	87	71
14	99	79 99	81	82
15	99	84 99	85	85
16	22	22	24	33
17	98	62 98	63	60
18	25	24	20	20
19	70	73	62	83
20	45 54	45	41	42
21	57	56	40	40
22	77	77	29	27
Cu ²⁺ ions	0			
sample	93	25 66 93		

Table IV

R_f Values of Amino Acid-Copper Complexes

Using Phenol/Water (4/1, by mass)

chromatograms developed with butanol/pyridine/water (1/1/1, by volume) are shown in table III, and those on chromatograms developed with phenol/water (4/1, by mass) are shown in table IV.

c) Conclusion

It may be seen that for butanol/pyridine/water complex dissociation has frequently occurred. For example, in the first three complexes copper appears at the R_f value of copper ions and the amino acids at the value of uncomplexed acids. However, in both systems two ninhydrin located spots often appear, the more advanced spot superimposed on the copper, and the slower spot at the R_f value of the uncomplexed acid. The complexed acid is usually more mobile than the uncomplexed molecule.

In the phenol/water system, where no observable dissociation of complexes occurred, the purified, extracted sample gave a colouration with α -pyridylazo- β -naphthol at an R_f value of 93, and a yellow spot with ninhydrin at the same value. The proline-copper complex gives the identical colours and R_f values as those found for the sample copper complex. However, uncomplexed proline also occurs at approximately this R_f value. No free Cu^{2+} ions were detected in the sample.

In the butanol/pyridine/water system the sample showed three copper spots with R_f values of 21, 70 and 92. The spot at $R_f = 21$ was very faint and corresponded only to the histidine-copper complex (11) as asparagine (21) and glutamic acid (22) complexes had been eliminated in the phenol/water system. However, histidine is normally present in

extremely small concentrations in plants. The second spot, also faint, suggests some dissociation had occurred. The third copper spot was very highly coloured and occurred at a point corresponding to no simple amino acid complex. Hydrolysis of this compound (eluted from the paper with the developing solvent) and analysis in an amino acid analyzer proved it to be a protein of the following composition:-

<i>mole fraction</i>					
Aspartic acid	0.107	Alanine	0.056	Tyrosine	0.063
Threonine	0.053	Cystine	0.001	Phenylalanine	0.038
Serine	0.062	Valine	0.060	Lysine	0.060
Glutamic acid	0.163	Methionine	0.001	Histidine	0.038
Proline	0.065	Isoleucine	0.058	Arginine	0.052
Glycine	0.071	Leucine	0.063		

3.8 Electrophoresis of Iron and Copper Complexes

Finally, the iron and copper complexes of Helichrysum leptolepis were tested at different pH's on paper electrophoresis. Using acetate buffer (pH 1.9) and 320V it was found that the iron and copper moved slowly towards the negative electrode at the same rate as Fe^{2+} and Cu^{2+} ions. The same result was achieved at pH 6.7.

(The iron citrate anion has been found transported in the xylem of plants (Tiffin and Brown (1962)). Although almost certainly present, it was in too low a concentration to be observed).

3.9 Summary

Soluble metal complexes have been found for zinc, copper and iron in plant material. Two soluble zinc complexes

have been found in Polycarpaea glabra, one predominating in the stems and the other in the flowers. The stem complex is comparatively stable (with respect to the other zinc complexes), has low mobility in butanol/acetic acid/water (12/3/5, by volume) and dissociated with many other systems and in the presence of other metal ions. It was found to be a zinc pectinate.

The flower complex of zinc is relatively unstable to heat, low pH, other ligands and a number of chromatographic systems. All the zinc present in the aerial parts of the plant species was bonded, no uncomplexed zinc was found. This was not the case for Crotalaria nova hollandiae, however, where all the soluble zinc (which was the majority of the zinc present) was found as Zn^{2+} ions.

A copper complex and an iron complex were both found in Helichrysum leptolepis material both of high stability to heat but not to other ligands. The copper complex consisted of the metal ion coordinated to protein.

3.10 Determination of the Concentration of Zinc in Protein in Polycarpaea glabra Stems by Levitt Method

Finally in this chapter, an attempt was made to find the concentration of the zinc bonded to soluble protein in Polycarpaea glabra stem material. Initially, because of the presence of a protein of similar R_f value to the zinc complex, it was believed that the aqueous extract contained a zinc-protein complex. This experiment was designed to confirm this.

a) Method

In duplicate, approximately 4g freeze dried sample material was extracted to remove the protein by the method of Levitt (1951), that is the material, after ether and aqueous extraction, was washed in buffer solution (pH 7.0), filtered and an ammonium hydroxide-ammonium sulphate mixture added to precipitate the protein. This was filtered off, collected and resuspended in water. The solution was dialyzed for two days when it was evaporated to dryness and wet ashed. The solution remaining from the protein precipitation was analyzed for zinc, the pectate precipitated with ethanol and the solution reanalyzed on the atomic absorption spectrophotometer.

b) Results

The findings are given in table V.

c) Discussion

These results are in exceptionally good agreement with the original extractions in chapter II. The ether and aqueous ethanol readings are very close and it may be seen that only 7 ppm of the original 396 ppm of zinc complex soluble in water are present as the protein. 396 ppm zinc was extracted in water of which 350 ppm was left in solution after precipitation of protein. Thus 46 ppm came down with the protein. After dialysis only 7 ppm remained in the protein.

It is possible that when the protein came out of solution the conformation of the protein in the zinc metal complex was altered and released metal ions into solution. This is

Wet Ashing (chapter II)

Sum

Digest

Solution

Soluble Protein

Aqueous Ethanol

Ether

795

705

244

350

7

90

14

Polycarpaea glabra stem

Solution after pectate precipitation 45 ppm

Metal lost in dialysis 39 ppm (by subtraction)

Table V

Concentrations of Zinc (ppm) in Polycarpaea glabra Stem Material

Extracted and Precipitated with Various Solvents

checked in the following experiment. However, it appears more likely that the zinc complex found in aqueous extractions of Polycarpaea glabra stem is not the metal-protein complex expected. This was confirmed in later chromatographic work (see p. 91).

3.11 Determination of the Concentration of Zinc in Soluble Protein and Pectate in Polycarpaea glabra Stems by the Sevag Method

The Sevag method (1938) of protein removal involved treating the aqueous extract with chloroform into which the protein passed. After vigorous shaking the two liquids were separated and the chloroform allowed to evaporate, leaving the protein. The advantages of this method are that there is no solid precipitate in the aqueous extract onto which otherwise soluble zinc ions or compounds may adsorb. Also the proteins pass into the chloroform layer with little change in conformation and hence, less likelihood of releasing the metal during separation.

Unfortunately, little of the material used in the Levitt determination remained and a new sample from the same batch gave a different value for zinc concentration (i.e. 672 ppm as opposed to 795 ppm - this may well represent merely a greater green-brown stem ratio). This will be seen, however, to be of little consequence.

a) Method

A weighed mass of Polycarpaea glabra stem material, dried and ground, was taken through the following devised extraction and precipitation scheme (Fig. XIV). All the

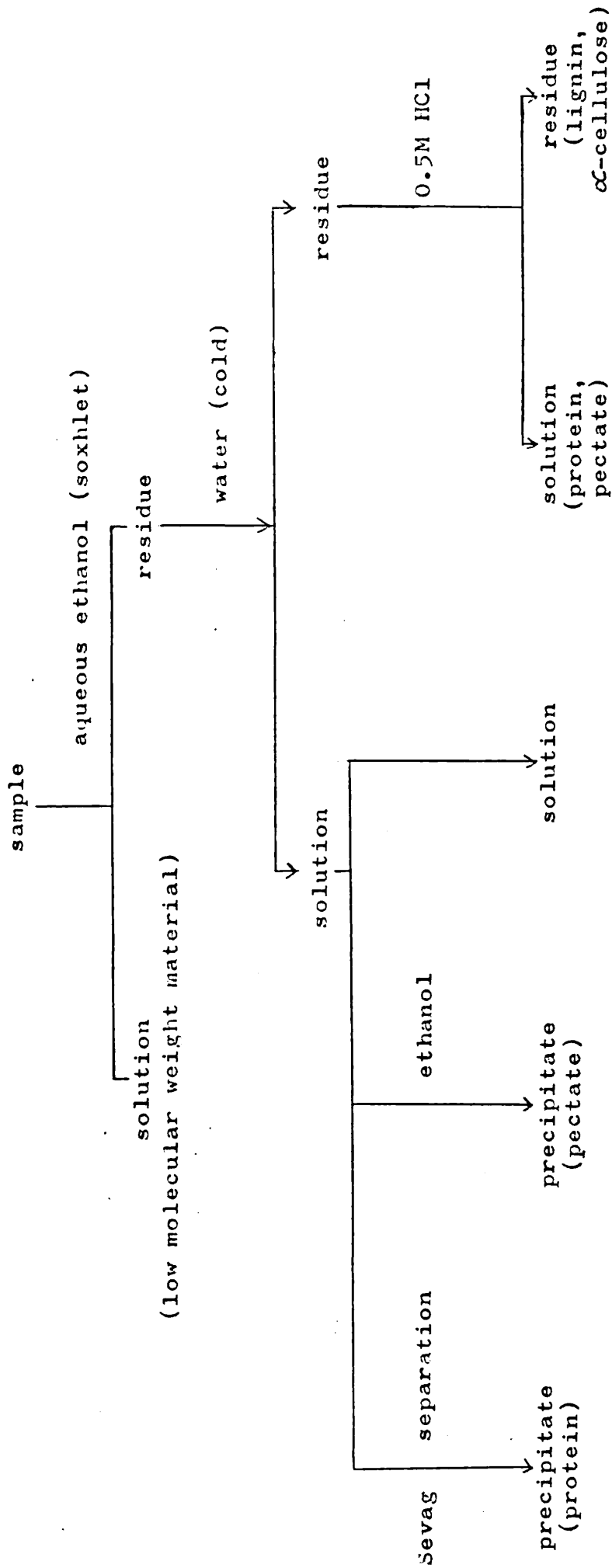

Fig. XIV

Extraction scheme for Polycarpaea glabra stem

involving the Sevag separation of proteins

solutions obtained were evaporated to dryness in the usual manner and the precipitates were centrifuged down, separated and wet ashed.

b) Results

The readings of zinc concentrations for the factions in the above scheme are shown in table VI.

c) Conclusions

As may be seen from table VI very little of the zinc in the sample appears to be present as water soluble proteins. (The original zinc complex R_f value and concentration were unchanged with protein removal). By far the largest concentration of soluble zinc comes down with the fraction normally considered to be pectate. The removal of zinc from solution with pectate precipitation may be merely ion adsorption onto the surface of the pectate or "sympathetic" precipitation by other chemical species may occur. However, the relatively high concentrations of zinc that were precipitated, together with the fact that little adsorption occurred onto the surface of a considerable quantity of protein in the Levitt precipitation, lends credence to the suggestion that the precipitated zinc was associated with pectin.

3.12 Discussion

It is probable that the new sample of stem material contained a greater proportion of green stem material than the old sample. The total concentration of zinc was down on the original value by approximately 120 ppm and this

	Aqueous ethanol	Water	0.5M HCl	Residue	Sum	Wet ashing
<u>Polycarpaea glabra</u>		269				
stem material (ppm)	68	(calculation)	296	10	642	672

protein 10 pectate 239 remainder 20

Table VI

Results of extraction scheme

is about the value of the decrease of the water soluble concentration. It was noted in chapter II that specifically green stem differed from a mixture of green and brown stems by the same value that the water extract differed. All other fractions appeared to stay approximately constant.

Another point of interest arises from a comparison of the Levitt precipitation and the extraction of Polycarpaea glabra reported in chapter II. The earlier work employed hot water to extract zinc soluble compounds, whereas Levitt used cold water plus a buffer solution. Approximately 400 ppm zinc was extracted in hot water and over 350 ppm with cold water plus buffer. It is possible that the buffer displaces some of the metal which is then taken up by the pectate.

The overall results of these experiments, however, leave little doubt. The zinc is not bonded with protein as was suspected earlier in chromatographic work but is associated with pectins. This is in complete agreement with the later work on Polycarpaea glabra material, which demonstrated zinc bonded to a carbohydrate and, indeed, to D-galacturonic acid, the basic unit of pectin polymers.

Chapter IV

Investigation of Insoluble Metal Compounds and Metal Accumulation Sites

4.1 Introduction

In chapter I a broad summary was given of the chemical character of compounds containing high concentrations of metals found in some plants. For example, many plant samples examined possessed high proportions of soluble metal compounds e.g. Astragalus stoloniferi (Cannon (1960)), Saccharomyces ellipsoidus (Arakatsu and Ashida (1956)), Becium homblei (Reilly et al. (1969)). Much of the previous work on tolerance, however, has found the majority of heavy metal in plants to be insoluble in ether, aqueous ethanol and water, e.g. Bradshaw et al. (1965), Turner (1967) and Turner and Marshall (1972).

It was found in the previous chapter that the major zinc containing compound in the stems of Polycarpaea glabra species grown on a high zinc site was a water soluble pectinate. For Crotalaria nova hollandiae the majority of zinc in both stems and leaves was present in water soluble form, apparently as unassociated Zn^{2+} ions. However, for both these species high concentrations of the metal remained insoluble in ether, aqueous ethanol and water. It is this fraction which will now be discussed. The method used for this is the extraction scheme of Peterson (1969), involving the use of the proteolytic enzyme, pronase.

4.2 Determination of the Compounds Associated with Insoluble Zinc in Polycarpaea glabra and Crotonalaria nova hollandiae Species

a) Method

A known mass (approximately 1 - 2g) of ground Crotonalaria nova hollandiae plant material (rather more Polycarpaea glabra) was taken through the procedure shown diagrammatically in Fig. XV. All the solvents in the diagram were added in the order shown to the material in 250 cm³ conical flasks. 150 cm³ of solution were added each time. The flasks were stoppered and shaken for 12 hours before being centrifuged and the extract decanted off. This solution was then taken to dryness in a rotary evaporator, wet ashed and assayed for the metal using the atomic absorption spectrophotometer.

Protein was extracted in the scheme after the method of Butler and Peterson (1967) using the calcium containing enzyme pronase. This is a useful, general proteinase (it breaks the peptide link in proteins, yielding amino acids). Unfortunately, it was found to possess a small proportion of zinc, so that the method was modified by reducing the mass of pronase used and increasing the mass of sample. The limit of the process was found by experiment. In addition the mass of pronase added to the sample and blanks were measured to three places of decimals and hence, the zinc added in the pronase could be eliminated.

Thus, approximately 1.6g of plant material was used as against 300mg pronase. 150 cm³ of pH 7.5 buffer was added together with 3mg chloramphenicol. The mixture was shaken

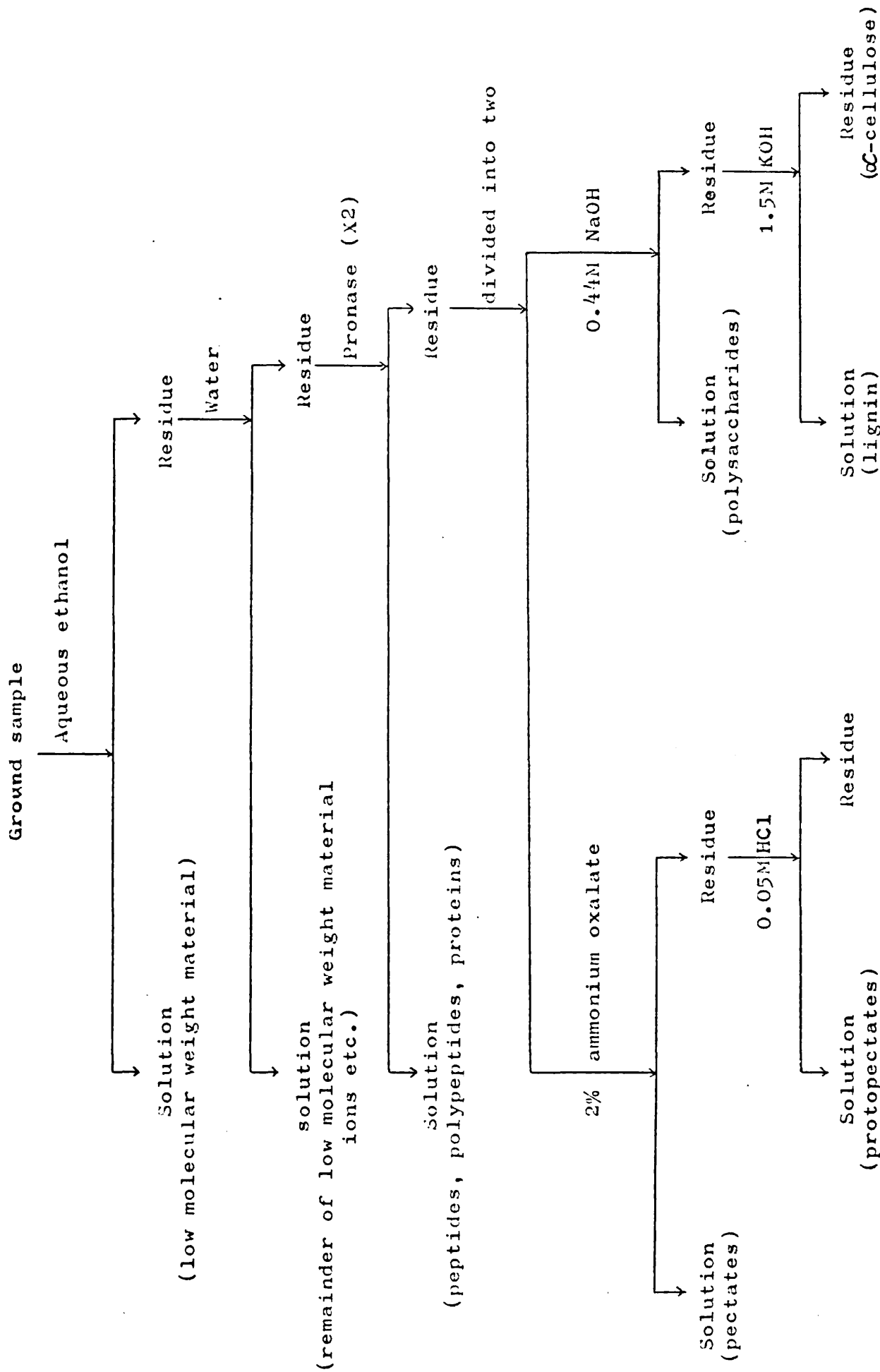

Fig. XV Extraction Scheme for Water Insoluble Metal Compounds (Peterson (1969))

for about 40 hours. The procedure was repeated, the extracts pooled, rotary evaporated and wet ashed. The residue was then divided into two more or less equal parts, dried, weighed and separately extracted with the various solvents.

In addition to the high zinc stem material of Polycarpaea glabra and Crotalaria nova hollandiae examined, Polycarpaea glabra samples from a low zinc area (see appendix) were included for rough comparison and also, Crotalaria nova hollandiae leaf was examined.

b) Results

The table below gives the concentration of zinc among the various chemical groups of compounds present in the insoluble fraction of plant material.

c) Conclusions

It may be seen that the majority of zinc in the highly mineralized Polycarpaea glabra sample is present in the pectate fraction. This explains the high concentration in general polysaccharides. In addition, although the level of zinc associated with soluble protein was found to be quite low (section 3.10 and 3.11), that associated with insoluble protein may be seen here to be much higher (> 10 times as high). Very little zinc was found in α -cellulose, lignin or other fractions.

The figures obtained here give a total of about 60 ppm in excess of the wet ashing value given in section 3.11 i.e. 672 ppm. In the Peterson scheme the residue, already extracted with aqueous ethanol, water and pronase was divided into two and reweighed. The resultant values obtained

	Protein	Polysaccharides	Pectates	Protopectates	Residue	Lignin	α -Cellulose
<u>Polycarpaea glabra stem</u> (high Zn)	100 (ppm)	289	251	52	-	-	5
<u>Polycarpaea glabra stem</u> (low Zn)	80 (ppm)	110	80	40	-	-	-
<u>Crotalaria stem</u> (ppm)	384	1298	1448	119	36	54	53
<u>Crotalaria leaf</u> (ppm)	432	1691	1771	250	108	42	48

Table VII Table of Extraction Results of Water Insoluble Zinc for

Polycarpaea glabra and Crotalaria nova hollandiae Sample Material

will thus be marginally higher than they should be. The sum of these surpluses could easily exceed 60 ppm.

In contrast to high zinc samples, low zinc Polycarphaea glabra samples were found to possess surprisingly little zinc in the pectate, and polysaccharide fractions.

For the Crotalaria nova hollandiae sample again, the dominant fraction for water insoluble zinc is the pectate fraction. The proportions of zinc in the various fractions of stem and leaf is approximately the same (although there was a very high residue after acid extraction of leaf material). The major difference in zinc distribution amongst solvents in stem and leaf material for the species is the very high level of water-soluble zinc in leaves (noted in section 2.2). The results here are in excellent agreement with those results in chapter II, though the polysaccharide level in leaves is possibly a little low.

d) Discussion

Though applied by Peterson (1969) to the extraction of radioactive tracers from plant material, it can be seen here that the method is applicable to large scale extractions of zinc (for other metals with insoluble hydroxides, for example, large scale extraction using this scheme is not possible). The results obtained here, together with those found in chapter III for Polycarphaea glabra, indicate that a very high percentage of zinc is present associated with pectate. A rough calculation gives 251 ppm (insoluble pectate) and 239 ppm (soluble pectate) which equals 490 ppm in total. This is 73% of the total zinc present in stem material. For

Crotalaria nova hollandiae the same type of calculation

cannot be made because a soluble zinc-pectate complex did not occur to any measurable extent. However, of the insoluble zinc the great majority was found present with the pectate.

As noted in the Introduction (chapter I) the basic unit of which pectates are comprised is the D-galacturonic acid molecule (though rhamnose and galactose are also present). These units combine in β 1-4 linkages to give polygalacturonic

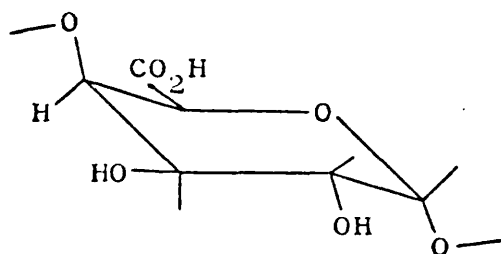

D-galacturonic acid unit

acid chains. The $-\text{COO}^-$ and $-\text{OH}$ groups can donate electron pairs to metal cations and in most cases a sparingly soluble compound results if most metal sites are occupied (Jellinek and Sangal (1972)). The maximum ratio of metals to uronic acid units is 0.7 (Muzzarelli (1973)).

Decrease of pH to 4.5 releases 75% of most complexed metals. Thus metals in solution may be collected by complexation and precipitation, and the polymer regenerated by addition of dilute acid. The affinity of ions in solution for the polymer decrease in the order Cu, Cd, Zn, Ni (Jellinek and Sangal (1972)). However, this is merely a tendency and not a specificity. Copper is twelve times more likely to be complexed than is calcium.

Thus, pectate chelates with a number of divalent (and univalent) ions involving both $-\text{OH}$ and $-\text{COOH}$ groups. With most metals the $-\text{OH}$ groups must belong to the same uronic

acid residue. Metal pectates appear to be of two types, intermolecular and intramolecular and these are in equilibrium (Schweiger (1966)). Most metal pectates favour the intermolecular form (between two polymer chains) but zinc is found primarily in the intramolecular form. It is most probable that zinc is chelated in the manner with the pectin layer of cell walls in Polycarpaea glabra.

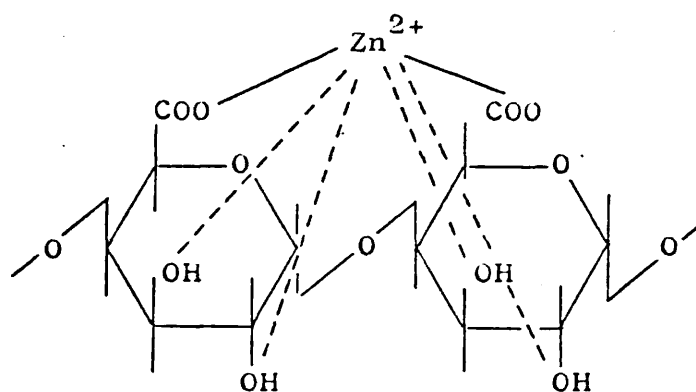

Intramolecular bonding of zinc in pectates

With regard to interpretation of these results, an attractive conjecture may be cautiously proposed, that as Polycarpaea glabra plants take up higher concentrations of zinc, the pectate fraction becomes an accumulation site, storing the majority of the excess zinc. This is exactly what appears to occur with Agrostis tenuis (Turner and Marshall (1971)). However, the plant samples here originate from two different sites, one with high and the other with low zinc soil levels; other major differences in growing conditions also exist (section 2.1). In addition the metal concentrations in the stem tissues of one sample is very much higher than the other, so that a direct comparison of the two cannot strictly be made. The low zinc plant, for example, may well possess a completely different distribution of metal than

the high zinc plant if grown on the same site.

4.3 Determination of accumulation site within the plant

1. Histochemistry

This classical technique is rarely employed in studies of heavy metals in plants, primarily because the metal concentrations are generally too low. However, in this work samples were chosen for their high metal concentrations. Now, if accumulation of a metal occurs at a distinct site, the local concentration may well be higher than the sensitivity limit of the indicator. This is particularly relevant to the histochemistry of zinc where the stain, dithizone, has a very high sensitivity.

The general technique is simply to harvest the plant, section the plant part required (the section is generally thicker than normal to show up the stain), kill the cells and stain with a chemical which will colour the particular compound or element being examined. Then mount, draw or colour-photograph the section.

Ideally the stain chosen should be colourless itself, specific for the chemical species required, form a highly coloured, insoluble compound and be comparatively sensitive. These are a difficult set of requirements to meet, however.

a) Method

Leaf and stem material were taken from the plant sample, washed and immersed in either absolute ethanol or a 1:1 by volume ethanol:glycerol mixture. They were then sectioned for the light microscope. A microtome was not employed as

extended preparation of material for sectioning may alter the distribution of the metal within the tissues. The sections were then subjected to the procedure dictated by the particular stain used (Gurr (1958), Pearse (1968)).

The stain used for zinc was that of Mager et al. (1953) based on dithizone with potassium cyanide as masking agent. It is specific for zinc in the context of the metals present in the plant samples, it does not colour any plant tissue free of zinc and is also extremely sensitive.

The stains used for copper were:-

Rubeanic acid - greenish black precipitate with copper

Diethyldithiocarbamate - golden brown precipitate

Hematoxylin - blue

Oxine - yellow

Methylene blue was also recommended (Gurr (1958)) for copper but as it is itself highly coloured and gave a general blue colour to most structures, it was found to be unsuitable for copper location.

The stains used for iron were:-

Dimethylglyoxime - red solution with iron

Hematoxylin - black precipitate

Ferrocyanide - blue precipitate

Ferricyanide - blue precipitate

Cupferron - red solution

Phenanthroline - red solution

Thiocyanate - red precipitate .

b) Results

In all the slides of Crotalaria leaf the stain is the dithizone stain of Mager (1953) which gives a bright red

colour with zinc.

Slide I shows the cross section of the central vein of a leaf. It can be seen that phloem is stained bright red indicating the presence of zinc. Slide II shows in greater magnification the junction between xylem and phloem, and clearly, there is a very sharp contrast in zinc concentration in the two structures. Slide III gives a transverse section of a vein in the leaf, again illustrating the high concentration of the metal in the phloem as opposed to the xylem. Zinc was also found in the walls of the epithelium cells and in the cuticle. Slide IV gives a view of this area showing the outer and inner walls of these cells, but not the lateral walls, stained red. This may well be contamination on the leaf surface but, in any event, the zinc level here is comparatively low compared with phloem concentration as may be seen in section 4.3.4 on the electron probe analysis.

These results are in sharp contrast to sections of low zinc Crotalaria which show no red colour.

For stem material distinct areas of high metal accumulation could not be found. The general level of mineralization is, of course, much lower than in leaves and the metal appears to be spread right across the stem. This is confirmed in section 4.3.4. Spraying the cut end of the stem with the stain gave a bright red colour seen with the naked eye.

In contrast to the Crotalaria species Polycarpaea glabra did not stain well. No red colour could be seen, in general, indicating an accumulation site for zinc. However, for one particular sample very interesting results were obtained.

Slide I

120

Crotalaria nova hollandiae

Cross-section leaf vein

(x 100)

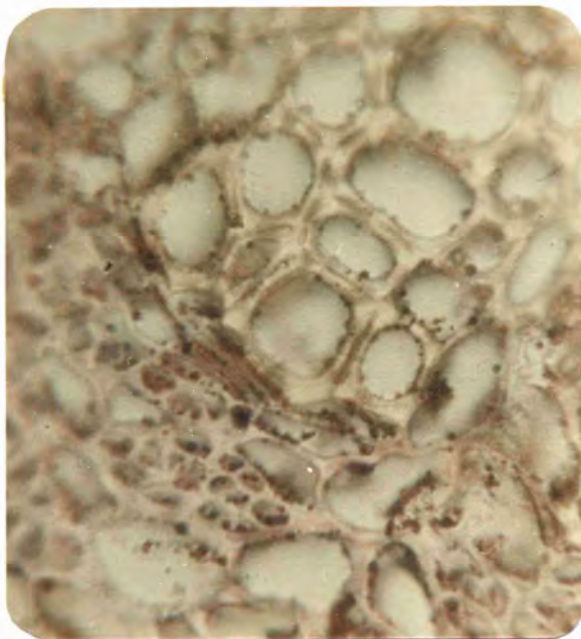
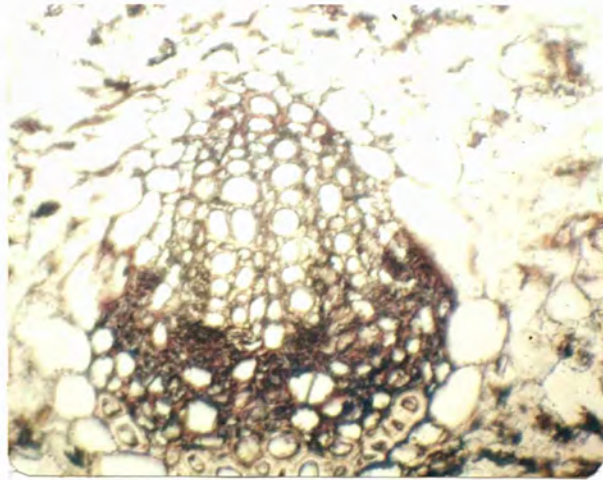

Slide 2

Similar to the above

(x 450)

Slide III

Crotalaria nova

hollandiae

T.S. leaf vein

(x 450)

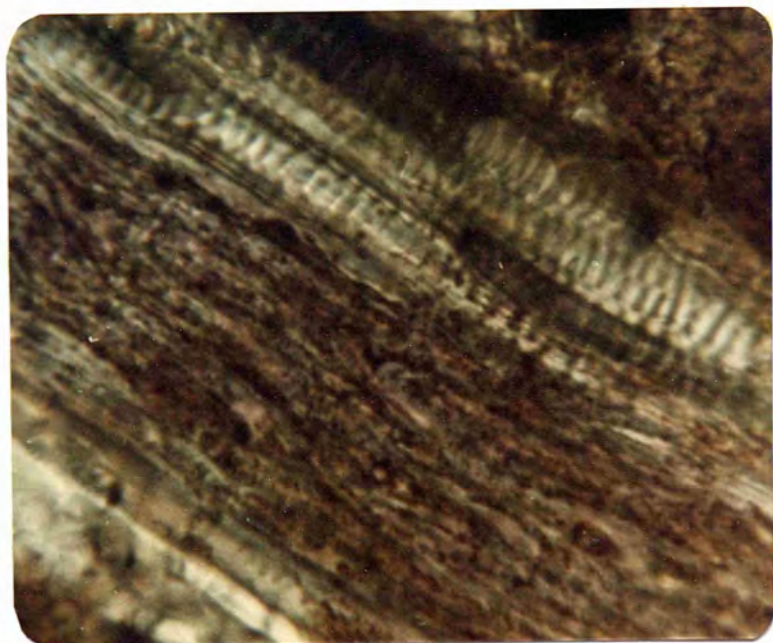

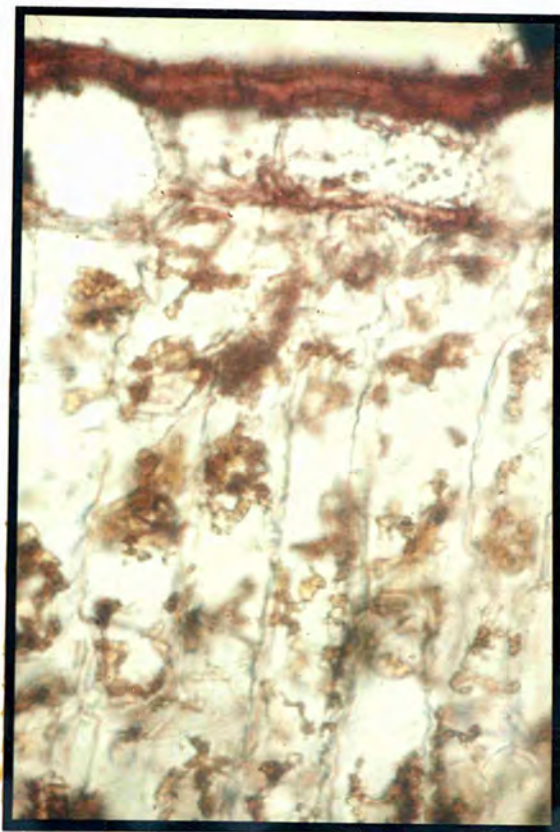

Slide IV

Crotalaria nova hollandiae

Cross-section of leaf (x 100)

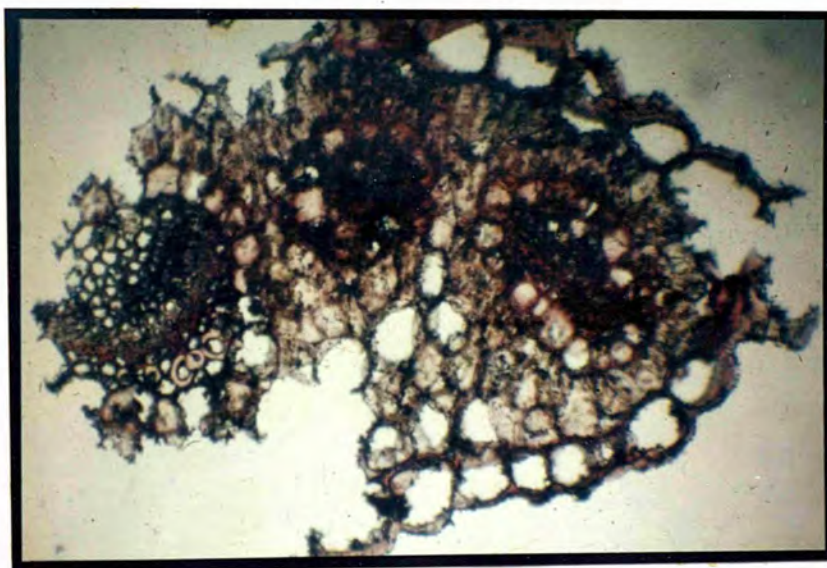

Slide V

Polycarpaea glabra

Cross-section of leaf (x 100)

Slide V shows a cross-section of the leaf, the central canal is on the left. In addition to the cuticle and epithelium cell walls being faintly red, the cell walls surrounding the vascular canals were distinctly red.

Finally, immersing the sections for a few minutes in either 0.5M hydrochloric acid or 50 ppm Ca^{2+} solution before washing and staining prevented the colour from forming. These reagents appeared to remove the bulk of the metal from its accumulation sites (see section 4.2 (d)).

Copper could not be detected in any of the plant species with any of the five stains employed. From the wet ashing values of total metal concentration given in chapter II it can be seen that only Polycarpaea synandra and Helichrysum leptolepis possess high copper concentrations in their tissues. Slides VI (1/7) and VII (2/1) are cross-sections of leaves of these species stained with methylene blue. Though of little use here as a copper indicator (Gurr (1958)) the general structure of the leaves are well shown. Between the vascular canals of Polycarpaea synandra leaf material calcium oxalate crystals are present; these are found naturally in many plant species. The furry covering of Helichrysum leptolepis stem and leaves, which probably functions in insulation and water conservation, and which made grinding of the material for analysis so difficult, can be seen in slide VII (2/9) to be normal leaf hairs, though in great abundance. Slide VIII(3/6) and IX are cross-sections of the central vein of a leaf of Ecboium lugardae showing the general vascular structure stained with methylene blue.

For iron, dimethylglyoxime, ferrocyanide, ferricyanide and hematoxylin were found not to stain any of the sections.

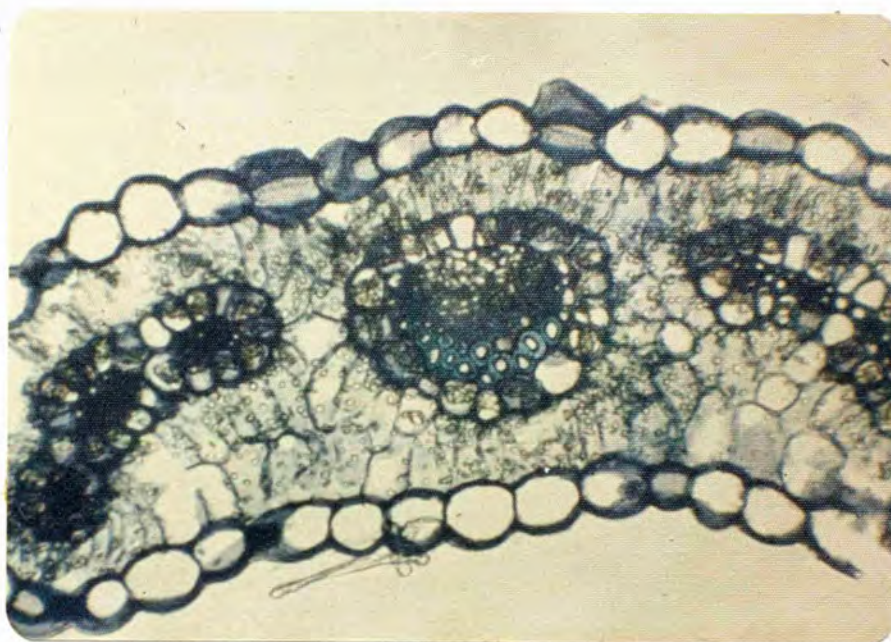

Slide VI

Polycarpha synandra

Cross-section of leaf (x 100)

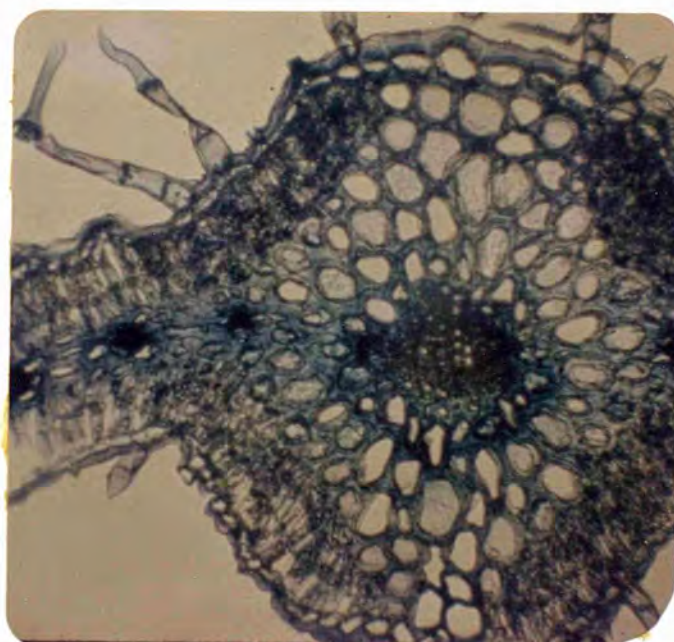

Slide VII

Helichrysum leptolepis

Cross-section of leaf (x 100)



Slide VIII

Ecbohium lugardae leaf cross-section

(x 100)

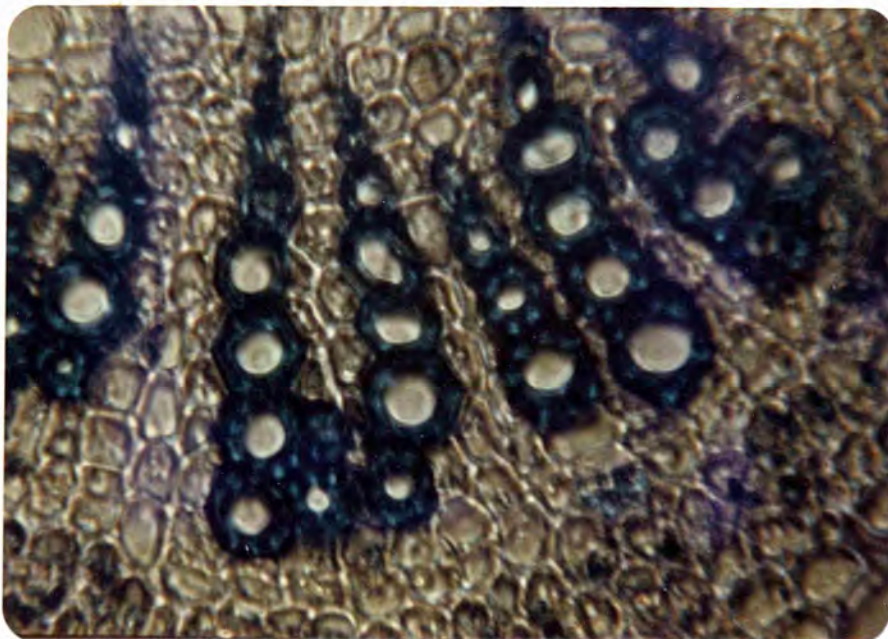

Slide IX

As above (x 400)

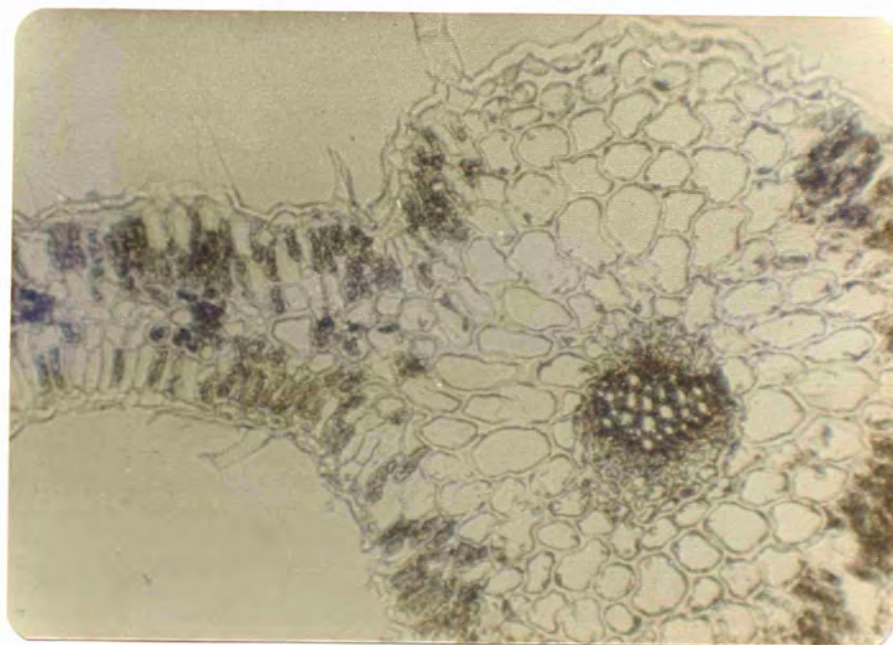

slide X

Helichrysum leptolepis

Cross-section of leaf (x 100)

Cupferron stain

Phenanthroline stained the walls of the xylem vessels and the internal structures of the epidermal cells of Helichrysum leptolepis, but no iron could be detected with this stain for the other species examined. Potassium thiocyanate also stained the same regions of Helichrysum leptolepis as did phenanthroline. Thiocyanate indicated iron in the xylem and in epidermal cells but also in the phloem for Ecboium lugardae though the staining was pale, due to lower concentrations of iron. Polycarpaea synandra, which possesses the lowest iron levels of all the species examined, showed no noticeable staining with thiocyanate.

Cupferron stained those same areas of Helichrysum leptolepis leaf which were affected by thiocyanate and phenanthroline (slide X (3/14)). Iron was conspicuously absent from the vast bulk of the tissue surrounding the central vascular canal. Again cupferron had little effect on Polycarpaea synandra tissue or, in fact, on the xylem and phloem of Ecboium lugardae.

c) Conclusions

The extraordinarily high concentration of zinc in the leaves of the sample of Crotalaria nova hollandiae, together with the sensitivity and specificity of the stain available, make the histochemical technique particularly applicable to the problem of the determination of zinc accumulation sites in the tissues of this species. The sections were stained in a 1:1 (by volume) aqueous acetone solution (Mager et al. (1953)) so that the zinc identified corresponds to the water soluble as well as the insoluble fractions given in section 2.2 b).

From the slides shown of Crotalaria nova hollandiae sections it is clear that in the leaves, sites of accumulation of zinc are the cuticle, the epidermal upper and lower cell walls and the phloem. Other cell walls and the xylem are comparatively free of the metal. The situation as regards the stem is not nearly as clear. The stems possess only about half the zinc per gram that the leaves possess and this appears to be spread throughout the stem tissue (confirmed later in microprobe work).

For Polycarphaea glabra concentrations of zinc were altogether much lower than in the Crotalaria species and this difference was reflected in the difficulty experienced in obtaining any histochemical results at all. The plant sample found, which gave an accumulation site for zinc, was hence atypical and therefore, possibly suspect. As against this an unusual plant sample was necessary to give a colour with the stain, i.e. the sample must have unusually high concentrations of the metal in its tissues. Discussion of these results for Polycarphaea glabra must thus be tempered by these considerations.

The walls of the cells surrounding the vascular canals were seen to be red on staining with the dithizone stain together with the phloem and all the cells of the epidermis.

No conclusions as to accumulation sites can be drawn for copper, the concentrations of even the most mineralized of the species being too low.

For iron the highest tissue concentrations were for Helichrysum leptolepis and Echolium lugardae, and in the leaves of both of these species, iron was detected histochemically. The vast majority of the iron in both these

species was present as a water insoluble compound and, indeed, as a dilute acid-soluble one. As expected, iron was found within the cells of the leaf blade and in the walls of the xylem of Helichrysum leptolepis leaves (Daniels et al. (1973)). For Ecbolium lugardae it was seen to be present in both these areas but also, possibly, in the phloem.

d) Discussion

The leaves of the Crotalaria species used in the analysis were not new ones as may be seen from the slides, so that it appears unlikely that the metal is arriving in the phloem from older transpiring and photosynthesizing leaves to newly growing ones. Such high concentrations of the metal in the phloem also militates against this. It is also improbable that the metal is leaving in the phloem in high concentrations, phloem in stem material possesses much lower concentrations of zinc. This accumulation at the leaf phloem should be regarded far more as a steady-state situation whereby these resevoirs have slowly built up during the life of the leaf.

The leaf is presumably transpiring, the soil solution is known to be rich in zinc, so that the metal in somewhat higher concentrations than the average are probably reaching the leaves by the normal route, i.e. in the xylem. That the xylem shows up on the slides free from high levels of zinc is testimony to the fact that there is no build-up of metal in the xylem, not that the zinc does not travel in the xylem.

Many other ions, e.g. Ca^{2+} , will be present in the transpirational stream so that cation exchange with any zinc

ion attached to the wall will occur. Hence there will be a continuous flushing of the xylem vessel walls preventing zinc build-up. The concentration of the zinc in the transpirational stream will be too low to observe as will the concentration at the xylem walls. This is as would be expected.

Zinc in relatively high concentrations (compared with that of plants on non-mineralized soil but low compared with phloem and cell wall concentrations) will arrive via the xylem at the leaf. These ions may either diffuse through the leaf or transport actively across leaf cell membranes. In a non-tolerant plant increased concentration of an ion increases the rate of active transport (Michaelis-Menten equation) and hence cells of the leaf become overwhelmed with zinc. In this plant that does not happen. Instead there is a build-up of metal at the phloem and the epidermal cell walls. There is no accumulation of metal within the leaf cells so that either the relatively high concentrations of zinc which are present in the transpirational stream do not enter the cells, or they enter, briefly, only to be actively ejected (Poole (1969)) before any large accumulation is possible. As there appears to be comparatively little metal at the cell walls, a phenomenon which would be expected if the cells precluded entry, it appears probable that the zinc enters the cells. To avoid accumulation within the cell it must be carried along via symplasmic transport where it may be ejected at the phloem along with other solutes. Zinc is comparatively slow in being carried across the phloem membrane in most species. Hence, relatively little modification of the plant is required to result in an

accumulation of the zinc at the leaf phloem. In conjunction with this it should be remembered that the phloem of the stem has relatively low concentration of the metal compared with that of the leaf. Hence, the transportation rate of zinc in the phloem is not great (Wallihan and Heyman-Herschberg (1956)). The lack of diffusion of the metal into the xylem and surrounding cell walls is, however, curious (however, see section V, 1c).

Some zinc may remain in the transpirational flow right up into the mesophyll cell walls. From here by diffusion, by guttation, by cuticular transpiration, by excretion through special glands (Ernst (1973)) or simply by contamination by wind-blown soil, accumulation of zinc in the epidermal cell walls occurs.

For Polycarpaea glabra the situation appears broadly similar to that of Agrostis tenuis roots (Turner (1970)) where metal ions arriving in comparatively high concentrations are deposited in the pectate "layer" of cell walls (section 1.2). Here, however, aerial parts of the plant are being examined, metal accumulation occurs only at the walls of specific cells, and some accumulation at the phloem also appears to occur. Further investigation of the intracellular zinc distribution for Polycarpaea glabra is given in the next section (4.3.2).

The behaviour of iron is entirely as expected, its distribution in the leaves being the same as that found in other species for normal metal levels (Daniels et al. (1973)).

2. Ultracentrifugation

This technique involves fractional centrifugation to separate the cell components after feeding the growing plant with a radioactive isotope of the element under discussion, harvesting and homogenizing the plant tissue. It is a particularly useful method for determining the intracellular distribution of zinc because of the unsuitability of this metal to the application of microautoradiography.

Ideally, plant samples should be grown from seed hydroponically for ultracentrifugation. Thus the technique could not be applied to Crotalaria nova hollandiae as no seeds were available. Seeds were available for Polycarpaea glabra and Polycarpaea synandra, but unfortunately, neither of these species can be cultivated by hydroponic methods since the roots tended to rot. Hence, these plants were cultivated in peat.

a) Method

Seeds of Polycarpaea glabra from the high zinc Dugald River lode site and of Polycarpaea synandra from the Lady Vera site (see description of sites, section 2.1) were germinated and grown for about three months in John Innes Potting Compost Number One and fed with radioactive zinc ($^{65}\text{Zn } 100 \mu\text{Cl}^{-1}$) in the nutrient solutions (Johnson et al. (1957)). The main stem was then severed and the plant parts weighed. They were then ground using a biochemical homogenizer with phosphate buffer pH 6.9. The resulting mixture was strained through cheese-cloth and the suspension introduced into the ultra-centrifuge. The speeds and times used were those of Turner (1969), i.e.

Crude debris - cheese cloth
Cell wall debris - 500g for 5 minutes
Mitochondria - 10,000g for 20 minutes
Microsomes - 100,000g for 120 minutes
Cytoplasm, cell sap - remaining solution

These conditions were preferred to those of Stocking and Ongun (1962) and Diez-Altare and Bornemisza (1967) and others because of the number and minimum overlap of fractions obtained. Stern's (1968) scheme was very similar to Turner's though the cell wall fraction was not quite as distinct.

The pellets obtained were completely drained of solution, weighed and then counted on a scintillation counter (with well phosphor for γ -radiation).

b) Results

All the results are set out in table VIII, below.

c) Conclusions

The findings for Polycarpaea glabra correlate well with extraction work (sections 3.10 and 3.11) which found that most of the zinc was present as pectate. Here it can be seen that the majority of the zinc is present in the cell-wall fraction for both stem and leaf material. The concentration readings, however, are not in such good agreement with previous work. It can be seen, for example, that the concentration of zinc in cell walls is lower than the concentration in mitochondria and microsomes. Thus, these organs should have stained red in Polycarpaea glabra samples examined by histochemical staining unless very strongly bonded

<u>Polycarpaea synandra</u> (c.p.s.)	Crude debris	Cell wall debris	Mitochondria	Mic. rosomes	Supernatant
stem	21.9	13.7	6.0	2.1	23.1
leaf	14.1	6.8	1.8	0.6	7.8
mass in g x 10 ⁻⁸					
stem	30.92	19.35	8.47	2.97	32.62
leaf	19.91	9.60	2.54	1.00	11.02
mass of plant part (g)					
stem	0.4521	0.1558	0.0111	0.0008	0.4937
leaf	0.3240	0.0136	0.0050	0.0009	0.0511
conc ⁿ /μg/g Zn					
stem	0.6848	1.2451	7.6576	37.5000	0.6603
leaf	0.6142	7.0588	5.0000	11.1110	2.1526
<u>Polycarpaea glabra</u> (c.p.s.)					
stem	25.0	24.2	8.2	2.7	14.0
leaf	21.1	19.8	8.1	1.0	7.8
mass in g x 10 ⁻⁸					
stem	35.30	34.17	11.58	3.81	19.77
leaf	29.79	27.98	11.44	1.41	11.01
mass of plant part (g)					
stem	0.5454	0.1779	0.0182	0.0011	0.5222
leaf	0.5218	0.0532	0.0101	0.0015	0.1934
conc ⁿ /μg/g Zn					
stem	0.6472	1.9207	6.3626	34.6363	0.3786
leaf	0.5709	5.2556	11.3267	9.4000	0.5692

Table VIII Readings of Intracellular Structures Containing ⁶⁵Zn

in these structures. However, the plant samples examined here are of much lower zinc concentration than the samples sectioned and stained. It is probable that as the original plant took up more and more zinc, it was increasingly deposited in the cell walls. Also, in crushing the cells, internal organs are exposed to high levels of the metal, which they do not normally experience. Thus, they give here unnaturally high readings.

There is a much higher concentration of zinc in leaf cell wall material than in stem cell wall material, confirmed in staining. All these findings for Polycarpaea glabra are consistent both with the extraction results in chapter II and the work of Turner (1969) in that most of the zinc is found present in cell wall debris and there is a much higher concentration of zinc in leaf cell walls than stem cell walls. The other major difference between results for stem and leaf material is that there is a much higher concentration of zinc in microsomes of stem material than leaf material.

For Polycarpaea synandra, more zinc was found present in the stem than in the leaf. This is perhaps surprising in that the Polycarpaea synandra collected from Australia had approximately equal concentrations of zinc in stems and leaves. Again the difference is probably due to the different conditions and length of time the plant was grown. In particular the levels of zinc in the laboratory plant were much lower than that of the natural plant. Increasing available zinc in the soil solution may result in a storage of excess metal within the leaves in a similar manner to those species examined by Dykeman and de Souza (1966).

In Polycarpaea synandra it can be seen that the majority of the zinc, particularly in the stem, is present in the supernatant fraction. This is in stark contrast to that of Polycarpaea glabra. It was noted in chapter II that Polycarpaea synandra possessed a relatively high level of water soluble zinc. These results confirm that observation.

These findings for Polycarpaea synandra are similar to those of different species by Diez-Altarea and Bornemisza (1967) and Ernst (1968) that large quantities of zinc and other heavy metals are present in the cell sap of different plant species.

3. Autoradiography

Because of its low photographic efficiency ^{65}Zn is not suitable for microautoradiography. However, this isotope may be used in large scale whole-sample autoradiography where very exact location of the tracer is not required, but rather a general overall tendency. Samples of Polycarpaea glabra were found suitable for application of this technique. Again, the species of Crotalaria could not be examined because of the inability to grow this from seed.

a) Method

(See Bonner (1950)). Seeds of Polycarpaea glabra from the high zinc Dugald River Lode were germinated and grown in John Innes Potting Compost Number 1 and fed the radioactive zinc isotope in 5ppm zinc solution in an identical manner to the samples used in ultracentrifugation (although nutrient solutions containing the tracer was used then). After approximately ten weeks the samples were harvested, freeze

dried and pasted to a piece of cardboard. The card was then placed in contact with an X-ray sensitive plate and left in a light-tight cupboard for seven weeks. The photographic plate was then developed giving a record of the zinc rich areas in the plant sample.

b) Results

The resulting photograph is shown below. It can be seen that the metal tracer is concentrated in the new leaves and at the leaf nodes. This is similar to the findings of Peterson (1969) for Agrostis tenuis.



c) Conclusions

The results, together with the wet ashings, extractions, microscopic sectioning, chromatography, electrophoresis and ultracentrifugation work on Polycarpaea glabra gives an indication of the treatment of zinc with time and with increasing concentration by the plant. Samples of the species

growing on high zinc soil in Australia were found to contain high zinc levels in their aerial tissues. Though wet ashing of leaves could not be performed because the leaves are too small to give a large enough mass with which to work, it is plain from the above that leaves possess a high concentration of zinc - particularly young leaves.

In the young Polycarpaea glabra plant zinc is accumulated in the water insoluble pectate of cell walls. As the plant ages, increasing concentrations of the metal are set down in the woody stem material. Though water-soluble, this zinc is also associated with pectates.

4. Electron probe

The general theory of this technique was described in chapter I. Unfortunately, the samples must be dried, thus interference with the normal metal distribution may occur. In addition the modern instruments have a sensitivity of only about 1000 ppm (dependent on the metal) which, although of very great use in K and Ca analyses where the concentrations may be very high, is of limited applicability to the study of heavy metals in plants. However, the zinc concentration in Crotalaria nova hollandiae samples is sufficiently high for this technique to be employed (Lauchli (1967)).

a) Method

Penetration of the primary electrons into the comparatively soft sample may be as much as half the thickness of the leaf so that preparation of a highly uniform surface is unnecessary. A section of leaf and stem of the Crotalaria sample were dried and sectioned, the stem longitudinally

rather than transversely to avoid zinc displacement. The leaf was cut to a suitable size (about 1 sq. cm.) for a surface view. The samples were glued to the base disc and coated electrically with gold metal. They were then inserted into the electron beam.

Generally, an electron accelerating voltage of 30kV was employed and a specimen current of 10^{-7} amps. The Zn K α X-ray line and Au L α lines were monitored.

b) Results

Slide 1, which is a primary electron photograph (10kV accelerating voltage) shows a cross-section of a leaf at the mid-vein. The hairy lower surface of the leaf is prominent and above this is the severed edge. The vein is clearly visible towards the left of the sample. Slide 2 shows the gold distribution in this sample and it can be seen to be evenly distributed. Thus any apparent concentration sites shown in the results for zinc are due, not to the topography of the surface, but to differential distribution of the metal in the sample. Slide 3 gives the results of Zn K α detection. Clearly, the metal is concentrated in specific areas in the plant, viz. at the cut edge rather than at the sample surface and at the veins rather than further out towards the leaf edge. There is a high concentration in the area of the phloem in the vein.

For the lower surface of the leaf, slide 4 gives a high zinc peak at the mid-rib confirming the above findings and supporting the results of histochemical staining. Slide 5 shows a similar view of the lower surface of a leaf, but with the mid-rib scraped free of hairs to highlight the vein.



Slide 1

Cross-section of leaf (x 10)

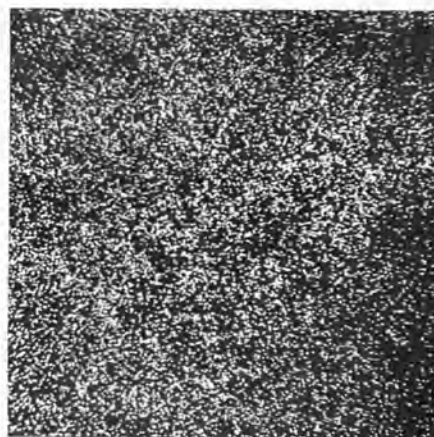

Slide 2

Au distribution in
the above (x 50)

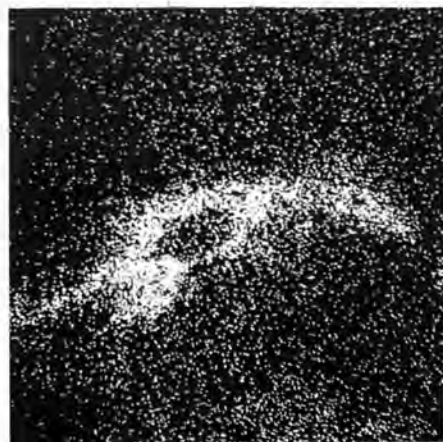

Slide 3

Zn distribution in
the above (x 50)

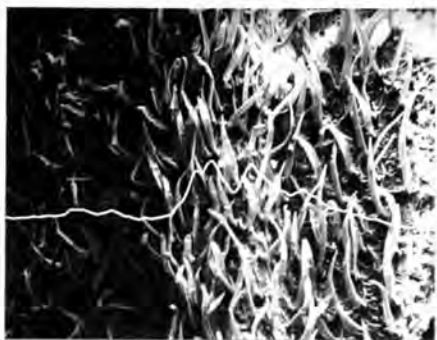

Slide 4

Underside of leaf showing
Zn peak at midrib (x 50)



Slide 5

Similar to 4 but with rib
hairs removed (x 50)



Slide 6

Zn distribution in the
above (x 60)



Slide 7

Au distribution in the
above (x 50)

Slide 8 (composite)

Crotalaria nova hollandiae - high zinc stem material



Microprobe track across stem (x 50)

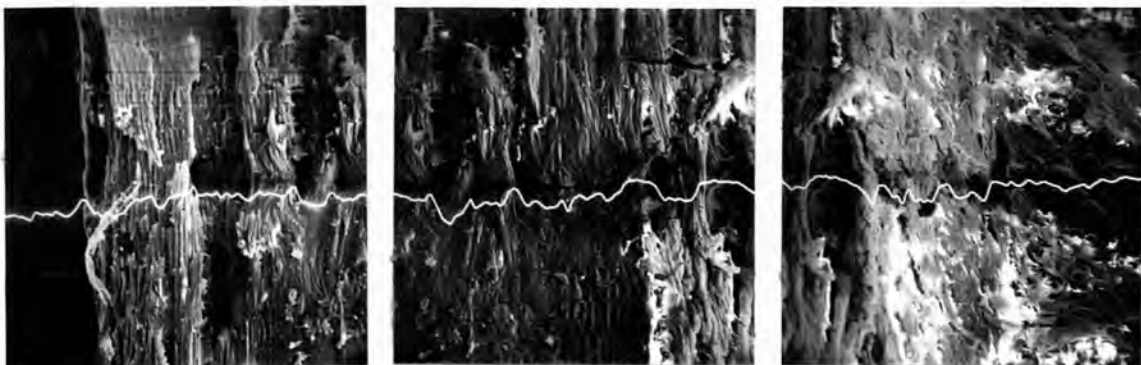

Zn distribution across stem (x120)

The track of destroyed tissue caused by the high energy electron beam can be seen. At higher metal concentrations destruction of the tissue would not occur, but high accelerating voltages are required for lower concentrations. Here again, in slide 5, the same zinc accumulation at the vein is evident and this is confirmed in slide 6. (Slide 7 gives the Au distribution). The difference in the high and low zinc concentrations illustrated by the distribution line in slide 4 has been estimated as about 7000 ppm.

For stems the metal is found to be spread throughout the sample (slide 8). The zinc concentration on a dry weight basis is only about 4500 ppm and the meter is close to its limits of detection. It was found that the conducting glue contained about this level of zinc so that the line does not decrease when the scan reaches the end of the sample.

c) Conclusions

The results confirm the findings obtained using wet ashing and histochemical techniques that zinc is found in higher concentrations in the leaf than the stem and is accumulated in the leaf veins; in stems the metal is spread throughout the tissues. As noted in section b) the results cannot be explained by the topography of the surface as gold, with which the surface was thinly coated, was seen to occur uniformly over the surface and not accumulated at the vein (slide 2). In the section on histochemical staining zinc was found at the leaf surface as well as in the phloem for this plant sample. Here it may be seen that the vast majority of the metal is found at the phloem and relatively little at the surface.

For stems the concentration is 4500 ppm and the metal is spread throughout the tissue. For leaf material the concentration is 3900 ppm and the zinc is accumulated at specific sites. Hence the microprobe technique is better suited to analysing the leaves; with stems it is operating close to its limit of detection. However, instrumentation in this technique is improving considerably. The other plant samples possessed much lower concentrations of zinc than Crotalaria stems so that for these the microprobe could not be employed at all.

Summary

In this chapter it has been possible to obtain a clear view of the principle types of bonding and accumulation sites in the two major plant species under investigation. As a result a picture has emerged of two different methods of zinc treatment in the plants. Polycarpaea glabra takes in high levels of zinc and accumulates them in the pectate layers of the cell walls of specific cells in the leaves and leaf nodes of the stem. Crotalaria nova hollandiae takes in massive concentrations of zinc and deposits it mainly in the phloem and epithelium cell walls of leaves. This accumulated metal is very soluble in hot water, unlike the zinc in Polycarpaea glabra.

Discussion

A number of examples of the storage of heavy metals in cell walls have been recorded. Diez-Altare and Burroughs (1961) and Diez-Altare and Bournemisza (1967) found that for corn seedlings grown at normal nutrient levels, up to

44% of the total zinc was present in cell walls. Cartwright (1966) found 64% of the total copper in subterranean clover nodules located in the cell walls and Turner (1969), Turner and Marshall (1971), Peterson (1969) and many others have found a high proportion of metal present in the cell wall fraction, and indeed in pectates. Most of the work has been on roots.

Examples of water-soluble metal accumulation at the phloem are far fewer in number. Smith (1953) reported the phenomenon in citrus roots and Clarke (1976) found high concentrations of nickel accumulated in the phloem of Hybanthus floribundus leaves.

The only other method of accumulation of high metal levels appears to be by complexation with amino acids, peptides, polypeptides or proteins and storage in the cell sap (Reilly et al. (1970), Cannon (1960), Arakatsu and Ashida (1956), and Mills (1954)).

In the following chapter further examination of the water insoluble fraction is carried out.

Chapter V

Further Investigation of Water Insoluble Metal Compounds

5.1 Introduction

The work performed here on Polycarpaea glabra has resulted in two clear conclusions; firstly, there are very real physiological differences between plants grown from seeds derived from high zinc containing samples and those from seeds from low zinc-containing samples viz. the treatment of zinc in their tissues. The second conclusion is that for high zinc containing plants and their offspring, the metal is accumulated in the pectate layer of leaf cell walls. This second conclusion is similar to that of Bradshaw et al. (1965), Antonovics et al. (1971) and others for copper and zinc in roots of Agrostis tenuis. The explanation that has been suggested for this phenomenon is that the metal in the soil solution or xylem flow is specifically filtered out by the cell wall so that the cells experience only comparatively little of the toxic metal. Non-tolerant plants do not possess cell walls with this propensity and hence higher concentrations enter the cells. This mechanism rests on three factors:-

- 1) within the roots the metal was present in the pectate layer of the cell walls rather than in the soluble fraction
- 2) the root: shoot metal ratios for this type of tolerance are high for tolerant plants and relatively low for non-tolerant plants and
- 3) zinc was known to be taken up passively and the cell

wall fraction was implicated.

Now these three points are well established but the third requires examination.

When a higher plant is exposed to a radioactive tracer in its nutrient solution, or indeed to any ion in soil or nutrient solution, the ion will diffuse into the outer space of the root, i.e. the cell walls of the root hairs, epidermal and cortical cells and intercellular spaces. From this position of intimate contact with root cells, it may then be either adsorbed onto the pectin layer of the cell walls by a passive process or absorbed actively by a carrier across the plasmalemma and into the cytoplasm. Washing with water will not remove metal taken into the inner space (within the plasmalemma) or from the Donnan Free Space. Hence, though Findenegg and Broda (1965) were correct in stating that the uptake of zinc by plants was a passive process, this did not apply to the actual taking of ions into the cells. This latter transport was very much an active process (Schmidt et al. (1965)). Thus, because carriage into the symplasm is an active process, most of the metal present in the aerial parts of plants has been taken into the plant via an active mechanism. This is not the case with metal in roots, most of which is present by passive diffusion and cation exchange.

The logic in the belief of passive uptake of zinc leads to the only possible conclusion as regards tolerance, i.e. that the mechanism of tolerance is also the accumulation site - the cell wall. Thus the arrangement of pectins and polygalacturonic acids of the cell walls of tolerant and non-tolerant plants must be different, the cell walls of

tolerant plants containing many specific Zn cation exchange sites.

In view of the fact that high Zn Polycarpaea glabra stores zinc by the same mechanism, in the same compound and at the same site, questions as to the specificity of the site are relevant. A comparison of samples from seeds from the high zinc area and low zinc area may be made as there is a difference in tolerance to and treatment of zinc in the samples.

For Crotalaria nova hollandiae the ability to take up and tolerate high levels of metal in its tissues appears to be brought about by an entirely different mechanism to that of the species described above. Zinc has been found mainly as water soluble compounds, particularly in the leaves. At first sight the mechanism appears similar to those demonstrated by Ernst (1968) and Reilly et al. (1970). Ernst found zinc present concentrated in the cell sap of certain plants, presumably restricted from metabolic interference, and indeed transport, by the tonoplast. However, in the species of Crotalaria examined it has been observed that the zinc accumulates at cell walls and at the phloem (i.e. not within the vacuoles of cells). Reilly found that most of the copper present in high copper containing Becium homblei was also soluble in water; the metal was found as very stable, non-toxic, amino-acid complexes. However, this does not appear to be the case here. Crotalaria nova hollandiae species is dissimilar to most other high metal containing species examined.

For both species then the question of specificity of the water insoluble zinc site is of interest. An experiment was first devised to find what proportion of zinc and in

what water insoluble fractions was the metal exchangeable with Ca^{2+} ions. Calcium ions were used in that they are good ion exchangers and are commonly used in washing samples, e.g. roots of plants in hydroponic studies, to remove ions in the Donnan Free Space.

a) Method

After drying, leaf and stem material of Crotalaria nova hollandiae and stem material of high zinc Polycarpaea glabra were separately ground finely on the ball mill. Approximately 1g of this material was weighed out into a 1 litre conical flask and extracted with cold aqueous ethanol and a large volume (500 cm³) boiling water. The water extraction was repeated and the mixture left to separate out. The solution was decanted off and 200 cm³ 0.00027M Ca^{2+} ion solution was added and the flask shaken for 24 hours. After separation a second portion was added and the flask shaken again. The separated residue was then taken through the Peterson pronase extraction scheme. The solutions after extraction were removed and, in the usual manner, evaporated to dryness, wet ashed, diluted and read on the atomic absorption spectrophotometer.

b) Results

The readings of the various extracts are given in tables IX, X and XI.

c) Conclusion

It may be seen from chapter III that approximately 40% of the total zinc in Crotalaria nova hollandiae stem

Extraction 1 (these figures from chapter IV)

Zinc (ppm)

	ether	30% ethanol	H ₂ O	H ⁺	residue	total	wet ashing
stem	0	2	2921	1438	494	4855	4747
leaf	69	275	6534	2410	121	9409	8974

Extraction 2 (readings from chapter IV) Table IX.

Zinc. Plant stem. (ppm)

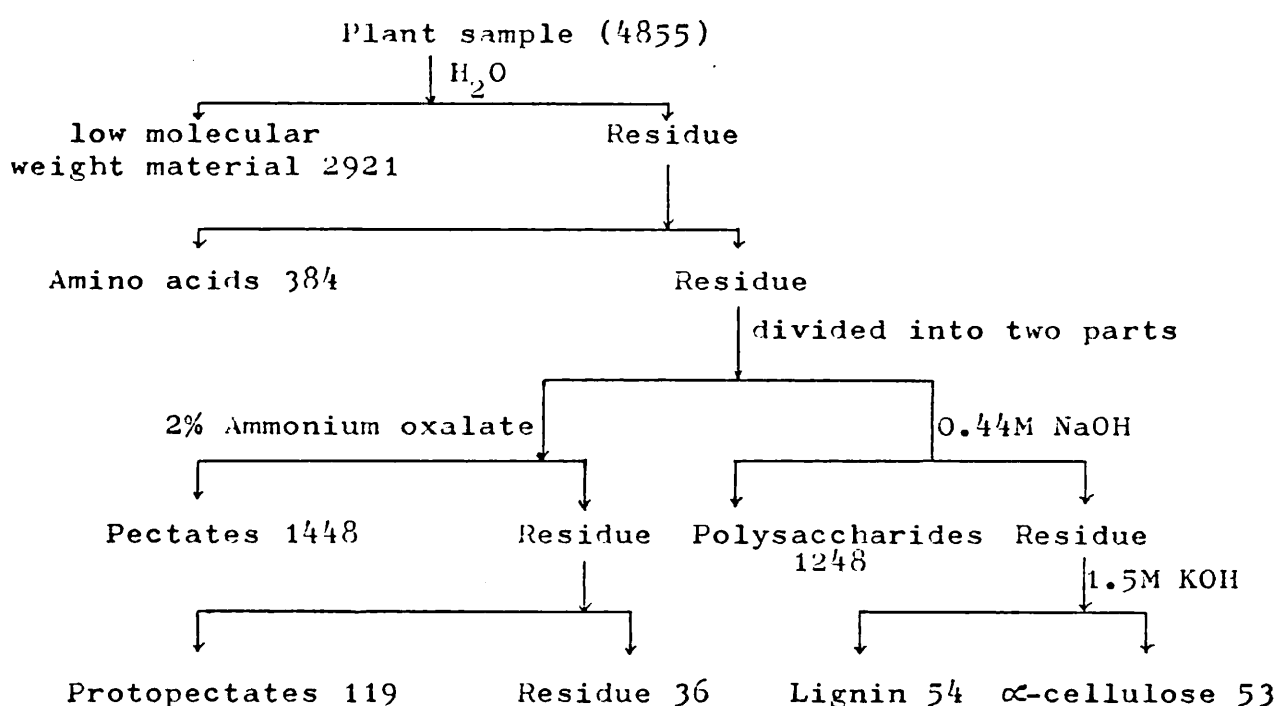

Zinc. Plant leaf. (ppm)

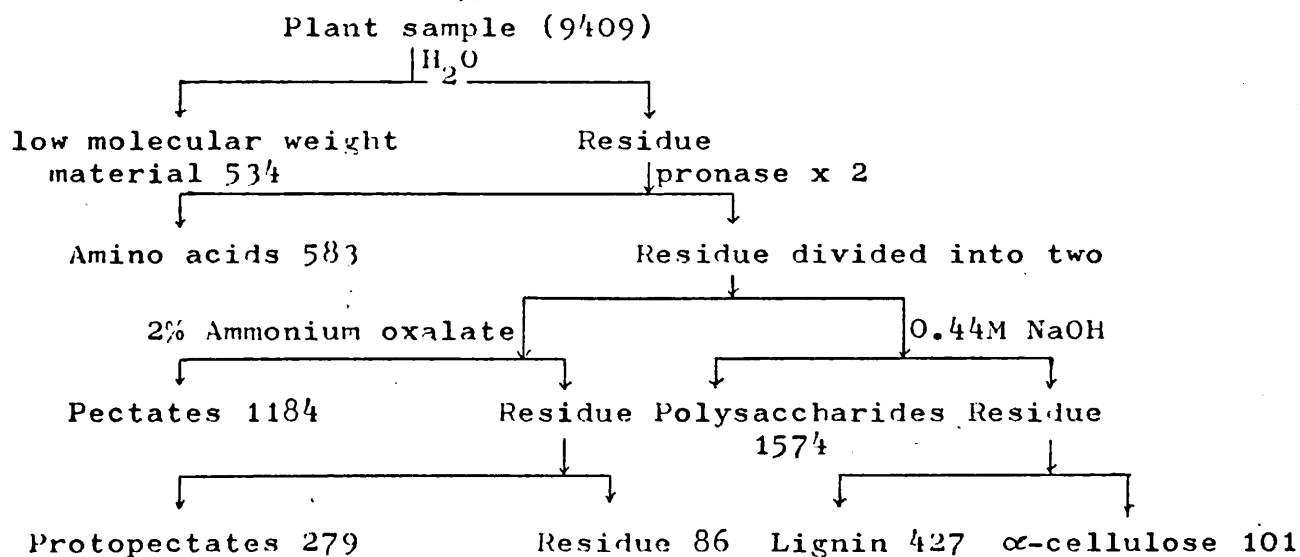

Extraction 3 (Table X)

Plant stem. Ca^{2+} added after aqueous extraction (ppm)

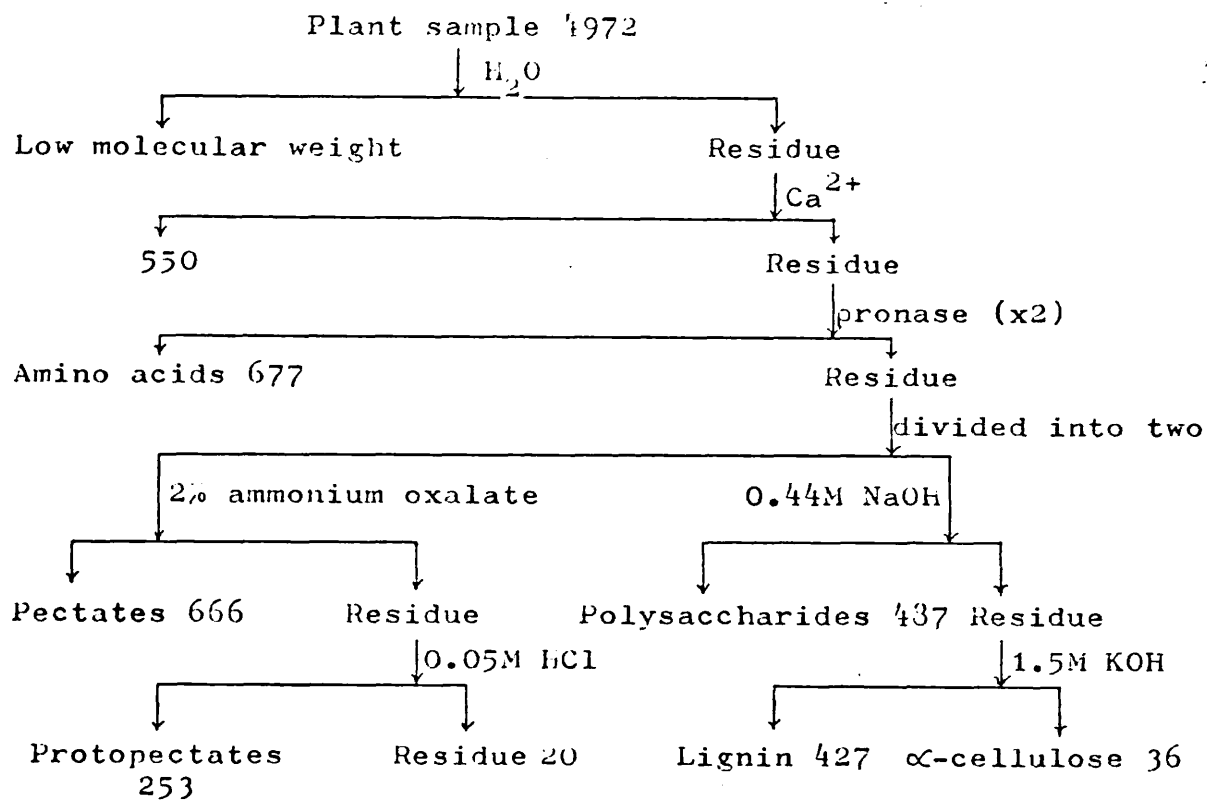

Plant leaf. Ca^{2+} added after aqueous extraction (ppm)

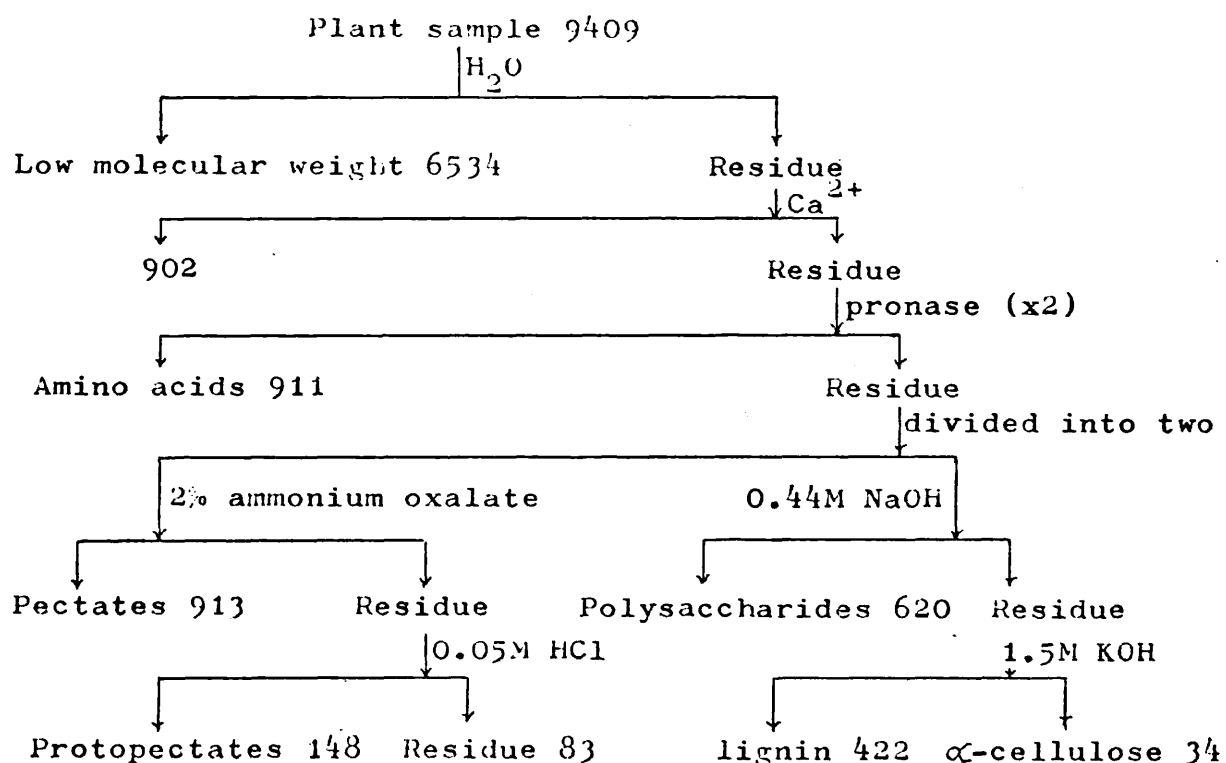
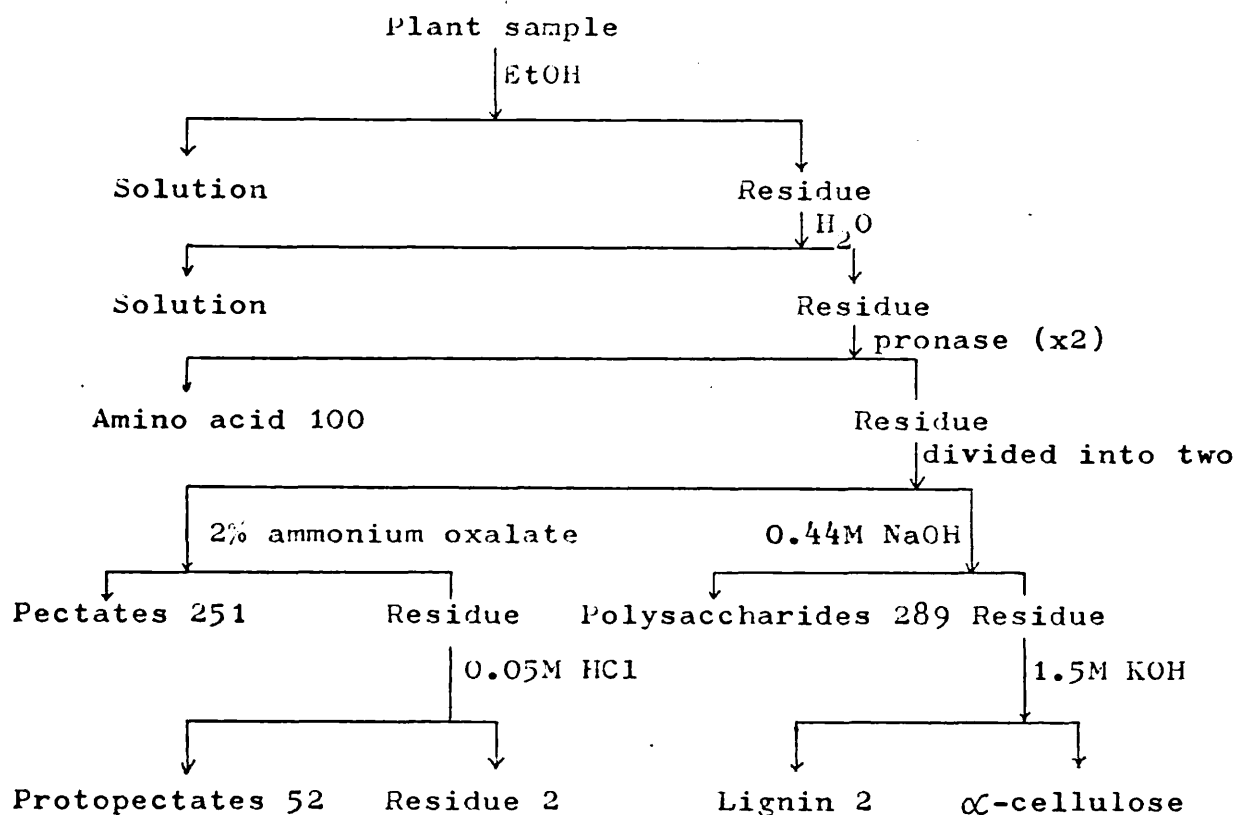
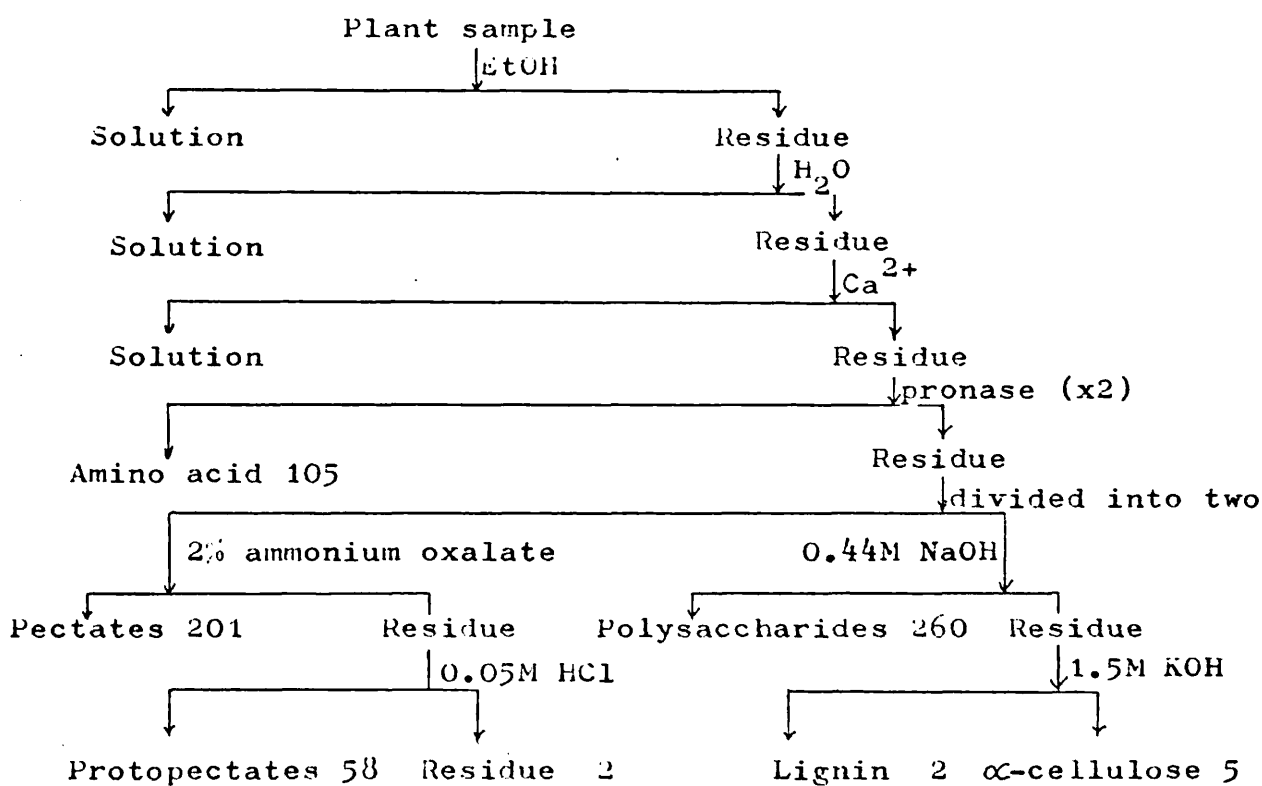

Table XI,

Polycarpaea glabra stem (from chapter IV) (ppm)Addition of Ca²⁺ solution after aqueous extraction (ppm)

material and approximately 25% of the total zinc present in leaf material is insoluble in boiling water. The zinc species present in this solvent was indistinguishable from aqueous Zn^{2+} ion, both chromatographically and electrophoretically.

It is clear that of the insoluble zinc remaining the large majority is associated with pectates. The next largest fraction in both leaf and stem is that associated with amino acids, peptides and proteins, though this is considerably lower than the pectates. Zinc is not associated to any great extent with protopectates, celluloses and lignin, though some bonding does occur.

It is found from results given in table XII that after normal extractions of the plant material with boiling water, addition of relatively high concentrations of Ca^{2+} ions release further quantities of zinc. For stem material Ca^{2+} extracts apparently only from the pectate fraction (800 ppm of the original pectate concentration of approximately 1450). Over one quarter of the zinc released from the pectate layer appears to be recaptured by other fractions, the remainder is left in solution.

For leaf material, again zinc ions are released from the pectate fraction in high concentrations (almost 1000 ppm of 1880). Here, however, protopectates also lose zinc on addition of Ca^{2+} and no other fraction, other than the protein one, appears to gain zinc.

Now, assuming the chemical compounds behave similarly in stem and leaf, and noting the large difference in zinc concentrations between the two, an attractive explanation of the results may be suggested as follows. If Crotalaria nova hollandiae restricts entry of zinc into its cells and

accumulates most of the insoluble zinc as pectate in cell and phloem walls, breakdown of the walls and membranes and extraction with Ca^{2+} will release Zn^{2+} ions by cation exchange (a property for which pectates are renowned). Other compounds of the cell and cell wall will then attract the zinc (i.e. there will be a general levelling out of zinc concentrations amongst the various chemical structures. However, in the leaf the zinc levels are much higher than in the stem, thus when release of zinc by calcium occurs the cellulose, protopectate etc., far from absorbing more zinc, will release it by exchange with Ca^{2+} ions. The only chemical structures in the leaf material to absorb any zinc released is the protein, a considerable proportion of which was protected from high concentrations of zinc by the cell membrane before the material was ground. The stem compounds probably also lose zinc by exchange, but gain more zinc due to their comparatively low levels of the metal.

From the sections of stem and leaf it can be seen that zinc accumulates in high concentrations in the epidermis cell wall, the cuticle and particularly in the phloem. This is consistent with results found for nickel in Hibanthus floribundus (Clarke (1976)). Even though zinc is known to travel in the phloem in certain circumstances, e.g. from old leaves to young growth, it seems unlikely that the zinc is actually travelling in the phloem. Transport of ions normally occurs at relatively low concentrations compared with that of accumulation sites. Hence, the phloem appears to be a repository of a significant fraction of the total zinc present, particularly in the leaf. A more satisfactory explanation of these high concentrations at the phloem is

that the phloem membrane restricts entry, as it does of Ca^{2+} ions. Thus large concentrations of zinc build up at the membrane and the metal is relatively immobile in the plant. In support of this, it has been noted (chapter IV) that, though there are high zinc concentrations in the phloem of leaves of Crotalaria nova hollandiae, the phloem of stems contain much lower levels of the metal. This is consistent with the theory of comparative immobility of the metal at the phloem.

There are two possible mechanisms by which zinc may arrive at the phloem walls from the xylem, i.e. by diffusion outside the cells or by transport within the cells. Simple diffusion is unlikely because for the sample zinc accumulates against a concentration gradient. Thus Zn^{2+} ions probably travel within the cells between specifically zinc impenetrable membranes to a Zn^{2+} efflux carrier, which deposits the metal at the phloem (see Poole (1969) and section 1.9).

Addition of dilute acid, Cu^{2+} ions and Ca^{2+} ions all appear to remove much of the zinc. (Unfortunately, copper is found to interfere with the stain, giving a brown colouration which completely masks the red colour due to zinc). If the zinc at the phloem is present as ions adsorbed or a kinetically labile complex, addition of Ca^{2+} ions could certainly exchange with the zinc. It has already been observed (section 5.1 b) that some of the zinc in the pectates of cell walls is exchangeable with Ca^{2+} ions.

It appears probable that in the extractions of Crotalaria nova hollandiae material with water, comparatively high concentrations of Ca^{2+} ions are released, which then

exchange with Zn^{2+} ions bonded at the phloem. This results in relatively high concentrations of Zn^{2+} ions in solution (confirmed by paper chromatography and electrophoresis) and explains the distinct localization of the metal at the phloem, i.e. its lack of diffusion to nearby cell walls.

The extraction of Polycarpaea glabra by this scheme is rather less reproducible than the Crotalaria nova hollandiae sample, primarily because it does not possess such high concentrations of zinc. However, the results show a general loss of zinc from pectate only, and no real gains. The degree of zinc loss is very much less than for the previous species.

The experiment as a whole yielded much information about various fractions in relation to their bonding with zinc, but relatively little as regards specificity of accumulation site in Polycarpaea glabra. In chapter IV samples from the high zinc area have been found to treat zinc differently from samples from the low zinc areas. Also there is a difference in sensitivity to zinc toxicity in the two samples. Thus, a comparison of the metal specificity of the cell walls of the samples would be instructive.

For the Crotalaria species it is evident that the vast majority of the metal is present in non-specific sites. The majority of the zinc is soluble in water, apparently present as Zn^{2+} ions (see above) and most of the water insoluble pectate zinc is exchangeable with Ca^{2+} ions.

5.2 Further investigation of cell wall sites in the two species

Approximately 90% of the mass of dried young leaf and stem is cell wall material. If the cell walls possess the ability to remove specifically zinc from the xylem solution it should be possible to demonstrate the phenomenon by selective absorption of zinc from a mixture of ions, or to observe a difference between the absorbance for a tolerant and a non-tolerant plant.

All the cation exchangeable zinc must be removed initially so that release of zinc does not occur to interfere with the results. The simplest method is to pack the material into chromatography columns and examine the concentrations of solutions of ions emerging from the bottom. In comparisons of absorptions, great care must be taken that identical masses of material are used and packed in very similar condition in the columns. The ion concentrations of the solution introduced at the top of the column must be chosen after much experimentation and deliberation so that they are concentrated enough to avoid a prolonged period of absorption and exchange and yet dilute enough to prevent any swamping of a possible absorption bias that might exist.

a) Method

Approximately 5g of aqueous extracted high and low zinc Polycarpaea glabra stem material and Crotalaria nova hollandiae leaf material was shaken with a 50 ppm solution of Ca^{2+} ions, 8 hours a day for four days, changing the solution each day. The material was packed separately in

half-inch diameter chromatography columns and calcium solution run through at a rate of 0.2 cm^3 per minute. When the Ca^{2+} ion solution was run off there was no red colour observed on spotting onto dry dithizone paper. Hence, very little Ca^{2+} exchangeable zinc was present in the material.

An equimolar $\text{Cu}^{2+}/\text{Zn}^{2+}$ solution (0.00027M) was added at the top of the column and 1 cm^3 samples were collected at the bottom. Every cubic centimetre of solution which emerged was collected. The samples of solution were then analysed for copper and zinc on the atomic absorption spectrophotometer.

b) Results

The readings of the metal concentrations of each 1 cm^3 of solution emerging from the columns are given in table XII for each sample.

c) Conclusion

As expected, because pectates have a greater affinity for Cu^{2+} than Zn^{2+} ions (Schweiger (1966)), the zinc emerged from the column first in both species. The separation of the two ions was remarkably good, marginally better in Crotalaria nova hollandiae than in either of the Polycarpaea glabra samples. Very little difference in metal absorption was observed for high and low zinc Polycarpaea glabra samples.

d) Discussion

For Crotalaria nova hollandiae and, indeed, all the samples, zinc emerged from the column before copper. In the

Solution	<u>Crotalaria</u> <u>nova hollandiae</u> (leaf) (ppm)		<u>Polycarpaea</u> <u>glabra</u> (high zinc) (ppm)		<u>Polycarpaea</u> <u>glabra</u> (low zinc) (ppm)	
	Zn	Cu	Zn	Cu	Zn	Cu
1	0.15	0.20	0.15	0.30	0.15	0.20
2	0.25	0.20	0.15	0.30	0.15	0.20
3	0.25	0.20	0.15	0.20	0.15	0.20
4	0.15	0.20	0.15	0.20	0.15	0.20
5	0.15	0.20	0.15	0.20	0.15	0.20
6	0.15	0.20	0.15	0.20	0.15	0.20
7	0.70	0.20	0.20	0.20	0.15	0.20
8	10.00	0.20	9.00	0.20	10.00	0.20
9	15.50	0.20	14.50	8.00	15.00	11.00
10	17.50	10.00	17.50	13.50	17.50	15.00
11	17.50	14.00	17.50	17.00	17.50	17.00
12	17.50	17.00				
13	15.50	17.00				

Table XII Zinc and Copper Concentrations
in Preferential Absorption Experiment

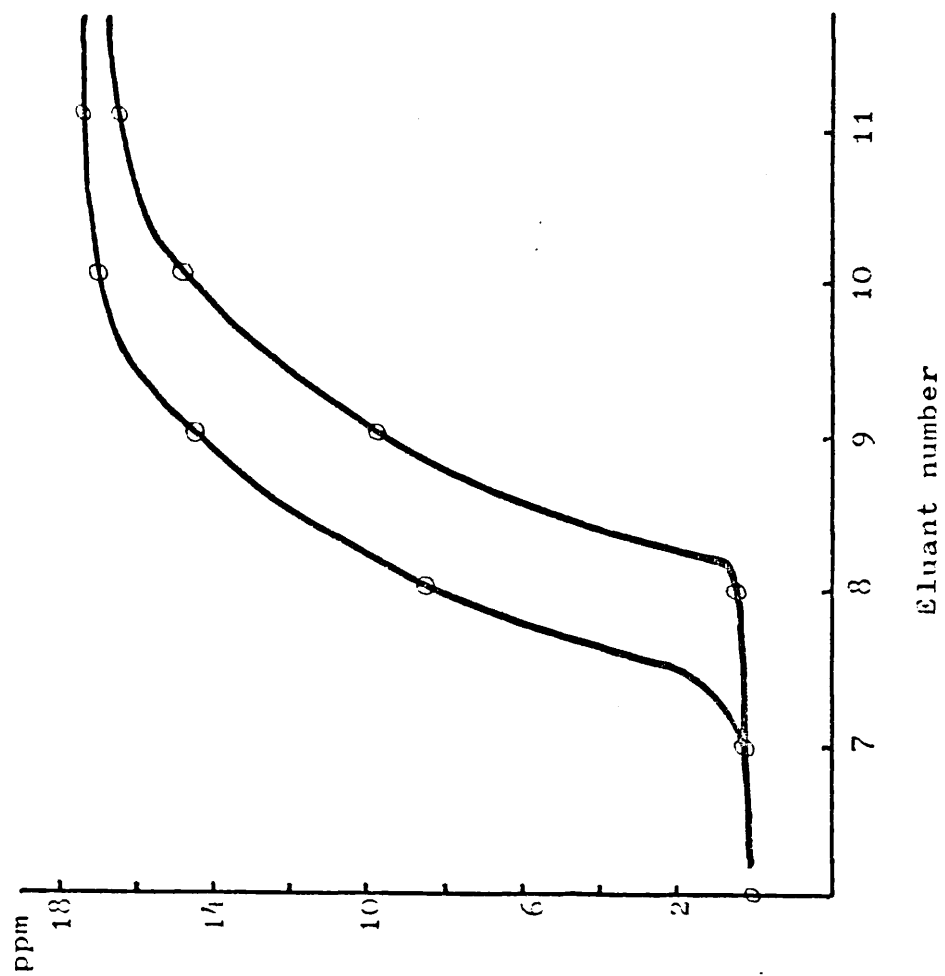
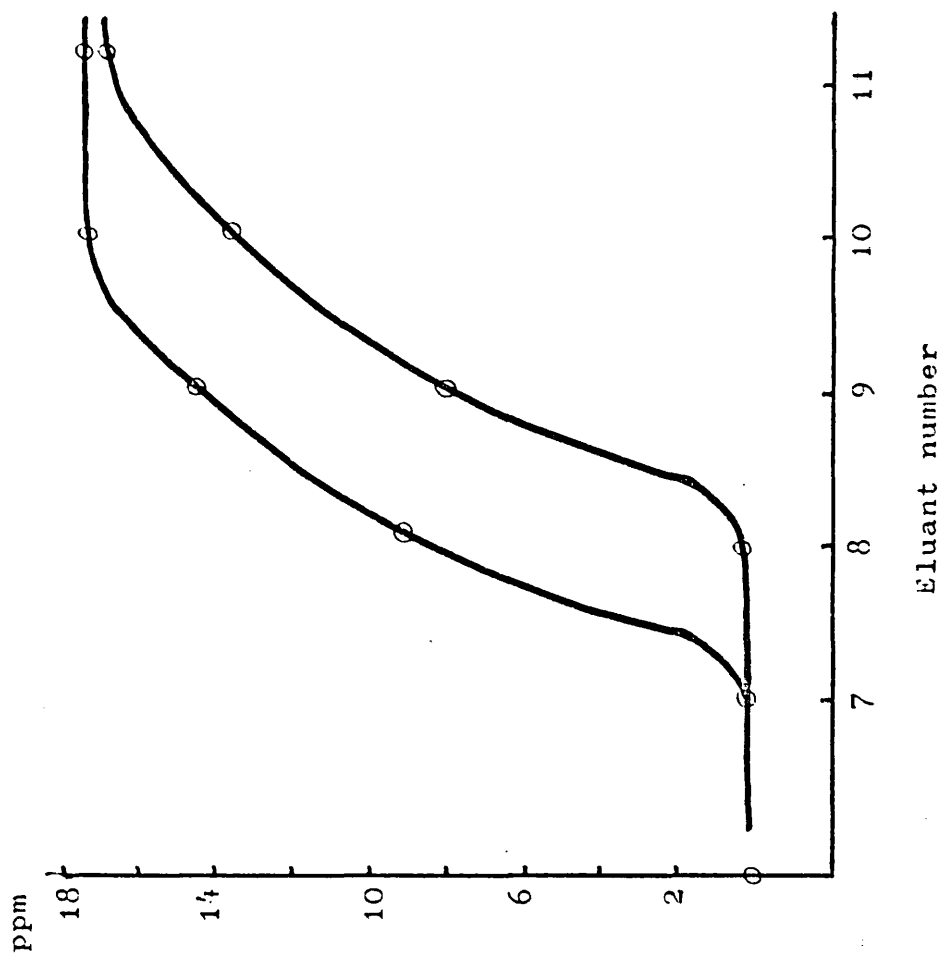
Polycarpaea glabra - low zincPolycarpaea glabra - high zinc

Crotalaria nova hollandiae - preferential absorption

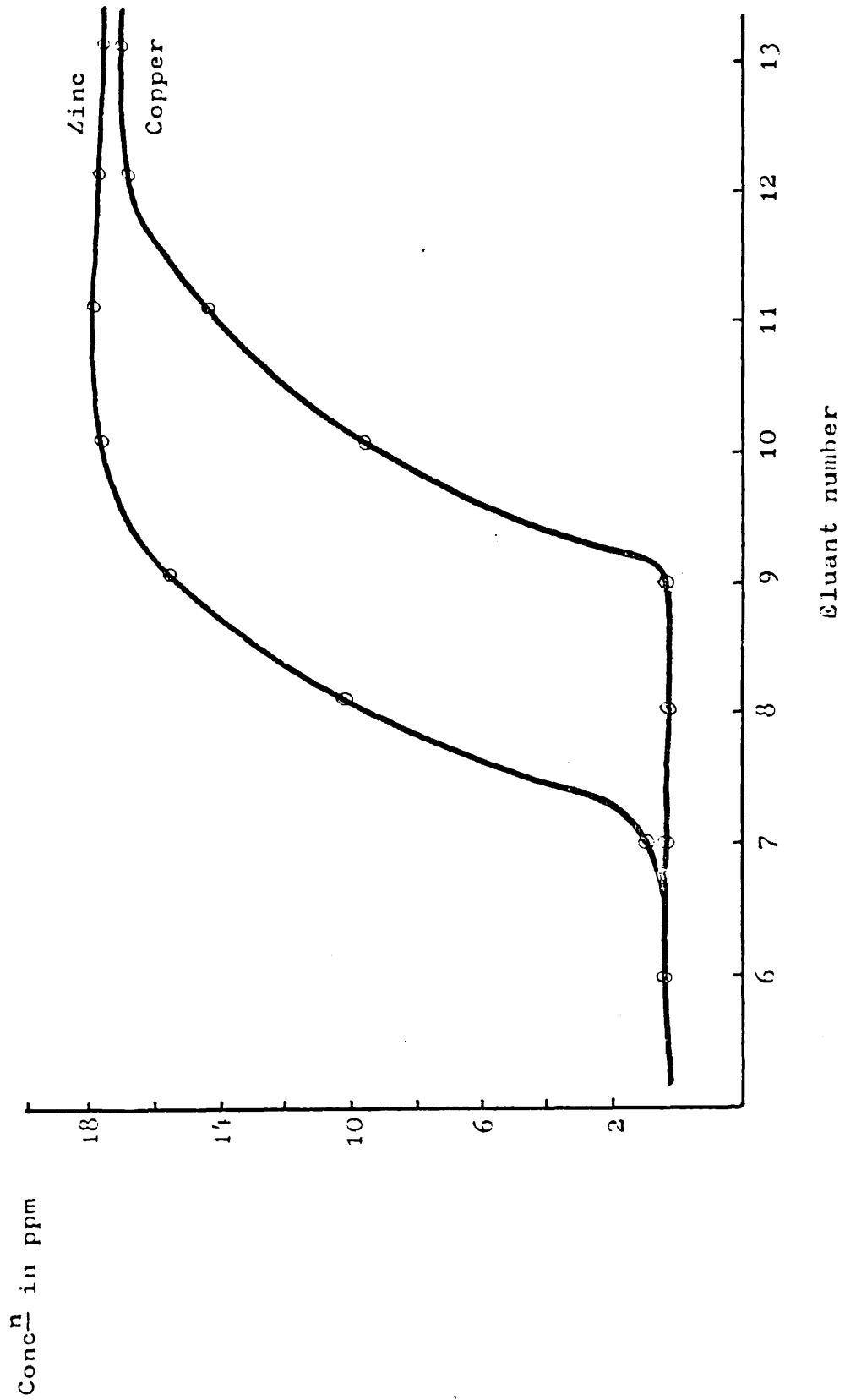

absence of non-mineralized Crotalaria material no definite conclusions as regards increased zinc absorbance can be drawn. For Polycarpaea glabra, however, comparison can be made and it is clear that there is very little difference in behaviour between the two samples as regards preferential absorption of metals. Thus, in this species at least, ability to withstand high concentrations of zinc in tissue is not primarily due to cell wall material "sieving out" zinc in preference to other metals.

A further experiment was performed in an attempt to find some preference for zinc in the cell wall material of high zinc Polycarpaea glabra over that of low zinc Polycarpaea glabra. The technique employed was that of Turner (1970) involving separation of cell walls from other material by ultracentrifugation (see chapter IV) and addition of radioactive tracer. Thus, the different absorption capacities of zinc may be determined for the Polycarpaea glabra samples.

5.3 Determination of difference in zinc absorption capacity in two samples of Polycarpaea glabra

a) Background

It has been claimed (Ernst (1965)) that for some species heavy metal toxicity is resisted by an increased specific metal absorption onto cell walls. This postulation is tested here for the case of Polycarpaea glabra using the method and conditions of Turner and Marshall (1972). Fresh cell wall material is separated by ultracentrifugation, treated with ^{65}Zn and counted. The concentrations of zinc in the cell walls were compared.

b) Method

Seeds from the high metal and low metal areas were germinated and grown in John Innes Potting Compost No. 1 and fed with Epstein (1972) one quarter strength nutrient solution. After 11 weeks the aerial parts of the plants were harvested and homogenized. The cell debris was removed by filtration through cheesecloth and the remaining slurry centrifuged down. The supernatant was drained off and the residue divided into two parts and weighed in 10 ml. tubes. 1 ml. of an $800 \text{ uCl}^{-1} \text{ }^{65}\text{Zn}$ solution was added and the residue shaken for 2 hours and recentrifuged. The residue was carefully washed with Ca^{2+} solution and 1 ml. concentrated nitric acid added. After digestion the solutions were read using the scintillation counter.

c) Results

	high metal glabra		low metal glabra	
mass of cell wall (g)	0.3138	0.2482	0.2092	0.2233
raw readings (c.p.s.)	2793	2132	1820	2006
mass in ($\text{g} \times 10^{-10}$)	4198	3010	2570	2832
concentration ($\text{g} \times 10^{-10} \text{ g}^{-1}$)	13375	12127	12284	12683

d) Conclusions

Certainly on average the high metal glabra plants adsorb more zinc than the low metal plants. However, the difference is relatively small and does not appear to be sufficient to protect the plant from zinc toxicity. However, many more comparisons of this type should be attempted and

a statistical analysis applied before a confident conclusion can be presented.

e) Discussion

The results of the two experiments carried out to investigate the specificity of the accumulation site do not, to any degree, support the assertion that the cell walls of plant cells possess the high degree of specificity exhibited in tolerance. The plants themselves are certainly susceptible to copper toxicity at only moderately elevated concentrations and they can be identified by their differing resistances to zinc toxicity. A specificity between copper and zinc is thus manifested in the sensitivity of the plants to these metals. This degree of specificity is not evident in the respective adsorption properties of their cell walls.

Summary

The work performed here developed from a comparatively broad preliminary investigation involving four or five metals into, principally, a comparison of the treatment of high concentrations of zinc in two plant species originating from the same site. It was found that in a number of respects, this treatment of zinc differed significantly in the two samples.

Polycarpaea glabra and Crotalaria nova hollandiae, found growing on the same Australian zinc site, were found (chapter II) to possess high concentrations of the metal in their aerial tissues, levels which would be considered toxic in most other plants. Other species, e.g. Polycarpaea synandra, were also found to be highly mineralized but, for various practical reasons, were discarded from further investigation.

It was discovered (section 2.2) that not only was the majority of metal bonded differently in the two species, but that different zinc compounds existed within the tissues of a single plant sample. For green leaf and stem material most of the zinc was insoluble in water, in Crotalaria nova hollandiae the majority of the zinc in leaf and stem material was soluble in water. It was also found that the woody stem of Polycarpaea glabra was more highly mineralized and a higher proportion of the metal water soluble than in green stem material.

The soluble fractions of the two species were examined first and with certain theoretical reservations, the soluble zinc in Crotalaria nova hollandiae proved to be the Zn^{2+} (aq) ion. For soluble zinc compounds in Polycarpaea glabra, chromatographic and electrophoretic examinations revealed

two distinct zinc complexes present; one predominating in stem and leaf material and one in the flowers. A whole range of chromatographic systems were attempted to find one capable of separating these comparatively unstable complexes of zinc. No Zn^{2+} (aq) ions were found in this species. The complex in the flowers was relatively unstable to other metals and ligands, was soluble in ethanol and was uncharged. The complex in stem material was more stable and was identified as a zinc pectinate. It was felt that none of these three soluble zinc species was capable in itself of providing protection to the plant from the metal's toxic effects. Confirmation of the identity of the soluble zinc complex of Polycarpaea glabra stem material was effected (sections 3.10 and 3.11) using the separation techniques of Levitt (1951) and Sevag et al. (1938).

For Polycarpaea glabra in particular, investigation of the insoluble zinc complex was important but both species were examined (section 4.1) using an extraction scheme which included a proteolytic enzymic digestion. In both high zinc species the majority of the insoluble metal appeared to be present in the polysaccharide-pectin fraction. In a Polycarpaea glabra sample from a low zinc site a surprisingly low proportion of zinc was present as insoluble pectate, more occurred as protein. This low zinc Polycarpaea glabra sample was less resistant to zinc toxicity than the sample from a high metal area, but was similar in susceptibility to copper toxicity.

Sectioning of the plant parts found most zinc present in Polycarpaea glabra in the walls of specific cells and in Crotalaria nova hollandiae in epidermal cell walls and

particularly the phloem. The presence of zinc in Polycarpaea glabra cell walls was confirmed by ultracentrifugation (section 4.3 2)) and its difference with low zinc Polycarpaea synandra noted. For Polycarpaea glabra use of whole sample autoradiography revealed zinc present in new leaves and at leaf nodes. The electron microprobe confirms accumulation of zinc in Crotalaria nova hollandiae in the phloem of leaves and indicates only relatively low concentration in the epidermal cell walls.

The zinc extraction schemes reported in section 5.1 reveal that most of the zinc in Polycarpaea glabra stems was firmly held in the pectate fraction and was not easily replaced by Ca^{2+} ions. This suggests a large degree of complex formation with the polysaccharide. Crotalaria nova hollandiae material on the other hand binds the metal very weakly, the majority of zinc in both stem and leaf being soluble in water, and the majority of insoluble metal was easily exchanged with Ca^{2+} ions. This phenomenon had been observed for the species in the section on histochemistry.

It has been asserted that pectin of cell walls has the ability to filter out zinc rather than, say, copper as a means of preventing high zinc concentrations disrupting cell metabolism. In view of the bonding in Polycarpaea glabra the plant was examined in an attempt to observe this phenomenon. In section 5.2 the well known ability of cell wall material and, indeed, pectin to absorb copper rather than zinc was observed (Lyotropic series) but little difference in ability to absorb zinc was seen in high zinc and low zinc Polycarpaea glabra.

The capacity for zinc of cell wall material for high and low zinc plants was tested but found to be almost identical. If tolerance can be bestowed on a plant by the method of pectin zinc affinity it is almost certainly not present in this species. In fact, this suggested ability of pectin in cell walls to absorb specific metals as a primary mechanism of tolerance was questioned (section 5.1).

Certainly for the two species examined here a more probable mechanism is that of restriction of entry by various plasma membranes. This may be brought about either by low carrying capacity of specific carriers or by the presence of specific efflux carriers. For Polycarpaea glabra most cells will permit large scale Zn influx into the cytoplasm, but not presumably into the nucleus, ribosomes or mitochondria. Certain cells, however, will not permit prolonged entry into the cytoplasm and build-up of metal occurs in their cell walls. For Crotalaria the metal appears to be carried rapidly to the phloem where absorption and transport is comparatively slow and metal accumulation therefore occurs. In comparison relatively little zinc accumulates in other cell walls.

If these conclusions are largely correct, an obvious question still to be resolved is by what mechanism the metal is allowed only limited entry by the plasma membranes. It is, unfortunately, an extremely difficult problem to answer or even to examine. A somewhat easier question for future research is in what chemical form the metal is transported in the xylem (Stewart (1963)). This is of great general interest but important in that treatment of the metal may well differ for different zinc complexes. Collection of the

stem exudate containing radioactive tracer and chromatographic analysis using various systems should result in characterization of the complex. Another valuable field of investigation lies in further examination of the zinc complexes of Polycarpaea glabra - particularly in pectinate. Its structure, properties and overall stability constant would be of great interest particularly in assessing its effectiveness in rendering the metal passive. Viscosity measurements on the complex similar to those of Schweiger (1966) would be suitable.

Finally, two different methods of zinc tolerance and accumulation have been demonstrated here. Ernst (1968) demonstrated another method, exhibited by Silene cucubalus, which involved accumulation of the metal in the vacuoles. Are these three the only methods for zinc? An examination of a wide range of different zinc tolerant species may result in the discovery of other zinc tolerance mechanisms.

Appendix1. Atomic absorption spectrophotometer calibration

When the concentrations of a number of elements were to be determined or where a comparison of elemental concentrations were required rather than an absolute value, the method of standards was used. Here, duplicate wet ashed and suitably diluted samples are compared directly with a series of standards; the standards possessing the same proportion of concentrated nitric acid in water as the samples. A calibration curve (see below) is set up of meter reading versus concentrations for the standards and the concentrations of the samples may be determined from this. Hence, the concentration of the metal in the original sample (before dilution) may be calculated.

The method of standard addition was also employed for comparison and, for example, in the Sevag extraction in Chapter III. Here, a large volume of sample solution is read on the spectrophotometer and a small volume of a known high concentration zinc solution added. The solution is now re-read and the procedure repeated at least five times. The resulting curve of reading versus zinc concentration added is shown below and the intersect of the plot with the x-axis gives the original concentration of the sample solution.

P.T.O.

The lamps employed, the currents, slit widths and other conditions are shown below.

Element	lamp current	wavelength	slit width	flame	1'min ⁻¹ approx.	
					air	C ₂ H ₂
Zn	8mA	213.9nm	120nm	air/acetylene	7	1.5
Cu	6mA	324.8nm	15nm	"	7	1.2
Fe	10mA	248.8 and 372.0nm	15nm	"	7	1.5
Pb	4mA	217.0nm	30nm	"	7	2.5
Ca	5mA	422.7nm	300nm	"	7	2.5

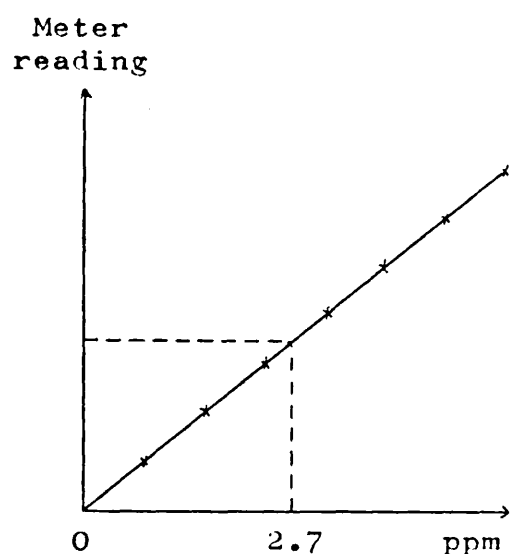

Standards

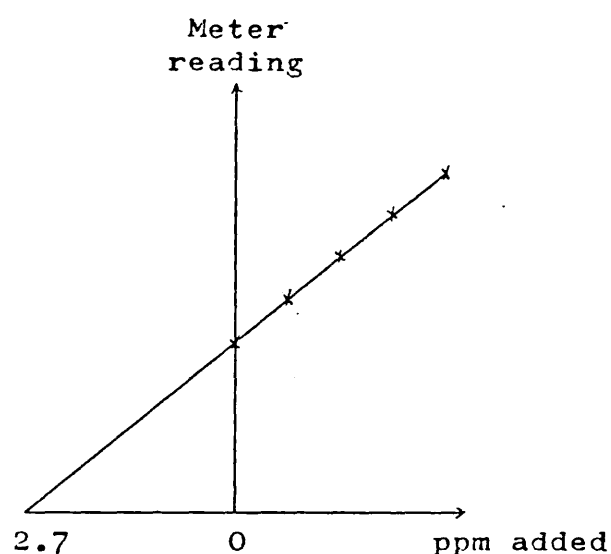

Standard addition

2. Locating reagents employed in paper and thin-layer chromatography

Zinc

KCN masked dithizone in chloroform (Mager (1953))

Dithizone in chloroform 0.005% (m/v)

Copper

Oxine - 8-hydroxyquinoline 1.5% in ethanol-water (1:1 by volume)

Diethyldithiocarbamate 5% in water, followed by exposure to ammonia fumes

α -pyridylazo- β -naphthol 1% solution in ethanol

Iron

Potassium ferrocyanide 6% aqueous solution

Potassium ferricyanide 6% aqueous solution

Amino acids

Ninhydrin 8% solution in butanol

Carbohydrates

Aminobiphenyl-orthophosphoric acid solution, 0.3g

o-aminobiphenyl + 5 cm³ H₃PO₃ in 95 cm³ ethanol

p-anisidine-phthalic acid, 1.23g p-anisidine + 1.66g
phthalic acid in 100 cm³ methanol

Phenols

Ferric chloride-ferricyanide 0.05M solution of each

Carboxylic acids

Bromocresol green 0.1% in ethanol. 1.0M NaOH solution
added to chromatogram.

- Bradshaw, A.D. Nature 169 1098 (1952)
- Bradshaw, A.D., McNeilly, T.S. and Gregory, R.P.G.
Symp. Br. Ecol. Soc. 5 327 (1965)
- Bremner, I and Knight, A.H.
Br. J. Nutrition 24 279 (1970)
- Broker, W. Sm. Flora Jena 153 122 (1963)
- Brown, J.C. and Holmes, R.S.
Pl. Physiol 30 451 (1955)
- Brownall, P.F. Pl. and Soil 28 161 (1968)
- Butler, G.W. and Peterson, P.J.
Aust. J. Biol. Sci. 20 77 (1967)
- Cannon, H. Science 132 2427 591 (1960)
- Carter, O.G. and Lathwell, D.J.
Pl. Physiol. 42 1407 (1967)
- Cartwright, B. Studies of Copper Def. in Nodulated
Subterranean Clover, Ph.D. Thesis
Nottingham Univ. (1966)
- Cedano-Maldonado, A., Swader, J.A. and Heath, R.L.
Pl. Physiol. 50 (6) 698 (1972)
- Chaudry, F.M. Ph.D. Thesis, Univ. of W. Australia (1971)
- Chikishev, A.G. Plant Indicators of Soils, Rocks and
Subsurface Waters, Consultant's Bureau
New York. (1965)
- Clark, A. Unfinished Ph.D. Thesis, Bedford College,
Univ. of London. (1976)
- Dainty, J. and Hope, A.B.
Aust. J. Biol. Sci. 12 395 (1959)
- Danielli, J.F. and Davson, H.
J. Cell and Compar. Physiol. 5 495 (1935)

- Daniels, P.R., Stuckmeyer, B.E. and Peterson, L.A.
J. Am. Soc. Hort. Sci. 98 (1) 31 (1973)
- De Kock, P.C. Annals of Bot. Vol. 20 77 133 (1956)
- Diez-Altare, C. and Burroughs, H.
Turrialba 11 162 (1961)
- Diez-Altare, C. and Bornemisza, E.
Pl. and Soil 26 175 (1967)
- Drosdorff, M., Patter, G.F., Shear, C.B. and Crone, H.L.
Fruit Nutrition 725, Somerset Press
Somerville, N.J., P. 907 (1954)
- Dykeman, W.K. and de Sousa, A.S.
Can. J. Bot. 44 871 (1966)
- Earley, E.B. J. Am. Soc. Agron. 35 1012 (1963)
- Edwards, C., Olsen, K.B., Heggen, G. and Glenn, J.
Proc. Soc. Expt. Biol. Med. 107 94 (1961)
- Ennis, M. Irish J. Agric. Res. 1 147 (1962)
- Epstein, E. Mineral Metabolism. In Plant Biochem.
Eds. J. Bonner and J.E. Varner. Acad.
Press. New York and London. P. 438 (1965)
- Epstein, E. Nature 212 1324 (1966)
- Epstein, E. Mineral Nutrition in Plants: Principles
and Perspectives. Wiley (1972)
- Epstein, E. Sci. Am. May P. 43 (1973)
- Ernst, W. Ber. Deut. Bot. Ges. 78 205 (1965)
- Ernst, W. Physiol. Plant 21 323 (1968)
- Ernst, W. Ber. Deut. Bot. Ges. 82 161 (1969)
- Esau, K. Plant Anatomy, Wiley. New York. (1953)
- Fare, G. and Sammons, D.C.H.
Experimenta 22 668 (1966)

Findenegg, G. and Broda, E.

Nature (London) 208 196 (1965)

Florkin, M. and Stotz, E.H.

Comprehensive Biochem. P. 235 (1963)

Gilbert, S.G.

Pl. Physiol. (Lancaster) 26 398 (1951)

Gregory, L.P.G.

Ph.D. Thesis, Univ. of Wales (1964)

Gregory, R.P.G. and Bradshaw, A.D.

New Phyt. 64 131 (1965)

Gurr, E.

Methods of Anal. Histology and Histochem.

Leonard Hill (1958)

Hammett, F.S.

Protoplasma 5 (1927)

Hewitt, E.J. and Nicholas, D.J.D.

In Metal Inhibitors. Eds. R.M. Hochster
and J.H. Quastil (1963)

Hochster, R.M. and Quastel, J.H.

Metal Inhibitors. Acad. Press. New York
and London, (1969)

Hoefner, W.

Landwort Forsch 21 (3 - 4) 259 (1968)

Hoover, W.L.

J. Ass. Off. Anal. Chem. 55 (4) 737 (1972)

Howard-Williams, C.

Kirkia 8 91 (1970)

Jellinck, L.H.G. and Sengal, S.P.

Water Res. 6 305 (1972)

Johnson, W.T. and Schrenk, W.G.

Trans. Kan. Acad. Sci. 66 (3) 429 (1963)

Johnson, C.M., Stout, P.R., Broyer, T.C. and Carlton, A.B.

Pl. and Soil 8 337 (1957)

Jones, C.H.

Pl. and Soil 13 297 (1961)

Jowett, D.

Nature (London) 182 816 (1958)

Keegatra, K., Talmadge, K.W., Basser, W.D. and Albersheim, P.

Pl. Physiol. 51 188 (1973)

- Knight, A.H., Crooke, W.M. and Inkson, R.H.E.
Nature 192 142 (1961)
- Kositzin, A.V. and Igoshina, T.I.
Fiziol. Rast. 11 (2) 175 (1964)
- Laties, G.G. Ann. Rev. Pl. Physiol. 20 89 (1969)
- "
Lauchli, A. Planta 75 185 (1967)
- "
Lauchli, A. and Schwarlder, H.
Experientia 22 503 (1966)
- Levitt, J. Pl. Physiol. 26 59 (1951)
- Levitt, J. and Todd, G.W.
Physiol. Pl. 5 419 (1952)
- Lingle, J.C., Tiffin, L.O. and Brown, J.C.
Pl. Physiol. 38 71 (1963)
- Lyon, G.C., Peterson, P.J. and Brooks, R.R.
Planta 88 282 (1969)
- Mager, M., McNavy, w.F. and Lionetti, F.
J. Histochem, and Cytochem. 1 493 (1953)
- Morks, G.S. Heme and Chlorophyll. Chemical,
Biochemical and Medical Aspects
D. Van Nostrand Co. Ltd. London (1969)
- Mascarenho, J.P. and Machlis, C.
Pl. Physiol. 39 70 (1964)
- Mattson, S., Eriksson, E., Vahtras, E. and Williams, E.G.
Lanlbrffogsk Ann. 16 457 (1969)
- Meyer, R.E., Warren, G.F. and Langston, A.
Proc. Am. Soc. Hor. Sci. 70 334 (1957)
- Mills, C.F. Biochem, J. 57 603 (1954)
- Mills, C.F. Biochem. J. 63 187 (1956)
- Muzzarelli, R.A.A. Natural Chelating Polymers. Pergamon
Press (1973)

- Nicholas, D.J.D. J. Sci. Food Agric. 8 515 (1957)
- Nicols, O.W., Provan, D.M.J., Cole, M.M. and Tooms, J.S.
Trans. Instn. Min. Metall. 74 695 (1965)
- Nissen, P. Physiol. Pl. 24 315 (1971)
- Northcote, D.H. Ann. Rev. Pl. Physiol. 23 113 (1972)
- Novikoff, A.B. and Holtzman, E.
Cells and Organelles. Holt, Rinehart
and Winston Inc. (1970)
- Passow, H. Bibliothique Haematol. 6 111 (1968)
- Pastuska, G. Z. Anal. Chem. 179 427 (1961)
- Pearse, A.G. Histochem. Vol. I Ed. III Churchill (1968)
- Peterson, P.J. J. Exp. Bot. 20 863 (1969)
- Poole, R.J. Pl. Physiol. 44 485 (1969)
- Prevot, P. and Ollagnier, M.
Plant Analysis and Fertilizer Problems (1957)
- Rao, A.V., Fallin, E. and Rang, S.C.
Pl. Physiol. (Lancaster) 41 443 (1966)
- Rathore, V.S., Bajij, Y.P.S. and Wittwer, S.H.
Pl. Physiol. 49 207 (1972)
- Reilly, C. Nature (London) 215 667 (1967)
- Reilly, C. New Phytol. 68 1081 (1969)
- Reilly, C., Powell, J. and Stone, J.
New Phytol. 69 993 (1970)
- Schmidt, W.E. and Gerloff, G.C.
Pl. Physiol. 36 226 (1961)
- Schmidt, W.E., Haag, H.P. and Epstein, E.
Physiol. Pl. 18 860 (1965)
- Schweiger, R.G. Kolloid Zeitschrift and Z. for Polymere
208 28 (1966)

- Sevag, M., Lackman, D.B. and Smolens, J.
J. Biol. Chem. 124 425 (1938)
- Shear, C.B., Crane, H.L. and Myers, A.T.
U.S. Dept. Agr. Tech. Bull. 1085 52 (1953)
- Smith, P.F.
Bot. Gazette 114 426 (1953)
- Smith, P.F.
Ann. Rev. Pl. Physiol. 13 81 (1962)
- Smith, P.F. and Specht, A.W.
Pl. Physiol. 28 371 (1953)
- Smith, R.C. and Epstein, E.
Pl. Physiol. 39 338 (1964)
- Stern, H.
Fractionation of Plant Cells. In
Biochemists Handbook. Spon. Lond (1968)
- Stewart, I.
Ann. Rev. Pl. Physiol. 14 295 (1963)
- Stocking, C.R. and Ongen, A.
Amer. J. Bot. 49 284 (1962)
- Stout, P.R.
Proc. Ninth Calif. Fertilizer Conf.
21 (1961)
- Thiers, R.E. and Vallee, B.L.
J. Biol. Chem. 226 911 (1957)
- Tiffin, L.O.
Pl. Physiol. (Lancaster) 41 510 (1966)
- Tiffin, L.O.
Pl. Physiol. (Lancaster) 42 1427 (1967)
- Tiffin, L.O. and Brown, J.C.
Science N.Y. 135 311 (1962)
- Timberlake, C.F.
J. Chem. Soc. 2795 (1959)
- Turner, R.G.
Ph.D. Thesis, Univ. of Wales (1967)
- Turner, R.G.
New Phytol. 69 725 (1970)
- Turner, R.G. and Marshall, C.
New Phytol. 70 (3) 539 (1971)
- Turner, R.G. and Marshall, C.
New Phytol. 71 671 (1972)

Udel'nova, T.M. and Brichenko, E.A.

Biokhimiym 32 779 (1967)

Victorov, S.V., Vostokova, Y.A. and Vyshivkin, D.D.

Short Guide to Geo-Botanical Surveying

Macmillan Co. N.Y. (1964)

Wagenecht, A.C. and Burris, R.H.

Arch. Biochem. 25 30 (1950)

Wallihan, E.F. and Heyman-Herschberg, L.

Pl. Physiol. 31 294 (1956)

Wilkins, D.A.

Report Scottish Pl. Breed. Stn.

P. 86 (1960)

Williams, M.C.

Pl. Physiol. 35 500 (1960)

Zweig, G. and Sherma, J.

Handbook of Chromatography, CRC Press (1972)