

A SPECTROSCOPIC AND THERMODYNAMIC INVESTIGATION OF
SOME IODINE OXYGEN FLUORINE COMPOUNDS

A thesis submitted by
MICHAEL ARTHUR JENKINSON
in candidature for the degree
of Doctor of Philosophy of
the University of London

October, 1972

Royal Holloway College,
Englefield Green,
Surrey.

R. H. C. LIBRARY	
CLASS	CBD
No.	Jen
ACC. No.	114,230
DATE ACQ	Mar. 73.

ProQuest Number: 10096776

All rights reserved

INFORMATION TO ALL USERS

The quality of this reproduction is dependent upon the quality of the copy submitted.

In the unlikely event that the author did not send a complete manuscript and there are missing pages, these will be noted. Also, if material had to be removed, a note will indicate the deletion.



ProQuest 10096776

Published by ProQuest LLC(2016). Copyright of the Dissertation is held by the Author.

All rights reserved.

This work is protected against unauthorized copying under Title 17, United States Code.
Microform Edition © ProQuest LLC.

ProQuest LLC
789 East Eisenhower Parkway
P.O. Box 1346
Ann Arbor, MI 48106-1346

Abstract

The solid-state infrared and Raman spectra of the dioxodifluoroiodate salts, MIO_2F_2 ($M = Na, K, Rb$ and NH_4), iodyl fluoride, IO_2F , and the Raman spectrum of iodine oxide trifluoride, IOF_3 are reported. Assignments of the vibrational frequencies of the $IO_2F_2^-$ ion and IOF_3 have been made and approximate stretching force constants calculated. Shifts in the positions of the stretching modes of MIO_2F_2 with changing cation are discussed. The vibrational spectrum of iodyl fluoride indicates the presence of a polymeric structure and various possible arrangements are suggested. The synthesis of complexes involving the iodyl ion, IO_2^+ , have been attempted.

Calorimetric measurements, in the isoperibol mode, of the enthalpies of hydrolysis of the dioxodifluoroiodate salts, iodine oxide trifluoride, iodyl fluoride, iodine pentafluoride and hexafluoroiodate compounds, MIF_6 ($M = K, Rb, Cs$) are reported. Using these and ancillary data the enthalpies of formation of the compounds have been calculated. Enthalpies of solution of iodic acid at varying dilutions have been measured in order to supplement the data needed in the determination of the enthalpy of formation of iodine pentafluoride. The value thus derived is in good agreement with those found from methods. 'Thermochemical' radii of the ions $IO_2F_2^-$ and IF_6^- have been calculated from accepted procedures in order to determine the lattice energies of the salts. Additional lattice energies and enthalpies of formation of other salts containing these anions are thus reported.

Dedication

To my wife and parents.

Acknowledgements

The author wishes to express his gratitude to Dr. P.N. Gates and Dr. A. Finch for their help and encouragement throughout the course of this work and to the academic and technical staff of Royal Holloway College.

A grant from the Science Research Council is also gratefully acknowledged.

Contents

Section I	Introduction	
I/A	Iodine Oxygen Fluorine Compounds	7
I/B	Iodine Fluorine Compounds	26
Section II	Results and Discussion	
II/A	Spectroscopic Properties	38
i)	Dioxodifluoroiodate Salts, MIO_2F_2	40
ii)	Iodine Oxide Trifluoride, IOF_3	50
iii)	Iodyl Fluoride, IO_2F	56
iv)	Hexafluoroiodate Compounds, MIF_6	67
II/B	Thermodynamic Properties	
i)	Dioxodifluoroiodate Salts	70
ii)	Hexafluoroiodate Compounds	83
iii)	Iodine Oxide Trifluoride	91
iv)	Iodyl Fluoride	94
v)	Iodine Pentafluoride	96
Section III	Experimental	
III/A	Purification, Preparations and Analyses	107
III/B	Spectroscopy	122
III/C	Calorimetry	124
Appendix I	Lattice Energies	140
Appendix II	Errors	145
Appendix III	Corrections	146
References		148

SECTION I

INTRODUCTION

I - A Iodine Oxygen Fluorine Compounds

A number of iodine (V) and iodine (VII) oxygen fluorine compounds are known and a review of the properties and reactions of some of these was published in 1963.¹

It is sometimes beneficial in understanding the properties of compounds, especially the interpretation of vibrational spectra, to compare the properties of related species. Therefore, this introduction is intended to review a wider scope of compounds than perhaps those which are of direct interest to this work.

I - A.1 Dioxodifluoroiodate Salts, MIO_2F_2

The preparation of dioxodifluoroiodate salts was reported by Weinland^{2,3} et.al. Solutions of the appropriate iodate, MIO_3 ($\text{M} = \text{Na}, \text{K}, \text{Rb}, \text{Cs}, \text{NH}_4$), in 40% hydrofluoric acid were allowed to evaporate over several days during which time colourless crystals formed.

The crystal structure of KIO_2F_2 was determined by Helmholtz and Rogers⁴, using x-ray crystallography. They found that the structure could be best thought of as a trigonal bipyramid with the fluorine atoms occupying the axial positions and the oxygen atoms and the nonbonding electron pair occupying the equatorial positions, (figure I - A.1). This arrangement is in agreement with other observed trigonal bipyramidal molecules⁵⁻⁷ where the most electronegative groups tend to occupy axial positions.

The infrared⁸⁻¹⁰ and Raman⁸ spectra of KIO_2F_2 have been reported. Tentative assignments of vibrational modes have been made by Carter and Aubke⁸ based upon the trigonal bipyramidal, C_{2v} , structure of Helmholtz and Rogers. They found that the iodine-oxygen stretching modes were split and, together with the iodine-

FIGURE: I-A.1. STRUCTURE OF THE DIOXODIFLUORO-
IODATE ION*

*(from L.Helmholz and M.T.Rogers, reference 4)

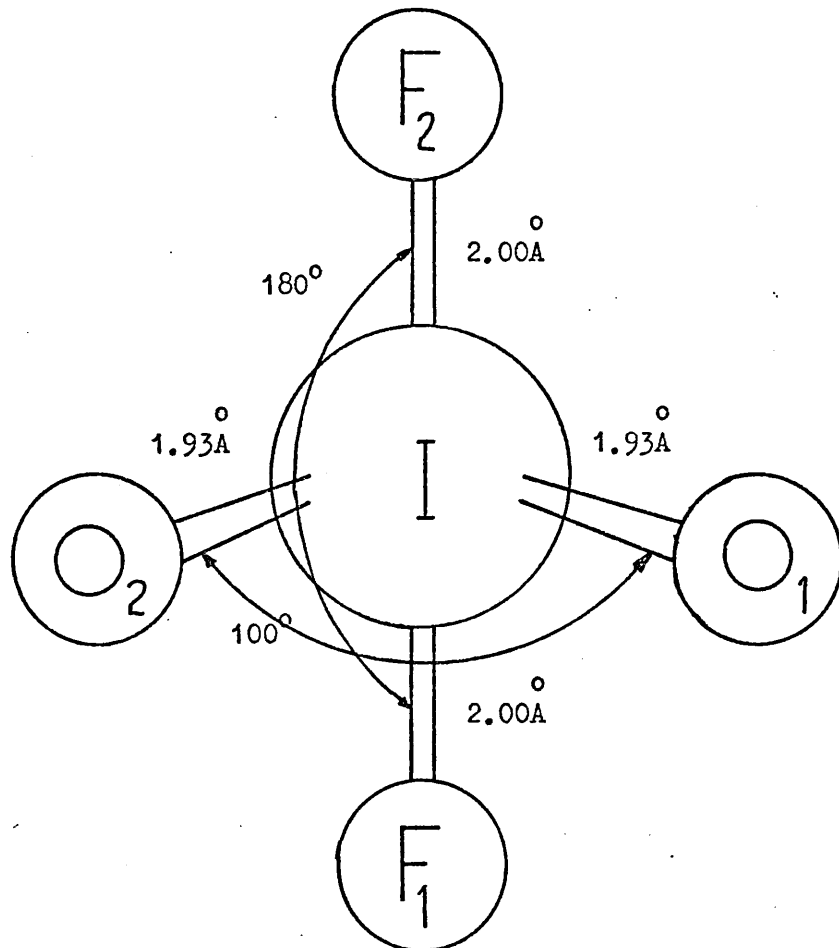

fluorine stretching modes, were at lower frequency than had been recorded for other similar molecules. It was also noticed that only one iodine-fluorine stretching mode could be observed in the Raman spectrum, indicating a nearly linear F - I - F arrangement as the antisymmetric iodine-fluorine stretch was assumed to be too low in intensity to be detected. This mode was, however, assigned in the infrared spectrum.

Until recently the IO_2F_2^- ion was the only oxyfluorohalogen ion known. Various claims had been made by Mitra and Ray¹¹⁻¹⁵ for the preparation of other ions. However, these were later retracted¹⁶ when the 'products' were found^{17,18} to be only the unchanged starting materials. The salt caesium dioxodifluorochlorate, $\text{Cs Cl O}_2 \text{F}_2$, has now been synthesised¹⁸ by the reaction of caesium fluoride and chloryl fluoride

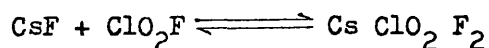

The above reaction is reversible at higher temperature as, although the salt is stable at 25°C, if it is heated to 80 - 100°C in a vacuum 90 - 95% of the original chloryl fluoride is liberated. The chlorine salt seems to be more reactive than its iodine counterpart as it is explosively hydrolysed by water.

The vibrational spectra of $\text{Cs ClO}_2 \text{F}_2$ have been reported by Christie and Curtis¹⁹. The infrared and Raman spectra were compared with the frequencies and intensities of vibrational modes in the spectra of molecules such as XeO_2F_2 and ClO_2F and ions such as ClO_2^+ and ClF_2^- . A structure of a trigonal bipyramid, with fluorine atoms occupying the two axial positions and the oxygen atoms and the non-bonding electron pair occupying the three equatorial positions, was inferred.

A normal co-ordinate analysis was carried out both to aid the spectral assignment and to give an indication of the strengths of the various bonds. The computed force constants could only be

of an approximate nature as the geometry of the molecule had to be estimated. Comparison of the Cl = O stretching force constants showed only a slightly lower value compared with those of related molecules, which could be due to different physical states (solid vs gas). The Cl - F stretching force constant, however, had an unusually low value compared with related molecules. This observation was rationalised by two considerations: (a) the formal negative charge will not be concentrated at the central atom but will be distributed mainly over the highly electronegative fluorine atoms and (b) it had been previously noted¹⁹ that when two chlorine-fluorine bonds or an unshared electron pair are replaced by a doubly bonded oxygen atom the remaining Cl - F bonds are significantly weakened. Thus, the conclusions made from the force constant data were that the Cl = O bonds are predominantly covalent whereas the Cl - F bonds contain a strong ionic contribution. These conclusions were in agreement with previous predictions²⁰.

The recently prepared compound²¹, XeO_2F_2 , is isoelectronic with the IO_2F_2^- ion and its vibrational spectra have now been reported²². From the infrared and Raman spectra it was found, from the number of Xe = O stretching modes and stretching modes characteristic of a linear F - Xe - F structure, that the compound is the simple XeO_2F_2 molecule and not the possible complex $\text{XeO}_3 \cdot \text{XeOF}_4$. The infrared spectrum, recorded in an argon matrix at liquid helium temperature, and the liquid Raman spectrum were found to be entirely consistent with the proposed C_{2v} symmetry of a trigonal bipyramid structure with the fluorine atoms in the axial positions and the oxygen atoms and the non-bonding electron pair in the equatorial positions.

The Raman spectrum of the solid showed some marked shifts from the liquid spectrum. This was thought to be due to the possibility of polymerisation through the fluorine atoms, which is thought to occur in XeF_6 ²³, and which is also indicated by a rather broad band in the liquid Raman spectrum in the Xe - F stretching region. It was thought that if any polymerisation does occur it is not through the equatorial oxygen atoms because of the close co-incidence of the two Xe = O stretching modes in the low temperature matrix infrared and the liquid Raman spectra.

Iodine Oxide Trifluoride IOF₃

Iodine oxide trifluoride was first obtained by Ruff and Braida²⁴ from iodine pentafluoride by three methods: (a) as an impurity in the preparation of iodine pentafluoride from its elements, provided a small amount of oxygen was present; (b) by the addition of a small amount of water to iodine pentafluoride; and (c) by the reaction between iodine pentafluoride and iodine pentoxide. They believed the last reaction to be reversible on heating. Aynsley et. al.²⁵ investigated these reactions further, and found that the first two reactions gave impure products. However, iodine pentoxide dissolved smoothly in an excess of boiling iodine pentafluoride which on cooling to room temperature deposited white, needle-like crystals. It was also observed that this reaction was not reversible on heating as at 110°C IOF₃ decomposed to iodine pentafluoride and a new compound iodyl fluoride, IO₂F. However, this latter reaction was found to be reversible as IOF₃ was again obtained on the dissolution of iodyl fluoride in hot iodine pentafluoride.

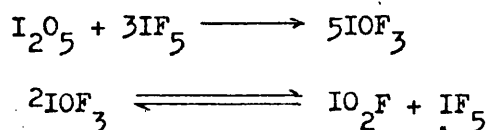

IOF₃ was also obtained by Aynsley^{26,27} as a product from the reactions

FIGURE: I-A.2 STRUCTURE OF IODINE OXIDE TRIFLUORIDE*

* (from: H.W.Baird and J.W.Viers, reference 29)

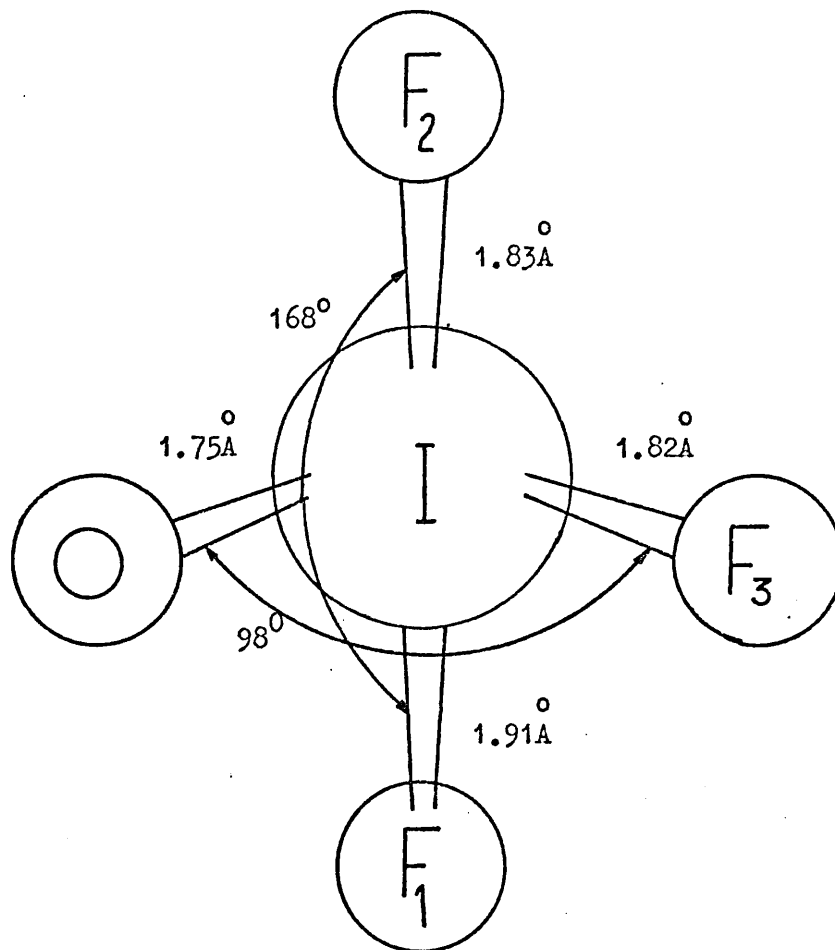

of iodine pentafluoride with (a) potassium per-rhenate and (b) potassium permanganate ∴.

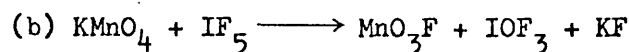
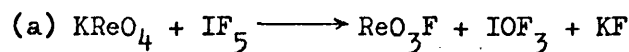

Aynsley postulated²⁵ that the structure of IOF_3 could be of the form $\text{IO}_2^{\oplus} \text{IF}_6^{\ominus}$ as the decomposition on heating showed a resemblance to the behaviour of the then recently prepared²⁸, KIF_6 i.e.

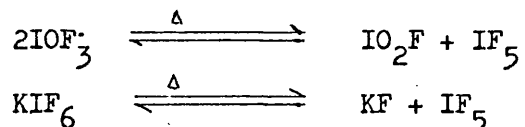

However, this postulate proved to be incorrect as an x-ray study by Viers and Baird^{29,30} has shown that IOF_3 exists in the molecular configuration of a distorted trigonal bipyramid in which the oxygen atom and the unshared electron pair occupy two of the three equatorial positions and the fluorine atoms occupy the axial positions and the third equatorial site, a similar structure to that of the IO_2F_2^- ion, as shown in figure I - A.2.

The structure of IOF_3 is distorted from a regular trigonal bipyramid. The equatorial O - I - F₃ bond angle has been reduced to 98° from the regular 120°. The bond angle of the axial fluorine atoms, F₁ - I - F₂, has been distorted from linear to 168° by the influence of the lone pair. The unequal axial I-F bond distances can be seen as evidence for strong intermolecular interactions between I-F₂ bonds of adjacent molecules, the distances being shorter than the sum of the van 'der Waals' radii.

The expected symmetry for IOF_3 would thus be C_{2v}. The Raman spectrum has been reported by Carter and Aubke⁸, although infrared data could not be obtained due to the reactivity of the compound. Seven of the nine expected bands were observed, the remaining two, which were deformation bands were thought to be obscured by a strong background

scattering. An assignment was made with the help of the vibrational assignment of IOF_3 ³¹ for which Raman polarisation data in the liquid had made more definite assignments. The deformation bands could only be assigned tentatively.

The compound chlorine oxide trifluoride, ClO_3F , has recently been prepared³² by ultra-violet irradiation (mercury vapour lamp) of a mixture of ClF_3 and OF_2 . ClO_3F is a white solid, m.p. - 44°C and b.p. 27°C. The infrared spectrum of the gas and the Raman spectrum of the liquid have been recorded. The shifts in frequencies between these two measurements seem to indicate a degree of association, probably through the fluorine atoms in the liquid phase.

A species isoelectronic with IOF_3 is the XeOF_3^+ cation which has recently been characterised³³ in $\text{XeOF}_3^+ \text{Sb}_2\text{F}_{11}^-$. This work involved the use of ^{19}F n.m.r. of the compound dissolved in antimony pentafluoride. The solution was supercooled at 5°C long enough to obtain the n.m.r. spectrum. This spectrum was of AX_2 type, consistent with the structure of a trigonal bipyramid in which a fluorine atom, an oxygen atom and the lone pair occupy equatorial positions and two fluorine atoms occupy axial positions. The Raman spectrum was also consistent with the formulation $\text{XeOF}_3^+ \text{Sb}_2\text{F}_{11}^-$. Assignments of the stretching modes were made by comparison with IOF_3 and XeF_3 ³⁴, which has a similar structure with the double-bonded oxygen atom being replaced by a lone pair.

Iodyl Fluoride, IO_2F

Iodyl fluoride is a white solid, completely stable at room temperature and evolves hydrogen fluoride slowly in moist air. It was first prepared by Aynsley et. al.²⁵, as described above. An alternative synthesis, reported by Schmeisser and Lang³⁵, involved the action of fluorine upon a solution of either iodine pentoxide or iodic acid in liquid hydrogen fluoride.

The infrared spectrum of iodyl fluoride has been published by Schenk and Gerlatzek³⁶. A more detailed infrared and Raman study by Carter and Aubke⁸ has also been reported. Both the infrared and Raman spectra were too complex for the simple IO_2F formulation when compared with similar molecular types, such as IOF_5 ³¹ and ClO_2F ³⁷. It was thus concluded that iodyl fluoride might exist in a polymeric structure, although association through oxygen or fluorine could not be decided.

Reactions of iodyl fluoride have been carried out in an attempt to prepare compounds containing the IO_2^+ cation. Iodyl fluoride is stated³⁵ to dissolve as a 'base' in liquid hydrogen fluoride and iodyl salts may thus be prepared by neutralisation of compounds that function as acids in this system³⁵. BF_3 or AsF_5 were passed into the solution and white crystalline $\text{IO}_2 \cdot (\text{BF}_4)$ or $\text{IO}_2 \cdot (\text{AsF}_6)$ isolated³⁵. The reaction with BF_3 , however, could not be repeated by Aynsley and Sampath³⁸, even by varying the solvents. They also tried to form complexes containing the IO_2^+ cation by passing such compounds as SiCl_4 , BF_3 , AsF_5 or SO_3 directly over solid iodyl fluoride but without any detectable reaction. The compound of the composition $\text{IO}_2\text{F} \cdot 0.8 \text{SbF}_5$ was, however, formed when antimony pentafluoride was heated with iodyl fluoride. The absence of complexing reactions led Aynsley to suggest that the $\text{IO}_2^+ (\text{AsF}_6)^-$ complex may rather be formulated as $\text{AsF}_4^+ \text{IO}_2\text{F}_2^-$, due to the isolation of compounds such as KIO_2F_2 . This suggestion, however, proved to be incorrect. Pitts et al.⁹ prepared samples of both KIO_2F_2 and AgIO_2F_2 and recorded the infrared spectra. KIO_2F_2 was then dissolved in liquid hydrogen fluoride and AsF_5 condensed into the solution. The resulting white solid was shown by chemical means to contain AsF_6^- ions but no K^+ ions. The infrared spectrum also showed bands characteristic of the AsF_6^- ion and contained

no bands characteristic of the IO_2F_2^- ion.

Iodyl fluoride reacts with an excess of sulphur trioxide under reflux to form the compound iodyl fluorosulphate, $\text{IO}_2\text{SO}_3\text{F}$ ³⁵. This compound has also been prepared by Aubke, Cady and Kennard³⁹ by the reaction of iodine pentoxide with peroxydisulphuryl difluoride⁴⁰, $\text{S}_2\text{O}_6\text{F}_2$, which is known to be a successful reagent for preparing fluorosulphates^{41,42}.

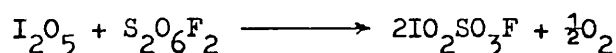

Iodyl fluorosulphate is a pale yellow very hygroscopic powder which is stable up to 100°C.

The vibrational spectra of the compounds IO_2AsF_6 and $\text{IO}_2\text{SO}_3\text{F}$ has been recorded by Carter and Aubke⁸ in order to determine if these compounds contain discrete IO_2^+ cations. Conductrometric solution studies of $\text{IO}_2\text{SO}_3\text{F}$ in fluorosulphonic acid were also undertaken as Gillespie and Senior⁴³ had failed to establish the existence of the IO_2^+ cation in the sulphuric acid solvent system, with iodic acid as the solute. The Raman spectrum of IO_2AsF_6 could not be obtained due to strong background scattering. Also, the infrared spectrum of $\text{IO}_2\text{SO}_3\text{F}$ could not be recorded due to its reaction with the plates.

The infrared spectrum of IO_2AsF_6 did not show any absorption bands in the 800 - 900 cm^{-1} region, which is the region expected for the stretching modes of the IO_2^+ cation. Absorption bands were, however, present at the expected region for the two infrared-active bands of the AsF_6^- ion. From these observations two possible conclusions could be drawn. The first was complex formation between polymeric IO_2F and AsF_5 via oxygen, as had recently been observed for SeOF_2 . NbF_5 ⁴³. However, the authors conceded that it would be surprising, if this explanation were correct, to find As-F stretching and bending modes corresponding to the AsF_6^- ion. The second explanation was the

formation of an I - O - I bridged polymeric cation with AsF_6^- as the counter ion. Other vibrational bands could perhaps be attributed to bridging iodine-oxygen groups with other possible bands being obscured in the arsenic-fluorine regions of the spectrum. Thus, with no Raman spectrum available to aid the assignments no clear distinction could be made between these alternatives. However, it was concluded that no discrete monomeric IO_2^+ cation exists in IO_2AsF_6 .

The Raman spectrum of $\text{IO}_2\text{SO}_3\text{F}$ seemed to indicate a very different structural type. Very intense bands were found in the iodine-oxygen stretching region, but the spectrum contained far too many bands for a simple $\text{IO}_2^+ \cdot \text{SO}_3\text{F}^-$ formulation. The increase in the number of observed vibrational modes was taken as an indication of a lowering of symmetry of the SO_3F group from C_{3v} to C_s , which would be expected to increase the number of infrared and Raman active bands from 6 to 9. The point group C_s is expected for SO_3F when the group acts as a monodentate or a bidentate group where bridging occurs through oxygen only; for the bidentate case a bridging or chelating arrangement is possible. Bidentate bridging groups had been found^{44,45} in certain tin (IV) fluorosulphates e.g. $(\text{CH}_3)_2\text{Sn}(\text{SO}_3\text{F})_2$ where confirmation by x-ray diffraction⁴⁶ had been made. Comparison of the vibrational modes assigned to the SO_3F group in $\text{IO}_2\text{SO}_3\text{F}$ and $(\text{CH}_3)_2\text{Sn}(\text{SO}_3\text{F})_2$ showed very good agreement. Therefore, the authors assigned these vibrations to a bidentate fluorosulphate group. The observed physical properties i.e. lack of volatility and the solution behaviour resulted in the favouring of a bidentate bridging group rather than a bidentate chelating arrangement. This would then result in a polymeric structure. Thus, unlike IO_2AsF_6 , where polymerisation is thought to occur via I - O - I groups, $\text{IO}_2(\text{SO}_3\text{F})$ appears to have a polymeric

structure with discrete IO_2 groups and polymerisation through bridging anionic groups. A trigonal bipyramidal configuration with the lone pair and both oxygen atoms in the equatorial positions and bridging SO_3F groups in the axial positions was suggested.

The solution behaviour of $\text{IO}_2\text{SO}_3\text{F}$ in fluorosulphonic acid also seemed to indicate a polymeric structure since even small amounts took several hours to dissolve, consistent with a slow breaking up of a polymeric species. The conductivity experiments carried out on these solutions indicated that, even at very low concentrations, iodyl fluorosulphate is not completely dissociated into IO_2^+solv and SO_3F^- .

Bromyl fluoride, BrO_2F , was prepared by Schmeisser and Pammer^{47,48} by the following methods (a) fluorination of bromine dioxide suspended in perfluoropentane, C_5F_{12} , at -50°C ; (b) fluorination of bromine dioxide by liquid bromine pentafluoride at -55°C ; (c) reaction of potassium bromate with bromine pentafluoride at its melting point (-61.4°C) (d) passing a stream of ozone diluted with oxygen through a solution of bromine in bromine pentafluoride at -5°C . Bromyl fluoride has also been detected⁴⁹, by means of mass spectroscopy, in partially hydrolysed bromine trifluoride.

Bromyl fluoride forms colourless crystals which may be sublimed under vacuum at -25°C . It melts at -9°C to a colourless liquid which decomposes slowly at room temperature. It is a very reactive compound; the liquid attacks glass and is explosively hydrolysed by water. No spectral data have been published for this compound.

Chloryl fluoride, ClO_2F , has been prepared by the following methods: (a) fluorination of potassium chlorate by elemental fluorine⁵⁰⁻⁵³ or fluorinating agents such as BrF_3 , ClF_3 ^{52,54} or fluorosulphonic

acid⁵⁵; (b) reaction of chlorine dioxide with (i) fluorine^{56,57} at suitable partial pressures or dissolved in solvents such as CFCl_3 , or (ii) argentic fluoride⁵⁸; (c) thermal decomposition of dichlorine hexoxide in the presence of fluorine between 22° and 48°C ^{59,60} or the reaction of dichlorine hexoxide with bromine trifluoride or pentafluoride.

The physical properties of chloryl fluoride were recorded by Schmitz and Schumacher⁶². It is a colourless gas (m.p. -115°C and b.p. -6°C) with a measured heat of vapourisation of 6.2K.cal. mole.⁻¹. It is thermally reasonably stable with decomposition occurring only above 300°C in a quartz vessel. Glass is only slowly attacked at room temperature, although this reaction is rapid if a trace of water is present.

The infrared spectrum of chloryl fluoride was first recorded by E.A. Smith et. al.⁶³ and later by Arvia and Aymonino⁶⁴. A study by D.F. Smith, Begun and Fletcher³⁷ has also recorded the liquid Raman spectrum and has identified all six fundamentals. Assignments were made on the basis of the pyramidal C_s symmetry model, rather than the less likely planar C_{2v} symmetry model, which was not indicated from the polarisation data available. The $^{35}\text{Cl} - ^{37}\text{Cl}$ isotope shifts supported the assignments. Valence force constants were calculated and these gave values closely resembling the observed fundamental frequencies and their isotope shifts. The calculated Cl-F stretching force constant was found to be one of the lowest yet reported, suggesting a large ionic character in the bond. The Cl-O stretching force constant, however, was considerably larger than that of the isoelectronic ClO_3^- ion or the ClO_2 molecule. It was thus concluded that the Cl-O bond in ClO_2F has considerably greater double bond character than in ClO_3^- or ClO_2 and a bond shortening would be

expected to be the result.

Although bromyl fluoride shows very little tendency to form complexes containing the BrO_2^+ cation (there is no reaction between BrO_2F and BF_3 , AsF_5 and SbF_5) chloryl fluoride shows a marked increase in its complexing power with other fluorides in comparison with iodyl fluoride. These chloryl compounds can be divided into two groups: (a) chloryl fluoride and its reaction with strong Lewis acids such as SbF_5 , AsF_5 , BF_3 , PF_5 , VF_5 , SnF_4 etc.^{58,65,66}, which are colourless and moderately reactive compounds; and (b) chloryl fluorosulphate^{65,66} $(\text{ClO}_2).\text{SO}_3\text{F}$ and dichloryl trisulphate $(\text{ClO}_2)_2\text{S}_3\text{O}_{10}$ ⁶⁷ which are deep red solids at room temperature, fading to pale yellow at liquid nitrogen temperature, and are highly reactive. Two studies^{68,69} of the ClO_2^+ cation have been published recently. Both groups of workers have recorded the infrared and Raman spectra of ClO_2AsF_6 , although some inconsistencies are present between their reported spectra. However, both groups conclude that ClO_2AsF_6 exists in a simple ionic form with distortion of the AsF_6^- group from a regular octahedron. Christie et. al.⁶⁸ has also recorded the vibrational spectrum of ClO_2BF_4 which also appears to be of the simple ionic form with slight distortion of the BF_4^- group. However, unlike ClO_2AsF_6 , ClO_2BF_4 is unstable at room temperature which means that by measuring the dissociation pressure at varying temperatures a heat of formation can be derived. The calculated heat of formation of $\Delta H_f^\circ [\text{ClO}_2^+ \text{BF}_4^-]$ (c) = $-303 \text{ Kcal.mol}^{-1}$. Christie also calculated the force constants for the ClO_2^+ cation which were found to be almost the same as those in ClO_2F , very much as expected. The other group of workers⁶⁹ has carried out solution studies of IO_2AsF_6 and ClO_2F in fluorosulphonic acid. They concluded that both compounds produce the red ClO_2^+ (solv) in solution.

The preparation of the XeO_2F^+ ion, which is isoelectronic with IO_2F , has recently been published³³. It exists as the yellow solid complex $\text{XeO}_2\text{F}^+ \cdot \text{Sb}_2\text{F}_{11}^-$ which when dissolved in antimony pentafluoride shows only a single line attributable to the XeO_2F^+ in the ^{19}F n.m.r. spectrum. The Raman spectrum of the complex showed one stretching frequency in the Xe -F region and two in the Xe=O region. Thus, it was concluded that XeO_2F^+ exists in the expected pyramidal structure, analogous to the isoelectronic XeO_3 .

Periodyl Fluoride, IO_3F

Periodyl fluoride was first prepared by Schmeisser and Lang³⁵ by the reaction of fluorine with periodic acid dissolved in anhydrous hydrogen fluoride.

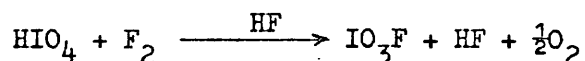

The IO_3F produced by this method tended to be contaminated with IO_2F . Paul, Paul and Malhotra⁷⁰ have reported an alternative preparation of periodyl fluoride. They heated a mixture of potassium periodate and fluorosulphonic acid (1:2 moles with HSO_3F in slight excess) to 60° until the colour changed from yellow to white. The solid formed was filtered in a dry nitrogen atmosphere and washed with dry disulphuryl fluoride⁷¹, $\text{S}_2\text{O}_5\text{F}_2$, and dried under vacuum.

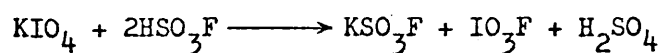

Periodyl fluoride is a stable white crystalline substance which is more stable to hydrolysis than iodyl fluoride. It decomposes at about 100°C into IO_2F and oxygen. An infrared spectrum has been recorded⁷⁰ and a polymeric structure with O - I - O chains was tentatively suggested. Assignments of the observed spectrum were made assuming the suggested structure.

The tendency of IO_3F to form complexes of the IO_3^+ cation is

less than IO_2F . However, HBF_4 is stated³⁵ to react with IO_3F in liquid hydrogen fluoride to form the white crystalline solid $\text{IO}_3(\text{BF}_4)$. The reaction with HASF_6 results in the solvated product of composition $\text{IO}_3(\text{AsF}_6) \cdot 10\text{HASF}_6$. Compounds containing bromine and fluorine generally tend to be more reactive than their chlorine or iodine counterparts. This observation is true for perbromyl fluoride, BrO_3F , which has only recently been prepared⁷². It was prepared by the reaction of antimony pentafluoride with potassium perbromate⁷³, KBrO_4 , in liquid hydrogen fluoride at room temperature.

Pure BrO_3F is a colourless gas solidifying at about -110°C to a white solid. The infrared and Raman spectra of gaseous BrO_3F have now been published. Assignments were made with the aid of polarisation data and by comparison with the vibrational spectrum of ClO_3F . The results show that BrO_3F is isostructural with ClO_3F i.e. it exists as a tetrahedral molecule of C_{3v} symmetry.

Very little thermodynamic data are available for halogen oxyfluorine compounds. However, some of the thermodynamic properties of perbromyl fluoride have now been reported by Johnson, O'Hare and Appelman⁷⁵. They recorded calorimetrically the heat of hydrolysis of BrO_3F . Due to its high reactivity an 18-carat gold reaction vessel and platinum ampoules had to be used. From these measurements the enthalpy of formation, $[\Delta H_{f298}^\circ \text{BrO}_3\text{F}(c)]$ was found to be $26.78 \pm 0.25 \text{ K cal mole}^{-1}$. The vapour pressure of BrO_3F was measured between 188 and 292°K from which the following equation was derived $\ln p = 17.6986 - 3048.45T^{-1}$ (p in Torr, T in $^\circ\text{K}$). This equation led to an enthalpy of vaporisation $\Delta H_{\text{vap}}^\circ = 6.06 \pm 0.06 \text{ K cal mole}^{-1}$, giving $\Delta H_{f298.15}^\circ$ of $\text{BrO}_3\text{F}(g) = 32.84 \pm 0.26 \text{ K cal mole}^{-1}$. Also by means of statistical mechanics and using the vibrational data available⁷⁴ with an

estimated geometry the standard entropy of the ideal gas $S^{\circ}_{298.15}$ ($\text{BrO}_3\text{F}(\text{g})$) was calculated as $71.4 \pm 2 \text{ cal. deg.}^{-1} \text{ mole.}^{-1}$.

Perchloryl fluoride, ClO_3F , can be prepared by the following methods: (a) action of elemental fluorine on potassium chlorate at -40°C ^{50-53,76}; (b) electrolysis of sodium perchlorate in anhydrous hydrogen fluoride at 0°C ⁵²; (c) reaction of sodium perchlorate and fluorosulphonic acid at $60-70^{\circ}\text{C}$ ⁷⁷⁻⁷⁹; and (d) thermal decomposition of dichlorine heptoxide at 100° in the presence of fluorine. ⁸⁰.

Perchloryl fluoride is an exceptionally stable colourless gas, m.p. -146°C b.p. -46.7°C . Hydrolysis ^{52,81}, which yields fluoride and perchlorate, can only be effected by concentrated sodium hydroxide in a sealed tube at $200-300^{\circ}\text{C}$; only slight reaction occurs with water under the same conditions. The structure of ClO_3F is tetrahedral possessing C_{3v} symmetry determined from its infrared ^{52,74,82,83}, Raman ^{74,84} and microwave spectra ⁸⁵. An electron diffraction study ⁸⁶ has also determined the molecular parameters. The enthalpy of formation of ClO_3F was determined by Neugebauer and Margrave ⁸⁷ from the heat of hydrogenation in a bomb calorimeter. A revised value of $\Delta H^{\circ}_f \text{ClO}_3\text{F}(\text{g}) = -5.7 \pm 1.0 \text{ K.cal. mole.}^{-1}$ has been calculated by Cox ⁸⁸. The heat of vaporisation has also been determined by several workers ^{76,89,90}.

Perchloryl fluoride does not form perchloryl salts with fluorides such as:

BF_3 (at -120°C), AsF_5 (at -78°C), PF_5 (at -78°C and $+25^{\circ}\text{C}$) ⁷⁹. There is also no reaction between ClO_3F and SO_3 at -75°C . ⁷⁹

Tetrafluoroorthoperiodic Acid, HOIOF_4 and Iodine

Dioxide Trifluoride, IO_2F_3

The preparation of the above compounds has recently been reported by Engelbrecht and Peterfy ⁹¹.

Tetrafluoroorthoperiodic acid was prepared by the reaction

of barium paraperiodate⁹², $\text{Ba}_3\text{H}_4(\text{IO}_6)_2$, with a twenty fold excess of fluorosulphonic acid at 0°C .

A mixture of HSO_3F and HOIOF_4 was distilled from the reaction mixture at $46^\circ\text{C}/1$ torr. HOIOF_4 could not be separated from the remaining HSO_3F .

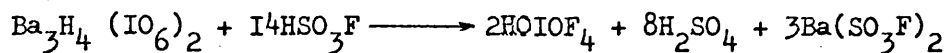

The ^{19}F n.m.r. spectrum of the mixture of HOIOF_4 and HSO_3F showed two isomers to be present, the Cis (C_{2v}) and trans (D_{4h}), of the octahedral ion $[\text{OIOF}_4]^-$, in the ratio of about 3:1.

On addition of SO_3 (60% oleum) the mixture of HOIOF_4 and HSO_3F turned yellow and yellow needle-like crystals of composition IO_2F_3 , determined from its mass spectrum, sublimed in vacuo.

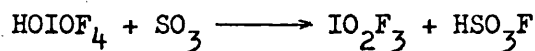

The melting point of IO_2F_3 was found to be $41 \pm 0.5^\circ\text{C}$.

It ignited on contact with inflammable organic substances and hydrolysed slowly to HF and H_5IO_6 . On exposure to direct sunlight it decomposed with the liberation of oxygen.

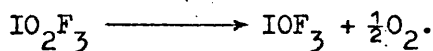

The ^{19}F n.m.r. spectrum of molten IO_2F_3 showed two doublet-triplet systems (AB_2 spin systems) in the ratio of about 3:1. This indicated, assuming the structure of IO_2F_3 to be a trigonal bipyramid, that two isomers, (C_{2v} and Cs) were present. The assignment of the spectrum was made noting that the signals of axial fluorine atoms always appear at lower field strengths than those of equatorial atoms. The chemical shifts of each of the axial and equatorial fluorine atoms corresponded very well to those of the two isomers of HOIOF_4 and were between those of IF_7 and IF_5 but very close to the resonance lines of IOF_5 .

Bromine dioxide trifluoride, BrO_2F_3 , has been observed⁴⁹ by means of mass spectroscopy in partially hydrolysed bromine trifluoride.

Iodine Oxide Pentafluoride, IOF_5

The discovery of IOF_5 took place by three groups of workers almost simultaneously. Gillespie and Quail⁹³ and Alexakos, Cornwall and Pierce⁹⁴ noticed slow changes in the ^{19}F n.m.r. spectrum of iodine heptafluoride contained in silica and pyrex tubes. They concluded that the new AB_4 spectrum obtained resulted from IOF_5 which contained one non-equivalent and four equivalent fluorine atoms. A single peak corresponding to SiF_4 was also observed. Bartlett and Levchuk⁹⁵ at this time prepared IOF_5 by three methods: (a) reaction of IF_7 with a small amount of water, $(\text{IF}_7 + \text{H}_2\text{O} \longrightarrow \text{IOF}_5 + 2\text{HF})$; (b) reaction of IF_7 with iodine pentoxide, $(3\text{IF}_7 + \text{I}_2\text{O}_5 \longrightarrow 3\text{IOF}_5 + 2\text{IOF}_3)$; and (c) reaction of IF_7 with silica, $(2\text{IF}_7 + \text{SiO}_2 \longrightarrow 2\text{IOF}_5 + \text{SiF}_4)$. A preliminary infrared spectrum was also reported. A more detailed n.m.r. study of IOF_5 and other heptafluoride and oxide pentafluoride molecules was published by Bartlett et.al.⁹⁶

The liquid Raman spectrum and the infrared spectrum of gaseous IOF_5 have been reported by Smith and Begun³¹. The results were consistent with an octahedral structure of C_{4v} symmetry, on which basis the assignments were made. Valence force constants were calculated and compared to similar molecules such as IF_5 and XeOF_4 showing close similarities. The most obvious difference, however, was the large stretching force constants of the equatorial bonds of IOF_5 , which were almost as large as the axial. This was seen as an indication of shorter I-F bond distances with perhaps the equatorial

and axial being almost the same.

A microwave study⁹⁷ has also confirmed the existence of a C_{4v} structure in IOF_5 and that $0 \leq r(I-F_{eq}) - r(I-F_{ax.}) \leq 0.10\text{\AA}$.

B. Iodine Fluorine Compounds

Halogen fluorine compounds have been subject to much study. Their use as fluorinating agents, especially in organic chemistry, is becoming increasingly important, due to the easier handling procedures made available by new inert materials. Many reviews of the physical, chemical⁹⁸⁻¹¹⁴ and spectroscopic¹¹⁵ properties of halogen fluorides have been published.

Of the four possible iodine fluorides all are known, although only the penta- and heptafluorides can be isolated as pure substances at room temperature. Several fluoroiodate ions¹¹⁶ are also known and their properties will also be included in the following discussion.

Iodine Monofluoride, IF

Iodine monofluoride cannot be isolated as a pure substance as it disproportionates into iodine and iodine pentafluoride at room temperature $5IF \rightarrow 2I_2 + IF_5$. It can be shown from the free energies of formation¹¹⁷ of IF and IF_5 that $\Delta G_{298}^{\circ} = -42.7 \text{ K.cal.mol}^{-1}$ for the disproportionation. The ΔG° value, however, does become positive at about 500°C which indicates that IF should be the stable and abundant species at that temperature.

Iodine monofluoride was first observed in the emission spectrum of the greenish-yellow flame formed by the combustion of methyl iodide¹¹⁸ or iodine¹¹⁹ in fluorine. From the observed spectrum a value of $66.2 \text{ K.cal.mol}^{-1}$ has been derived for the dissociation energy¹¹⁹. The enthalpy of formation of gaseous IF from the gaseous elements at 0°K can thus be obtained from the

dissociation energies of I_2 , F_2 , and IF :

$\Delta H_{fo}^\circ = -30.0 \pm 0.5 \text{ K.cal.mol.}^{-1}$. If this is corrected to 298°K and data for the solid rather than the gaseous state of iodine is used $\Delta H_{f298}^\circ IF(g) = -22.6 \pm 0.9 \text{ K.cal.mol.}^{-1}$.¹¹⁷ The equilibrium bond distance has also been found from the emission spectra¹²¹, giving $r_e = 1.908\text{\AA}$.

Schmeisser and Scharf¹²² have prepared iodine monofluoride by passing a mixture of fluorine and nitrogen through a solution of iodine in CCl_3F at -78°C . The brown insoluble solid obtained had the I:Fratio = 1:1.2. Schmeisser et. al.¹²³ have also prepared IF from IF_3 and iodine in the presence of methyl cyanide or pyridine at -40°C ; and also by the decomposition of IF_3 between -28°C and -12°C , at which temperature IF decomposes into IF_5 and iodine. IF has also been detected¹²⁴ as a relatively stable species in the disintegration of IF_5 in a mass spectrometer.

At present, no measurements of the infrared, Raman or n.m.r. spectra of IF have been published.

The salt containing IF_2^- anion, Et_4NIF_2 , was prepared¹²⁵ in methyl cyanide solution, according to the equation:
 $Et_4NICl_2 + 2AgF \longrightarrow Et_4NIF_2 + 2AgCl$. The Ag, K and Cs salts of the IF_2^- anion, however, could not be prepared by this reaction and no further information concerning the IF_2^- anion has been published.

Iodine Trifluoride, IF_3

Schmeisser and Scharf prepared iodine trifluoride by passing a mixture of nitrogen and fluorine through a solution of iodine in $CFCl_3$ at -78°C . The initial product was a suspension of the brown monofluoride which turned yellow as it was converted to

the trifluoride. On evaporation of the solvent under vacuum at -78°C a yellow solid was obtained. Differential thermal analysis (DTA) showed¹²³ that IF_3 decomposes at -28°C into IF and IF_5 . IF_3 has also been observed¹²⁴ as a stable species in the disintegration of IF_5 in a mass spectrometer.

No physical or thermodynamic properties of iodine trifluoride have been reported thus far. The average bond energy has however been estimated¹¹⁰ to be $65 \text{ K.cal.mol.}^{-1}$ from the bond energies of the other halogen fluorides. The enthalpy of formation of the gaseous compound from the elements at 298°K has been estimated to be $-120 \text{ K.cal.mol.}^{-1}$.

The salts $\text{IF}_2^+ \cdot \text{AsF}_6^-$ and $\text{IF}_2^+ \cdot \text{SbF}_6^-$ have been prepared^{126,127} from IF_3 and AsF_5 , and IF_3 and SbF_5 in AsF_5 as solvent at -78°C . The compound $\text{IF}_2^+ \cdot \text{SbF}_6^-$ is stable up to 45°C and the solid ^{19}F n.m.r. spectrum gives two broad overlapping bands whose relative intensities were estimated to be in the ratio of 1:2.6. These were assumed to arise from the fluorine in the iodine cation and fluorine in the antimony anion respectively. $\text{IF}_2^+ \cdot \text{AsF}_6^-$ was stable only to -20°C .

Two fluoroiodate (III) anions are known. The reaction of IF_3 with CsF (1:3 molar ratio) in MeCN at -78°C yields the compound Cs_3IF_6 ¹²³. The disproportionation of IF with CsF also gives Cs_3IF_6 . The compound is bright yellow and decomposes at about 104°C .

Salts of the IF_4^- ion have been prepared by various methods. Hargreaves and Peacock¹²⁹ report that KI , RbI and CsI dissolve in excess iodine pentafluoride at room temperature with the liberation of iodine. The excess solvent was pumped off and the products heated to 50°C - 70°C in vacuum leaving the white solids KIF_4 , RbIF_4 and the solvated CsI_2F_9 ($\text{CsIF}_4 \cdot \text{IF}_5$). The caesium product was converted

to CsIF_4 by further heating in vacuum at 100°C . These salts have also been prepared by the reaction of IF with the fluorides in MeCN solutions at -45° over periods of 8 - 9 hours¹²⁷ and by the reaction of fluorine^{130,131} and the respective iodides.

The Raman spectrum of $\text{Cs}^+ \text{IF}_4^-$ has been reported by Shamir and Yaroslavsky¹³². They found the spectrum to be complicated in comparison with the ions ClF_4^- ¹³³ and BrF_4^- ¹³² which have a square planar D_{4h} symmetry. They concluded from the number of bands that the structure of the ion was C_{2v} i.e. octahedral with two fluorine atoms occupying the axial positions and the two other fluorine atoms occupying two cis positions of the square equatorial plane, the two lone pairs of electrons occupying the other two cis positions of that plane. Christie¹³⁴, however, has commented that these results resemble the Raman spectrum of the IF_6^- ion, which is reasonable as CsIF_6 is also obtained from the same reactants under slightly different conditions. He also comments that a C_{2v} structure would be completely unexpected for IF_4^- .

Iodine Pentafluoride, IF_5

Iodine pentafluoride was first prepared on a reasonable scale by Moissan^{135,136} by the combination of the elements at room temperature. The preparation was confirmed by Prideaux¹³⁷ and improved by Ruff et. al.^{138,139}. IF_5 has also been prepared by many other methods including the fluorination of I_2 , HI, I_2O_5 and alkali metal iodides with various fluorinating agents.

Iodine pentafluoride is a colourless liquid at room temperature, m.p. 9.43°C and b.p. 100.5°C ¹⁴⁰. Its specific conductance¹⁴¹ ($5.4 \times 10^{-6} \text{ ohm}^{-1} \text{ cm}^{-1}$) indicates a degree of self-ionisation:

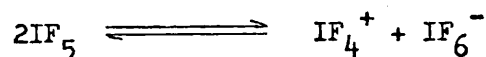

Complex forming substances such as SbF_5 , BF_3 , SO_3 , KIO_3 and HF greatly increase the conductance^{141,142}.

A square pyramidal, C_{4v} , structure of iodine pentafluoride was first proposed by Lord et.al.¹⁴³ from the analysis of the vibrational spectra. This has been confirmed by further infrared and Raman studies¹⁴⁴⁻¹⁴⁷, ^{19}F n.m.r. spectra¹⁴⁸⁻¹⁵⁰, microwave^{151,152} and electron diffraction¹⁵³. An earlier electron diffraction study¹⁵⁴ had proposed a trigonal bipyramidal structure but this was later shown by further electron diffraction studies¹⁵⁵ to be highly improbable. Lord¹⁴³ assumed that all five I-F bond lengths were equal (1.75Å) and the bond angles, $\text{F} - \text{I} - \text{F}^1$, between the equatorial fluorine atoms and the axial fluorine atom, to be about 105° . Begun et.al.¹⁴⁴ concluded that the axial I - F^1 bond distance (1.75Å) was shorter than the equatorial (1.86Å) with the $\text{F} - \text{I} - \text{F}^1$ angles close to 90° . Microwave and electron diffraction measurements agree closely with the x-ray determinations in that there is only a small difference between the axial and equatorial I-F bonds (average value 1.87Å) and the $\text{F} - \text{I} - \text{F}^1$ bond angle is approximately 81° .

The Raman spectrum of iodine pentafluoride contains three strongly polarised bands in the stretching region. This observation has been rationalised by several explanations. Gillespie and Clase¹⁴⁵ postulate this in terms of Fermi resonance, Selig and Holzman¹⁴⁶ suggest from temperature studies that polymerisation occurs; and Alexander and Beattie¹⁴⁷ have discussed the liquid spectrum in terms of an associated liquid. The ^{19}F n.m.r. spectrum of IF_5 ^{148-150,156,157} consists of a doublet with peaks of equal intensity and a quintuplet of peaks of intensities 1:4:6:4:1. Integrated line intensities of the doublet and quintuplet have a ratio of approximately 4:1. Nuclear spin coupling disappears at 115°C in IF_5 .¹⁵⁰

The enthalpy of formation of iodine pentafluoride was determined by Woolf¹⁵⁸ by calorimetric measurements of the heat of hydrolysis of the liquid and the heat of reaction with aqueous potassium hydroxide solution. The value has been updated by Cox⁸⁸, $\Delta H_{f298}^{\circ} \text{IF}_5(1) = -210.41 \pm 0.87 \text{ K.cal.mol}^{-1}$. This quantity has also been determined by Settle et.al.¹⁵⁹ using fluorine bomb calorimetry, deriving a value of: $\Delta H_{f298}^{\circ} \text{IF}_5(1) = -210.80 \pm 0.32 \text{ K.cal.mol}^{-1}$. Some other thermodynamic properties of IF_5 , including the heat capacity between 5° and 350°K, the enthalpy of fusion and vaporisation and the standard entropy of the vapour have recently been re-determined by Osborne, Schreiner and Selig¹⁶⁰. Other properties are listed by Stein¹¹⁰.

Iodine pentafluoride forms 1:1 adducts with SbF_5 ^{142,161} and PtF_5 ^{162,163}. An x-ray study has shown $\text{IF}_5 \cdot \text{SbF}_5$ to be of the form $\text{IF}_4^+ \text{SbF}_6^-$. The IF_4^+ has a structure like SF_4 with two fluorines occupying axial positions of a trigonal bipyramid and two fluorine atoms and a lone pair occupying the equatorial positions. The Raman spectrum of $\text{IF}_4^+ \text{SbF}_6^-$ has also been reported¹³². Nine lines were assigned to the IF_4^+ cation, which is consistent with the C_{2v} structure found from x-ray crystallography. The ^{19}F n.m.r. spectrum of $\text{IF}_4^+ \text{SbF}_6^-$ in IF_5 solution consists of a single line resonance¹⁶⁵.

Hexafluoroiodate salts, MIF_6 ($\text{M} = \text{K}, \text{Rb}, \text{Cs}$), have been prepared by a number of methods: (a) the reaction of the respective fluoride with an excess of boiling IF_5 ²⁸; (b) reaction of the respective iodide with an excess of boiling IF_5 ¹²⁹; and (c) tetraalkyl ammonium hexafluoroiodates were prepared from AgIF_6 ¹⁶⁶

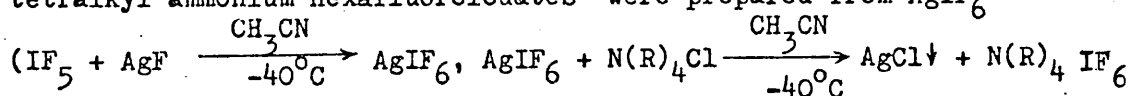

(R = Me, Et)).

The vibrational spectra of the IF_6^- ion has presented many problems. The infrared and Raman data were first published by two groups. Christe, Guertin and Sawodny¹⁶⁷ concluded that the IF_6^- ion was probably not octahedral, as is suggested for the BrF_6^- ion¹³². Klamm et. al.^{168,169} deduced from the spectra of various IF_6^- salts that C_{2v} was a possible symmetry and suggested two possible structures. Meanwhile, Christe's group, a Glasgow University group and an Argonne group published a joint paper¹⁷⁰ pointing out differences in the spectra they had obtained. They concluded that different solid phases must occur, depending on rather subtle differences in the methods of preparation, although no possible structures for any of the preparations could be suggested. A Mössbauer study¹⁷¹ was then reported which again concluded that the IF_6^- ion was not octahedral but could be C_{2v} for which a pentagonal bipyramid structure with the lone pair in an equatorial position was presented. The latest publication is again by Christe¹³⁴. He has found that alkali metal fluorides form both 1:1 and 1:3 adducts with IF_5 . Conversion from 1:3 to 1:1 takes place about 90° under vacuum. $\text{CsF} \cdot 3\text{IF}_5$ is stable and can be isolated, while $\text{Rb} \cdot \text{F} \cdot 3\text{IF}_5$ and $\text{KF} \cdot 3\text{IF}_5$ are not stable at room temperature. No evidence by differential thermal analysis or vibrational spectroscopy could be obtained for a 1:2 adduct as an intermediate in the decomposition of the 1:3. Thus, all previously reported spectra can be rationalised in terms of 1:1, 1:3 or mixtures of these two adducts. The incorrect analysis results were thought to be due to incomplete conversion of MF to $\text{MF} \cdot 3\text{IF}_5$ resulting in answers closely corresponding to MIF_6 . With this extra information the previous conclusions are confirmed that

the IF_6^- ion is not octahedral and does not possess a symmetry higher than C_{2v} .

The ^{19}F n.m.r. spectra of CsIF_6 and RbIF_6 in the molten state and in IF_5 solution both consist of single line resonances¹⁶⁵.

Iodine Heptafluoride, IF_7

During the preparation of IF_5 Ruff and Keim¹³⁸ noticed the presence of another more volatile fluoride. They found no evidence for the reaction between fluorine and iodine pentafluoride at 25°C but obtained the heptafluoride in good yield at $250^\circ\text{--}270^\circ\text{C}$. Schumb and Lynch¹⁷² have described an apparatus for preparing the compound from the elements and for purification by fractional sublimation. IOF_5 is a frequent impurity in IF_7 from the reaction with glass or moisture. Bartlett and Levchuk⁹⁵ recommend that the heptafluoride should be prepared from metal iodides, such as PdI_2 , rather than iodine, which is difficult to dry.

Iodine heptafluoride is a colourless gas which condenses to a white solid at 0°C . The solid sublimes at 4.77°C ¹¹⁰ and melts under its own vapour pressure forming a colourless liquid at 6.45°C ¹¹⁰. Until recently IF_7 was the only AB_7 type compound known; ReF_7 ^{173,174} and OsF_7 ¹⁷⁵ have since been prepared.

The infrared and Raman spectra of iodine heptafluoride were first investigated by Lord et.al.¹⁴³. They concluded that IF_7 has a pentagonal bipyramidal structure of D_{5h} symmetry. This conclusion appears to be correct, although it was based upon results obtained on samples contaminated with IOF_5 . The infrared and Raman spectra of gaseous samples of IF_7 have been re-examined by Claassen et.al.¹⁷⁶ who also inferred D_{5h} symmetry. The Raman spectra of IF_7 as a liquid and dissolved in liquid hydrogen fluoride have also been recorded¹⁷⁷. They closely resemble the gas phase

spectrum with no significant shift in the peak positions on going to the liquid.

Electron diffraction measurements have also been carried out on iodine heptafluoride. Bauer¹⁷⁸ first suggested that the two axial I-F bond were 1.94Å and the five equatorial were 1.83Å. On re-examination of the data LaVilla and Bauer¹⁷⁹ concluded that all seven bonds were approximately equal (I-F = 1.825Å), with the equatorial bonds not quite planar. More recent work by Thompson and Bartell¹⁸⁰ is consistent with D_{5h} symmetry and shows the axial bond distance to be shorter than the equatorial.

Equilibrium pressure measurements of the dissociation of IF_7 in the region 450-550°C have been reported by Bernstein and Katz¹⁸¹.

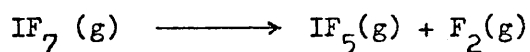

From these measurements and the enthalpy of formation of IF_5 a value for the enthalpy of formation of IF_7 can be calculated. The updated value given by Cox⁸⁸ is $\Delta H_{f298}^{\circ} IF_7(g) = -227.96 \pm 1.02 \text{ K.cal.mol}^{-1}$. A value of $\Delta H_{f298}^{\circ} IF_7(g) = -229.7 \pm 0.6 \text{ K.cal.mol}^{-1}$ has been derived from fluorine bomb calorimetry¹⁵⁹. Other thermodynamic properties are listed by Stein¹¹⁰.

No complexes of alkali metal fluorides with iodine heptafluoride are known and attempts at their preparation have proved unsuccessful¹⁷². However, adducts between IF_7 and fluorine acceptor compounds such as AsF_5 and SbF_5 have been reported by Seel and Detmer.^{182,183} They prepared the complexes $IF_7 \cdot AsF_5$ and $IF_7 \cdot 3SbF_5$ and postulated the ionic formulae to be $IF_6^+ AsF_6^-$ and $IF_4^{3+} (SbF_6^-)_3$. Christie and Sawodny¹⁸⁴ have commented upon the adduct between IF_7 and SbF_5 . They suggested that as the adduct of composition¹⁸³ $IF_7 \cdot 2.4SbF_5$ was also reported and as polymeric anions such as $Sb_2 F_{11}^-$ are known

the stoichiometry may be accidental and due to incomplete removal of SbF_5 . They suggested it may be interpreted in terms of IF_6^+ and polymeric $\text{SbF}_6^- \cdot x \text{SbF}_5$ rather than $\text{IF}_4^{3+} (\text{SbF}_6^-)_3$.

The vibrational spectra of the adduct $\text{IF}_7 \cdot \text{AsF}_5$ ¹⁸⁴ indicate that it has an ionic structure, $\text{IF}_6^+ \cdot \text{AsF}_6^-$, in the solid state and that the IF_6^+ cation is present in an octahedral configuration of O_h symmetry. Assignments were made and force constants calculated for the cation. The white crystalline solid was found to have a dissociation pressure at room temperature; the infrared spectrum of the gas phase showed the complex to be completely dissociated. From temperature pressure measurements an enthalpy of dissociation could be calculated. Other thermodynamic properties were also derived including the enthalpy of formation,

$$\Delta H_{f298}^\circ [\text{IF}_6^+ \text{AsF}_6^- (\text{s})] = -538 \text{ K. cal. mol.}^{-1}.$$

Some of the assignments made for the IF_6^+ cation were later questioned by Leroi and Hardwick¹⁸⁵. In reply Christie and Sawodny¹⁸⁶ presented further arguments for their original assignments. These were later proved to be correct from polarisation measurements¹⁸⁷ on the Raman spectrum of $\text{IF}_6^+ \text{AsF}_6^-$ in liquid hydrogen fluoride solution. A Mössbauer study¹⁷¹ has also confirmed the octahedral symmetry of the IF_6^+ cation.

Two broad-line n.m.r. studies of solid $\text{IF}_6^+ \text{AsF}_6^-$ have been reported. The ^{19}F , ^{75}As and ^{127}I resonances have all been observed at room temperature¹⁸⁸. The ^{19}F spectrum at a 4 KG (17MHz) field strength featured two broad overlapping peaks. A more detailed study¹⁸⁹ at frequencies up to 94.1 MHz showed resolved peaks for fluorine in AsF_6^- and in IF_6^+ . The ^{19}F n.m.r. spectrum of $\text{IF}_6^+ \text{AsF}_6^-$ has also been investigated in liquid hydrogen fluoride

solutions¹⁷⁷. The IF_6^+ peak was observed as a sextet with components of approximately equal height. The measurement of the chemical shift and the first direct measurement of an iodine-fluorine coupling constant ($J_{\text{I-F}}$) were taken.

SECTION II

RESULTS AND DISCUSSION

II - A. Spectroscopic Properties

To aid the assignment of the iodine oxygen fluorine compounds discussed in this section the vibrational frequencies of some related compounds, which have been previously assigned, are listed in table II-A 1. The mode labels (e.g. I-F stretch, O - I - O deformations) are not intended to suggest that the particular mode is accurately described but the table is intended to give an approximate representation of the regions of the spectrum in which a particular mode is expected.

Iodine-oxygen and iodine-fluorine stretches are seen to occur in the regions 900 - 750 and 700 - 550 cm^{-1} respectively.

Angle deformations may be expected in the region 400 - 200 cm^{-1} .

Table II - A. 1

Vibrational Frequencies of Iodine Compounds (cm^{-1})

Compound	I - F stretches	F - I - F deformations	I - O stretches	O - I - O deformations	References
IF_5	698,640 593,575	374,315 273,257,189	-	-	143-147
IF_7	746,676 635,510	425,365 352,310,257	-	-	143,176
IOF_5	710,680 640,640	369,360,342* 305,275,205	927	-	31
IO_3^-	-	-	774,754	373,355	190,191
IO_4^-	-	-	853,791	325,256	192

* (F - I - O deformation)

Dioxodifluoroiodate Salts., MIO_2F_2

The infrared and Raman spectra of dioxodifluoroiodate salts, MIO_2F_2 ($\text{M} = \text{Na}, \text{K}, \text{Rb}, \text{NH}_4$) are recorded in table II - A.2. and shown in figures II - A.1. and II - A.2. The low frequency infrared modes of KIO_2F_2 were also recorded by interferometry as polythene discs.

Table II - A.2.

Infrared and Raman Spectra of Dioxodifluoroiodate Salts (cm^{-1})

NaIO_2F_2		KIO_2F_2		RbIO_2F_2		$\text{NH}_4\text{IO}_2\text{F}_2$	
I.R.	R	I.R.	R	I.R.	R	I.R.	R
860(s)	862(w)	851(m)		850(m)		844(m)	
		845(w)	838(w.sh)	842(w.sh)	840(w.sh)	835(w)	830(w.sh)
835(s)	834(v.s)	819(s)	817(v.s)	818(s)	819(v.s)	815(s)	815(v.s)
	803(w)	805(s)	804(w.sh)	803(s)	808(w.sh)	790(s)	797(v.s)
450(m)	467(m)	485(s)	479(m)	475(s)	477(m)	490(s)	486(m)
420(s)		440(s)	456(w.sh)	427(s)		425(s)	
		407(m)		399(m)			
378(s)	396(m)	360(m)	360(m)	353(w.sh)	352(m)	348(s)	354(m)
		351(w.sh)		347(m)			
330(w)	331(m)	345(s)	346(w.sh)	337(m)	341(w.sh)		
	296(m)		323(s)		316(m)		323(m)
220(m)		220(w)		216(m)			215(w)
195(m)	199(w)	197(m)	194(w)	190(m)	192(w)	194(m)	194(w)

Key to tables in this section: v, very; s, strong; m, medium;
w, weak; br, broad; sh, shoulder.

FIGURE: II-A.1 INFRARED SPECTRUM OF POTASSIUM DIOXIDIFLUORODATE (KIO₂F₂)

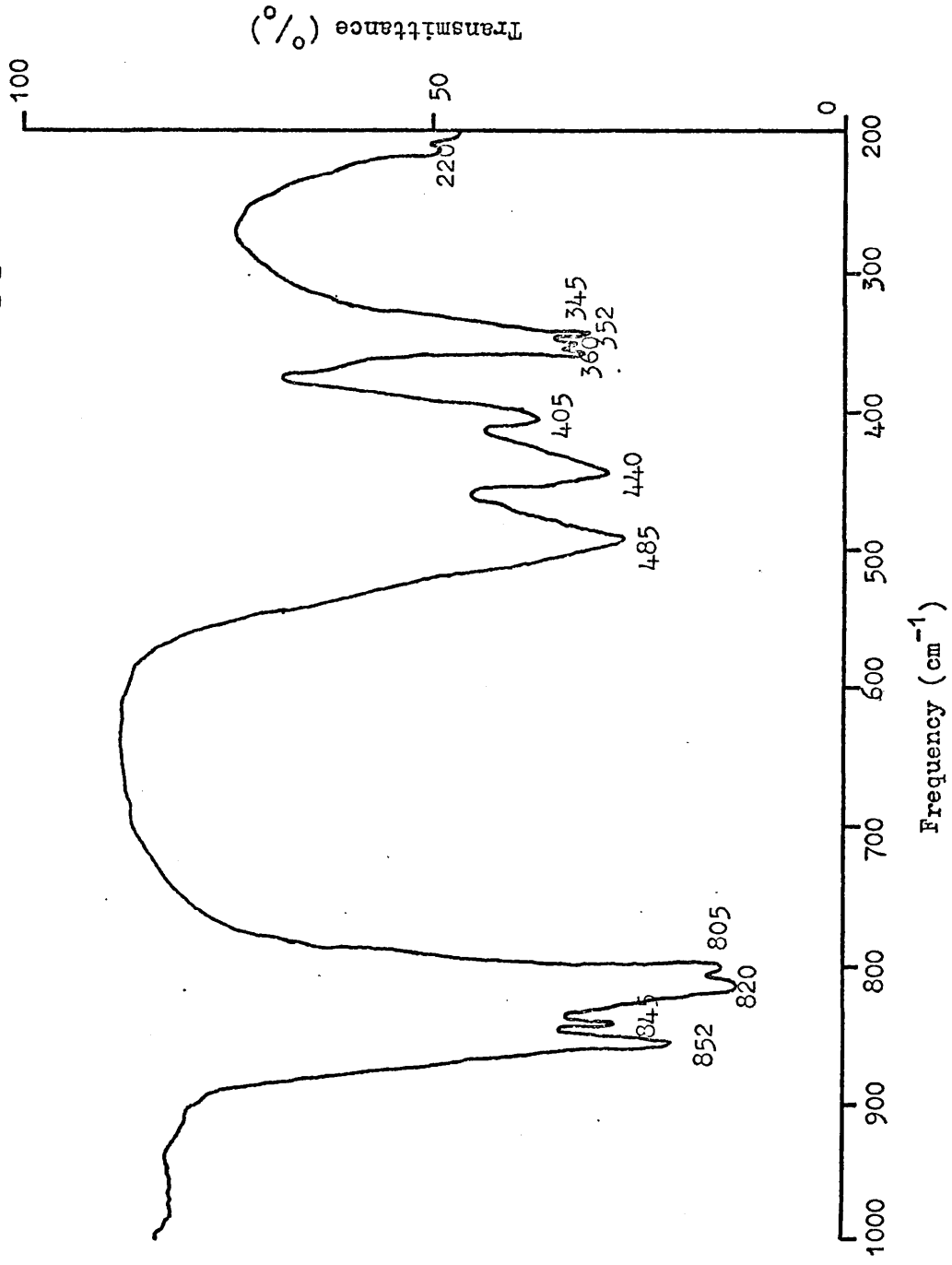
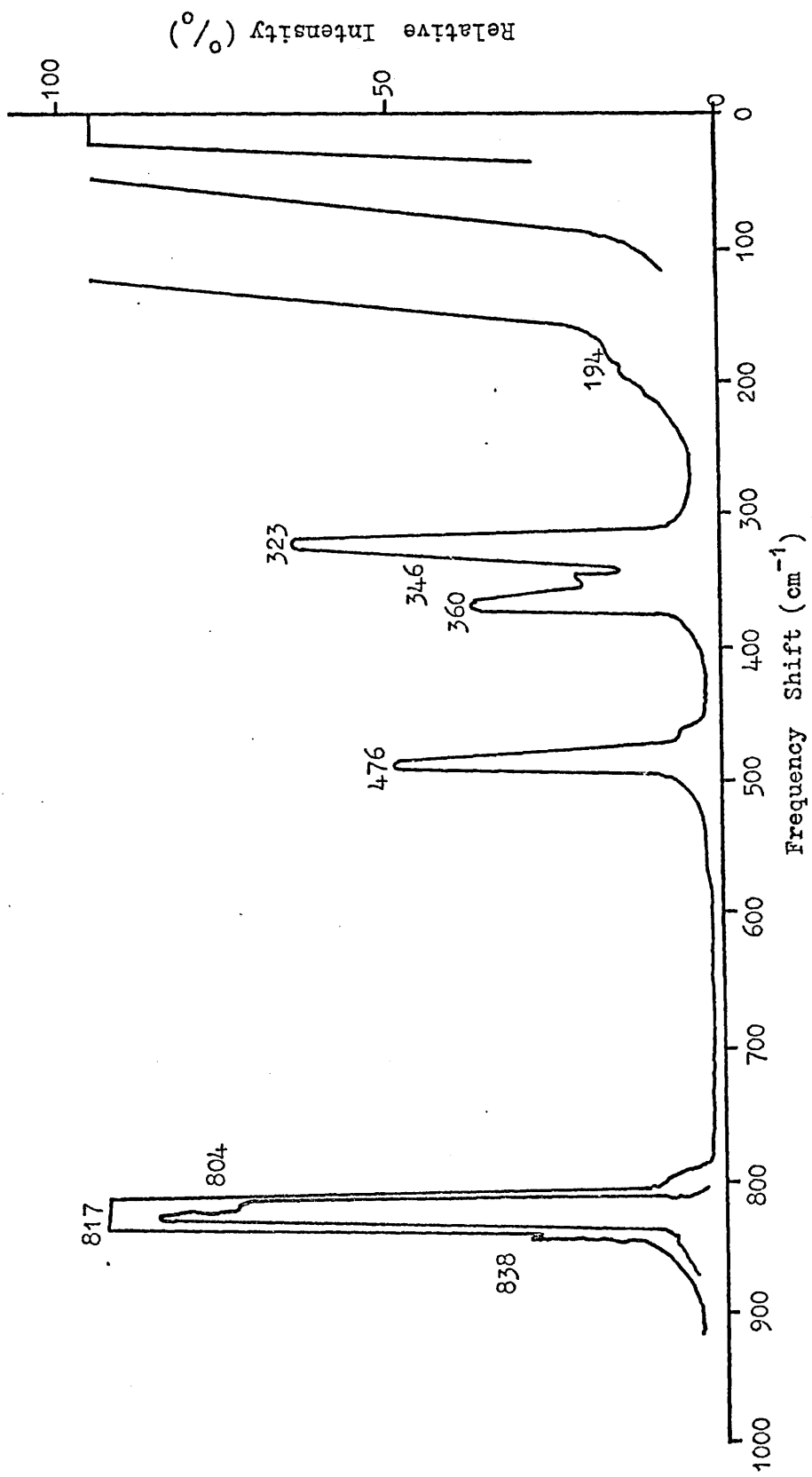

FIGURE: II-A.2 RAMAN SPECTRUM OF POTASSIUM DIOXODIFLUOROIODATE (KIO₂F₂)



The structure of KIO_2F_2 has been determined by x-ray diffraction studies⁴. The anion has a trigonal bipyramidal structure with the fluorine atoms occupying the axial positions and the oxygen atoms and the electron pair the equatorial positions. This structure would belong to the C_{2v} point group and the normal modes can be classified as follows:

$$4a_1 + a_2 + 2b_1 + 2b_2$$

the a_1 , b_1 and b_2 modes being active in both infrared and Raman and the a_2 mode active in the Raman only.

The vibrational spectrum of KIO_2F_2 and assignments are given in table II - A.3. and compared with those of the isoelectronic molecule XeO_2F_2 ²² and the related ClO_2F_2 ¹⁹. The I - O stretching modes in KIO_2F_2 have been assigned to the bands at 851 cm^{-1} and 817 cm^{-1} , the higher frequency being the antisymmetric stretch ν_8 (b_2) which is expected to be weak in the Raman and has not been observed. It can be seen that ν_1 (a_1) is split into three components. This splitting was also observed¹⁹ in ClO_2F_2^- . The I - F stretching modes are assigned to the bands at 479 cm^{-1} and 440 cm^{-1} . The antisymmetric stretch ν_6 (b_1) is expected to be weak in the Raman and thus has been assigned to the lower frequency fundamental. An antisymmetric stretch ($X = \text{Cl}, \text{Xe}$) at a lower frequency than the symmetric was also concluded for ClO_2F_2^- ¹⁹ while the more normal reverse order was concluded in the spectra of XeO_2F_2 ²². The symmetric bending modes of O - I - O and F - I - F (ν_3 (a_1) and ν_4 (a_1)) are expected to be fairly strong in the Raman and only weak in the infrared. These have thus been assigned to the bands at 323 cm^{-1} and 190 cm^{-1} . The antisymmetric bending fundamentals (ν_7 (b_1) and ν_9 (b_2)) have been assigned to the 346 cm^{-1} and 360 cm^{-1} bands, both of which are fairly

Table II - A.3.

Assignment of the Vibrational Spectrum of $K^+IO_2F_2^-$
 compared to those of XeO_2F_2 and $Cs^+ClO_2F_2^-$

$K^+IO_2F_2^-$ (cm^{-1})		XeO_2F_2 ²² (cm^{-1})		$Cs^+ClO_2F_2^-$ ¹⁹ (cm^{-1})		Assignment (point group C_{2v})
I.R.	R	I.R.	R	I.R.	R	
851(m)		905(s)	902(w)	1225 } 1191 }	1221(0.8)	$\nu_6(B_1)$
				(v.s)		
845(w)	838(w.sh)				1076(10)	
819(w)	817(v.s)	848(m)	845(v.s)	1070(s)	1064	$\nu_1(A_1)$
805(s)	804(w.sh)				1055	
485(s)	479(m)		490(s)	559(m)	559(1.2)	$\nu_2(A_1)$
440(s)	456(w.sh)	585(v.s)	578(w)	510(v.s.br)		$\nu_8(B_2)$
360(m)	360(m)	317(m)	313(m)		363(10)	$\nu_9(B_2)$
345(s)	346(w.sh)	324(s)		330-370(m)	337(8)	$\nu_7(B_1)$
	323(s)		333(m)		337(8)	$\nu_3(A_1)$
220(w)			223		480(1)(br)?	$\nu_5(A_2)$
197(m)	194(w)		198(w)		198(0.7)	

intense in the infrared. The remaining fundamental $\nu_5(a_2)$ has been tentatively assigned to the infrared band at 220cm^{-1} .

This band is forbidden in the infrared and allowed in the Raman, where it is expected to be weak. However, it would not be surprising if it could be observed in the infrared spectrum of the solid where crystal field effects can disturb the selection rules. The assignment of the deformation bands of KIO_2F_2 must be considered tentative and do vary from those of Carter and Aubke⁸.

Solution Raman studies to aid the above assignments were also attempted. The only solvent found in a sufficient quantity of solute would dissolve was aqueous hydrofluoric acid (48%). Strong background scattering in the Raman spectrum, however, made the identification of any features impossible.

It can be seen from table II - A.2. that a shift in the fundamental frequencies occurs in the IO_2F_2^- ion with changing cation, the most marked shift being from sodium to potassium. Generally, although some modes are more sensitive to cation change than others, the highest frequency of an anion is found when it is associated with the smallest cation. Work done by Adams and Morris^{190,191} using the anions $[\text{Pt Cl}_6]^{2-}$, $[\text{Pt Br}_6]^{2-}$, $[\text{Sn Cl}_6]^{2-}$ and $[\text{Pb Cl}_6]^{2-}$ clearly shows this trend. However, for the IO_2F_2^- ion the I - O stretching modes do increase with the smaller cation but the I - F stretching modes appear to decrease. The reason for this partial reversal of the general trend is probably due to the highly electronegative nature of fluorine. The I - F bonds are already expected to be weak as the formal negative charge would be distributed mainly over the fluorine atoms. The smaller sodium cation,

with a greater charge density, could further polarise the charge on the fluorines giving the I - F bonds a greater ionic contribution and increasing the double bond character of the I - O bonds.

Approximate force constants have been calculated for the IO_2F_2^- ion employing a computer programme devised by Dr. D. Steele of this Department. The object of this exercise was simply to give a very approximate indication of the magnitude of the stretching force constants and as a guide to the assignment of the normal modes. Thus, no exhaustive efforts were made to obtain an exact fit between the observed and calculated frequencies, nor were any interaction force constants (non-diagonal F matrix terms) used. The B matrix elements were computed directly from a set of cartesian co-ordinates obtained from the x-ray study of Helmholtz and Rogers⁴. The approximate magnitude of the stretching force constants of IO_2F_2^- are listed in table II - A.4. together with those of related species.

Before comparing the stretching force constants of IO_2F_2^- with other species the approximate nature of these calculations must be stressed. From table II - A.4. it can be seen that the iodine-oxygen stretching force constant for the IO_2F_2^- ion is lower than the value derived for the doubly bonded iodine-oxygen bond of IOF_5 but is higher than those obtained for other iodine-oxygen ions. This result suggests the presence of partial double bond character. The value of the iodine-fluorine stretching force constant is lower than any yet obtained for an iodine-fluorine compound. Both these results are consistent with the expected effect of the highly electronegative fluorine atoms, as has been discussed before.

The nuclear magnetic resonance spectrum of KIO_2F_2 dissolved in HF (48%) showed just one broad resonance peak slightly displaced upfield

from the original position of the neat solvent. All resonances were measured from an external reference of trifluoroacetic acid. This result suggests that fluorine exchange is taking place between the solvent and the solute producing just on time-average resonance peak.

Table II - A.4.

Approximate Stretching Force Constants of
Iodine Compounds. (millidynes /Å)

Compound	f (I - O)	f (I - F) _{ax}	f (I - F) _{eq}	Reference
IO_2F_2^-	5.7	2.3	-	this work
IOF_3	6.55	2.7	4.1	this work
IOF_5	6.99	4.66	4.42	31
IF_5	-	4.60	3.64	144
IF_7	-	4.36	3.55	193
IO_3^-	4.6	-	-	194
IO_4^-	5.0	-	-	195

Iodine Oxide Trifluoride, IOF₃

The Raman spectrum of IOF₃ is recorded in table II - A.5 and figure II - A.3. No satisfactory infrared spectrum could be obtained due to the reactivity of the solid although attempts were made with various mulling agents and plates. The spectrum obtained in this work agrees well with that reported by Carter and Aubke⁸ although any iodyl fluoride impurity has been eliminated and the lower frequency regions are now more detailed.

The structure of IOF₃ was found by x-ray studies to be a distorted trigonal bipyramid with two fluorine atoms in the axial positions and the third fluorine atom together with the oxygen atom and the non-bonding electron pair in the equatorial positions. This structure would thus give the Cs point group and the normal mode of which can be classified as follows :

$$6A^1 + 3A^{11}$$

These modes are all active in both the infrared and Raman.

The nine fundamentals of IOF₃ have been observed in the Raman spectrum. The assignment of this spectrum, however, is made more difficult without any infrared data. The stretching modes may be assigned with some degree of certainty but insufficient data precludes any assignment of the deformation modes. The I - O stretching fundamental has been assigned to the strong band at 883 cm⁻¹. It can be seen that splitting has again occurred in the iodine-oxygen stretching region of the Raman spectrum as has been noticed for the IO₂F₂⁻ ion. The band at 656 cm⁻¹ has been assigned to the I - F stretching mode of the equatorial fluorine. The bands at 549 cm⁻¹ and 513 cm⁻¹ are thus attributed to the I - F stretches of the axial fluorines, the antisymmetric stretch is expected to be

FIGURE: II-A.3 RAMAN SPECTRUM OF IODINE OXIDE TRIFLUORIDE (IOF₃)

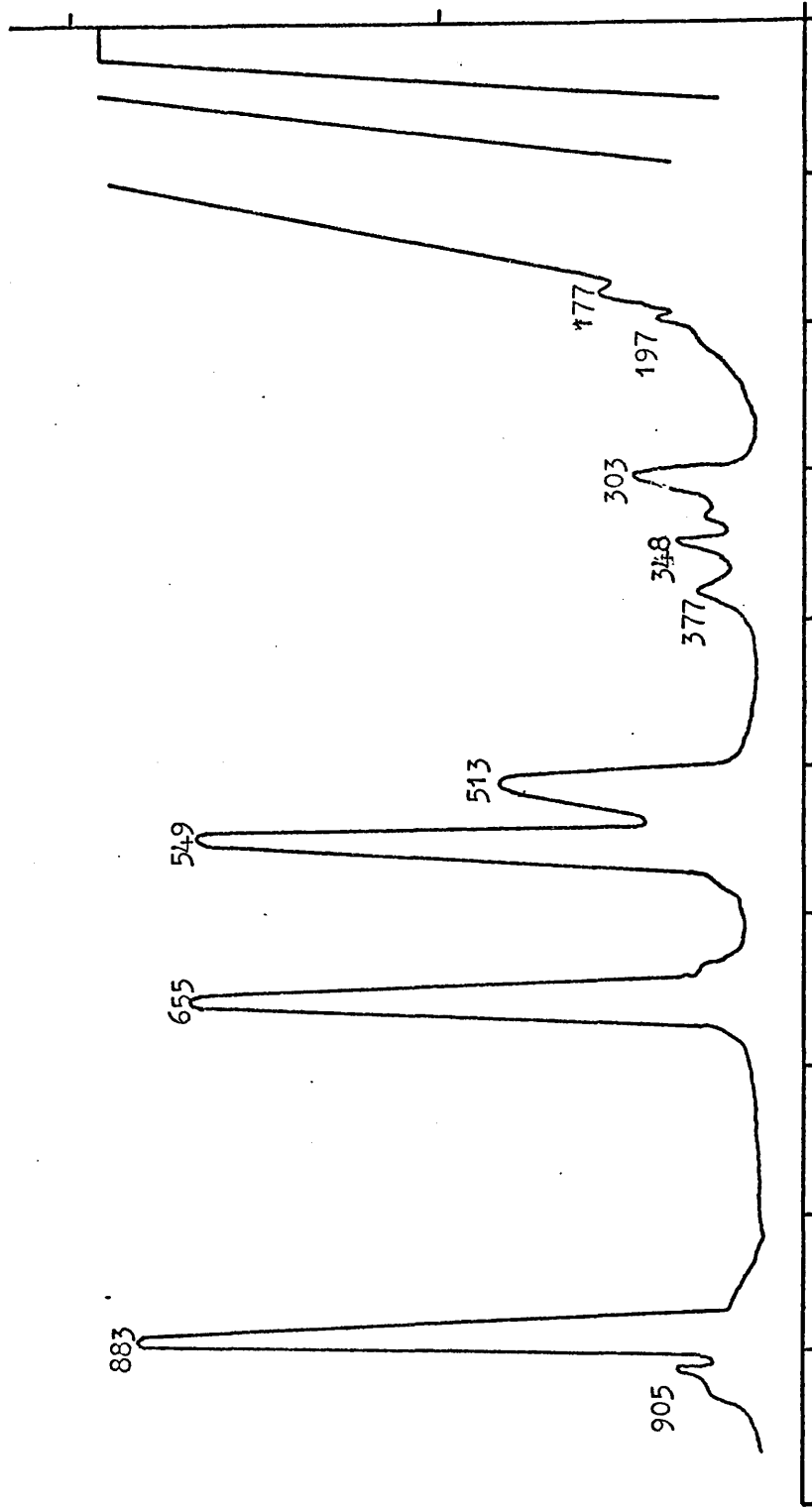

Table II - A.5.

Raman Spectrum of Iodine Oxide Trifluoride
with Assignments

Raman (cm^{-1})	Assignments	Approx.description of vibration
906 (w)	$\nu_1(A^1)$	
884(v.s)		
862(w)		
656(v.s)	$\nu_2(A^1)$	$\nu(\text{IF})_{\text{eq.}}$
549(v.s)	$\nu_3(A^1)$	$\nu(\text{IF})_{\text{ax.}}$
513(m.s)	$\nu_7(A^{11})$	$\nu(\text{IF})_{\text{ax.antisym.}}$
377(w)		
348(m)		
326(w)		
303(m)		
216(w)		
196(w)		
177(m)		

weak and is thus assigned to the lower fundamental frequency.

Force constant calculations have been carried out for IOF_3 by the same procedure outlined for IO_2F_2^- . The cartesian co-ordinates were calculated from the structure derived from the x-ray studies of Viers and Baird^{29,30}. The very approximate stretching force constants obtained from the normal co-ordinate analysis are listed in table II - A.4.

From table II - A.4. it can be seen that the magnitude of the iodine oxygen stretching force constant, $f(\text{I} - \text{O})$, of IOF_3 is appreciably higher than the value obtained for the IO_2F_2^- ion and approaches that of IOF_5 . The two iodine fluorine stretching force constants of IOF_3 are again higher than the corresponding value derived for the IO_2F_2^- ion. However, the axial iodine fluorine stretching force constant is lower than for other iodine fluorine compounds indicating weaker bonds. These observations may be rationalised by two possible explanations. The removal of the negative charge in IOF_3 compared with IO_2F_2^- will be expected to increase the strength of the I - F bonds by decreasing their ionic contribution. The comparative weakness of the axial I - F bonds may be due to the existence of an I - O bond. Christie¹⁹ has found for chlorine oxygen fluorine compounds that substitution of an oxygen atom for fluorine weakens the remaining Cl - F bonds. This observation appears to be correct in this case for iodine oxygen fluorine compounds.

Nuclear magnetic resonance studies of IOF_3 dissolved in iodine pentafluoride have been undertaken in an attempt to determine the structure of the molecule in solution. The spectra of an approximately 1M solution at varying temperatures are shown in figure II - A.4. It can be seen that at the higher temperatures

used (60-90°C) the fine structure of IF_5 becomes increasingly obscured. As the temperature is decreased the two peaks of the equatorial and axial fluorines of IF_5 resolved into a doublet of equal intensity and a quintuplet of peaks of approximate intensities 1 : 4 : 6 : 4 : 1 in the ratio of about 4 : 1 respectively. At progressively lower temperatures a single small peak was seen to move downfield from the doublet peak of IF_5 . This peak was attributed to the dissolved IOF_3 . In order to resolve this peak into its possible components the lowest possible temperatures were used. However, when approaching 0°C the solvent started to freeze with no apparent resolution of the IOF_3 peak having taken place. Measurements of the chemical shifts, from the mid-point of the doublet peak of IF_5 , of the peak due to IOF_3 were taken at 20°C (13.7 p.p.m.) and 6°C (15.6 p.p.m.) and are shown in figure II - A.4. It should also be noted that at temperatures above room temperature fluorine exchange occurs principally between those of IOF_3 and the equatorial positions of IF_5 .

FIGURE: II-A.4 VARIABLE TEMPERATURE N.M.R. SPECTRA
OF A 1M SOLUTION OF IOF_3 IN IODINE PENTAFLUORIDE

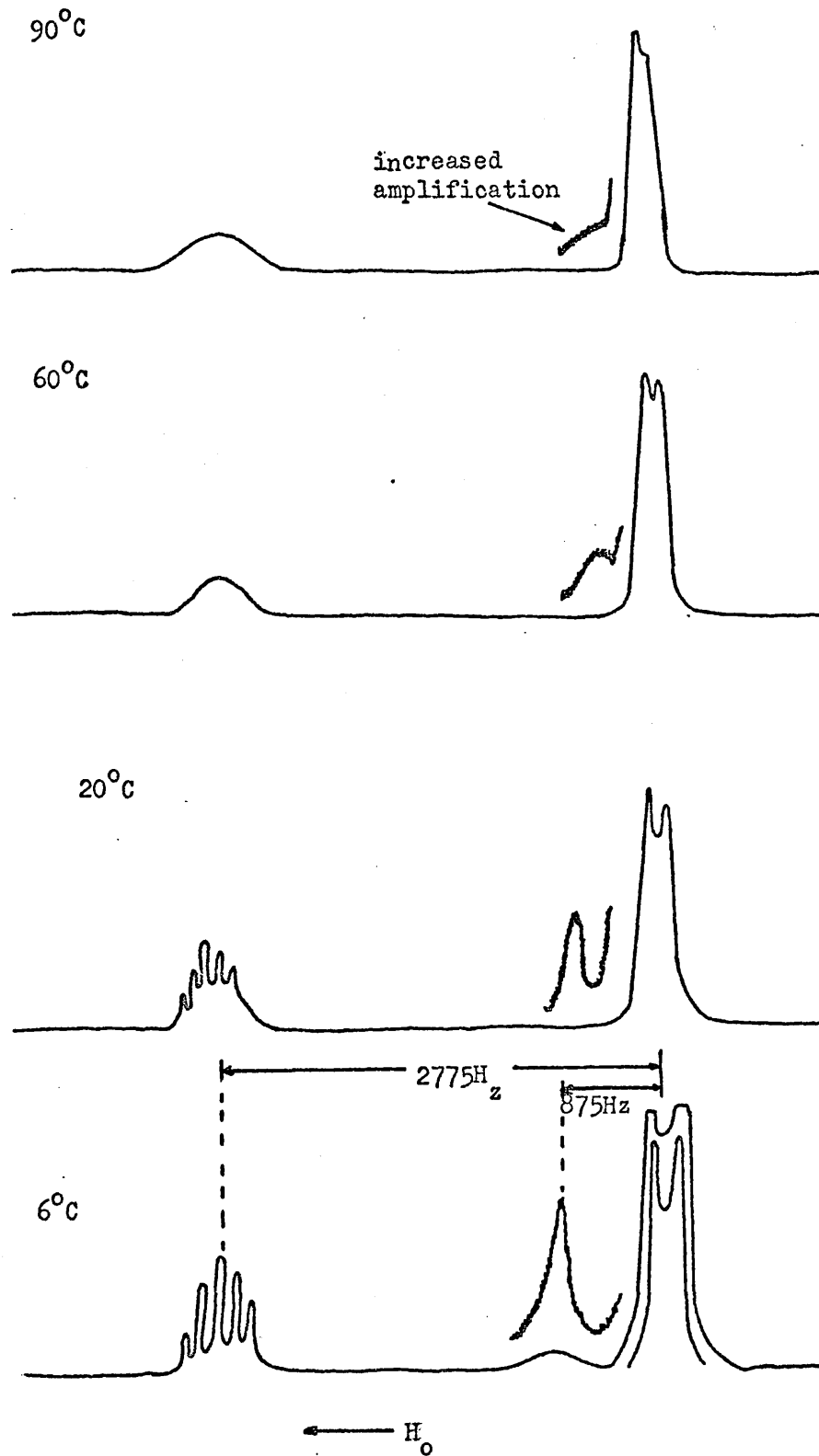

Iodyl Fluoride, IO₂F

The infrared and Raman spectra of iodyl fluoride are recorded in table II - A.6. and shown in figures II - A.5. and II - A.6. These spectra agree well with the previously published data^{8,36}.

The structure of iodyl fluoride is not known. However, the related chloryl fluoride, ClO₂F, is known to possess a pyramidal structure of Cs symmetry. Figure II - A.7. shows the Raman spectrum of chloryl fluoride published by Smith et. al.³⁷ It is apparent when comparing the spectra of IO₂F with ClO₂F, in figures II - A.5. and II - A.6., that the former exhibits a far more complex spectrum than the latter. This complexity thus leads to the conclusion that iodyl fluoride does not exist in a simple monomeric formulation similar to chloryl fluoride.

The strong bands at 807 cm⁻¹ in the Raman and 836cm⁻¹ in the infrared spectra of iodyl fluoride can be assigned to the iodine-oxygen stretching modes. Also, the strong bands at 551 cm⁻¹ in the Raman and at 558 cm⁻¹ and 534 cm⁻¹ in the infrared have been assigned to the iodine-fluorine stretching fundamentals. Thus, the remaining intense bands in the stretching region of the spectrum are at 720 cm⁻¹ in the infrared and 706 cm⁻¹ in the Raman. The broad profile of this infrared band is consistent with that expected for a polymeric structure, as indicated from the complex spectra. The possible polymeric structures of iodyl fluoride would involve association either through the fluorines or the oxygens. This association is probably through the oxygens rather than the fluorines due to the apparent existence of iodine fluorine stretching

Table II - A.6.

Vibrational Spectrum of Iodyl Fluoride

Raman (cm^{-1})	Infrared (cm^{-1})	Approximate Assignments
864(w)	860(m)	I - O str.modes
834(w.sh)	836(s)	
807(v.s)	803(m)	
706(s)	720(s)	
551(v.s)	554(s)	I - F str.modes
537(w.sh)	534(m)	
364(w)	360(m)	deformations
347(w.sh)	342(m.s)	
329(m.s)	331(m)	
308(w)	307(m)	
254(m)	261(m)	
174(w)		
144(w)		
122(m)		
110(m)		
68(w)		

FIGURE: II-A.5 INFRARED SPECTRUM OF IODYL FLUORIDE.

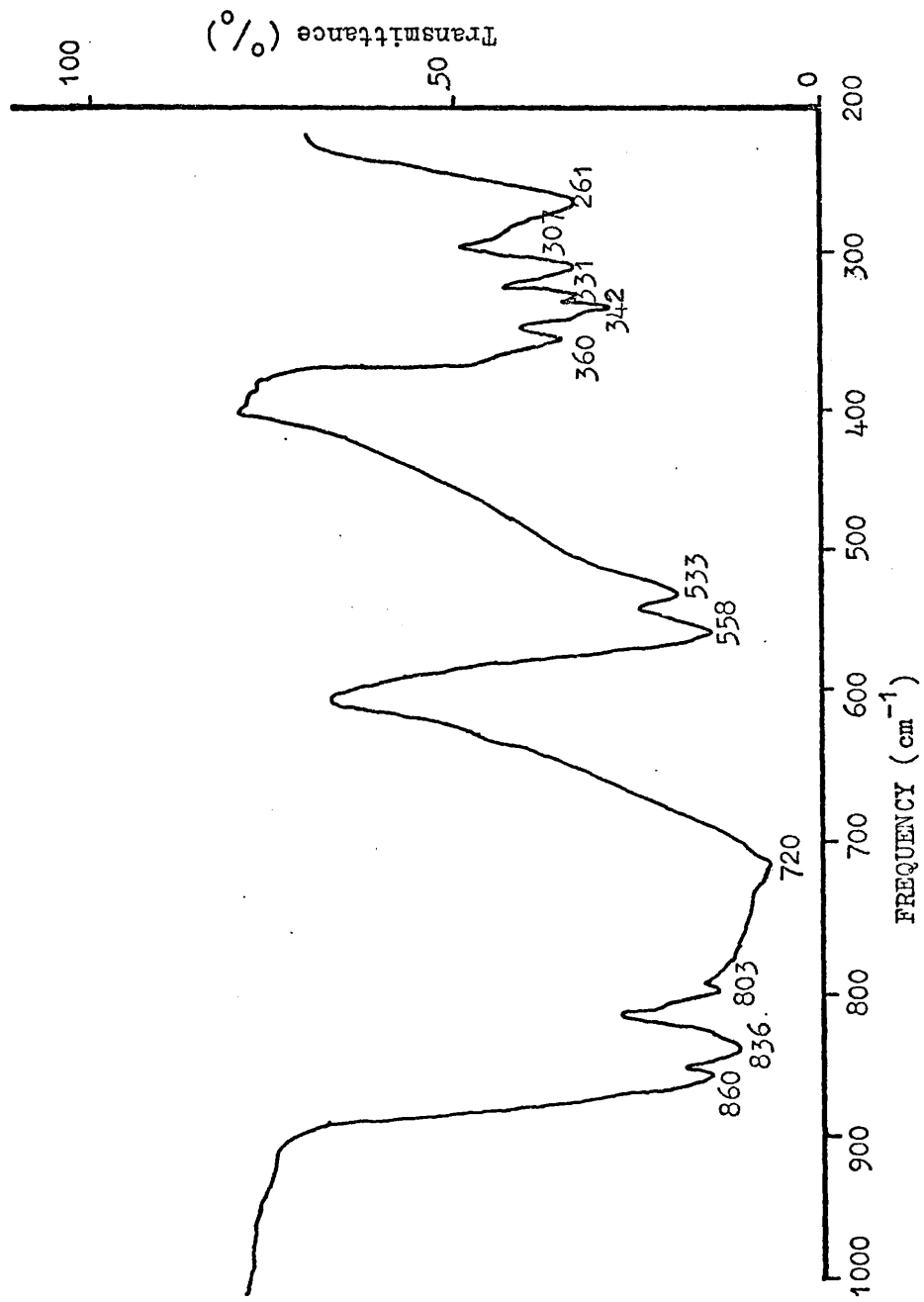

FIGURE: II-A.6 RAMAN SPECTRUM OF IODYL FLUORIDE.

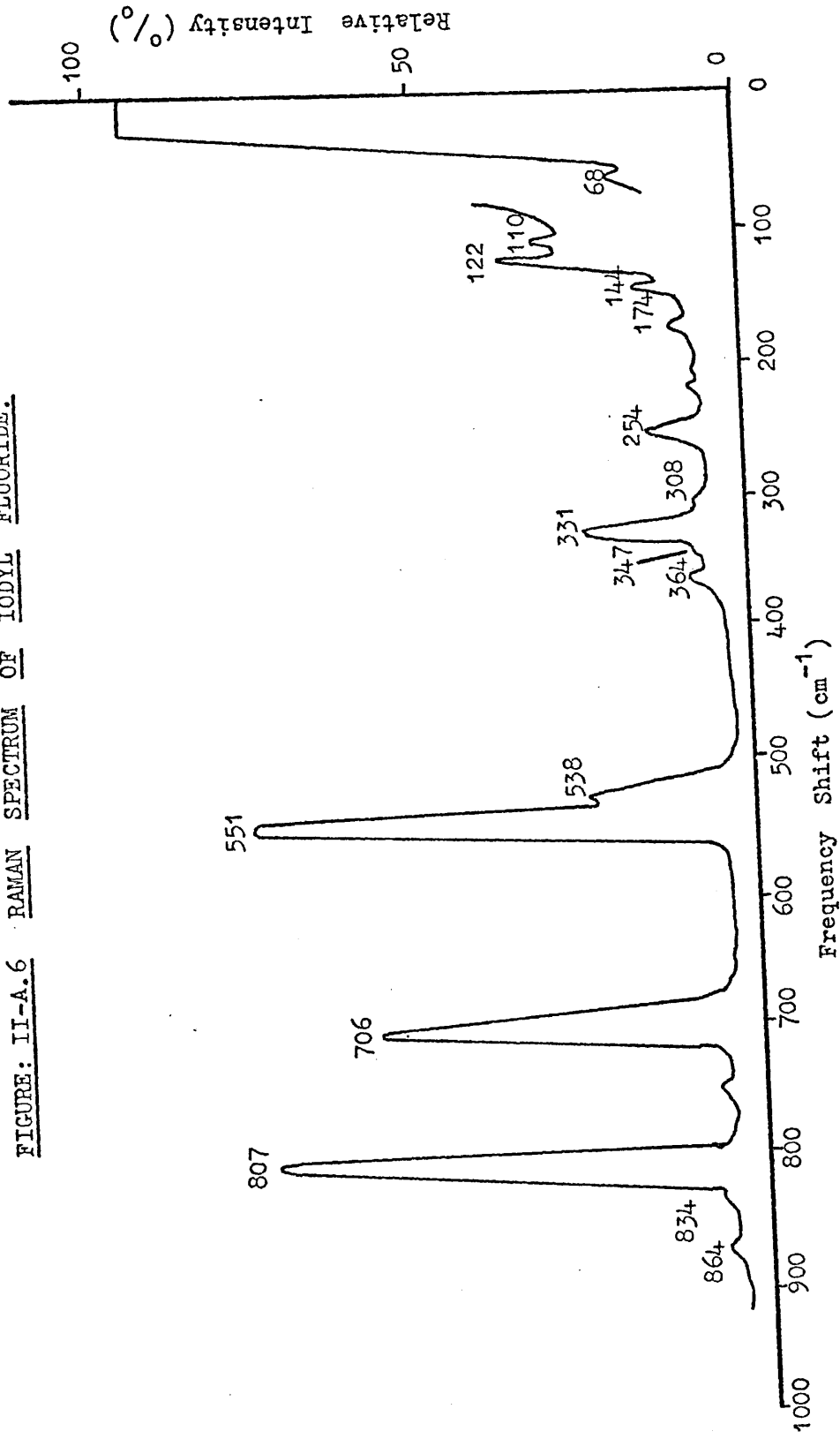
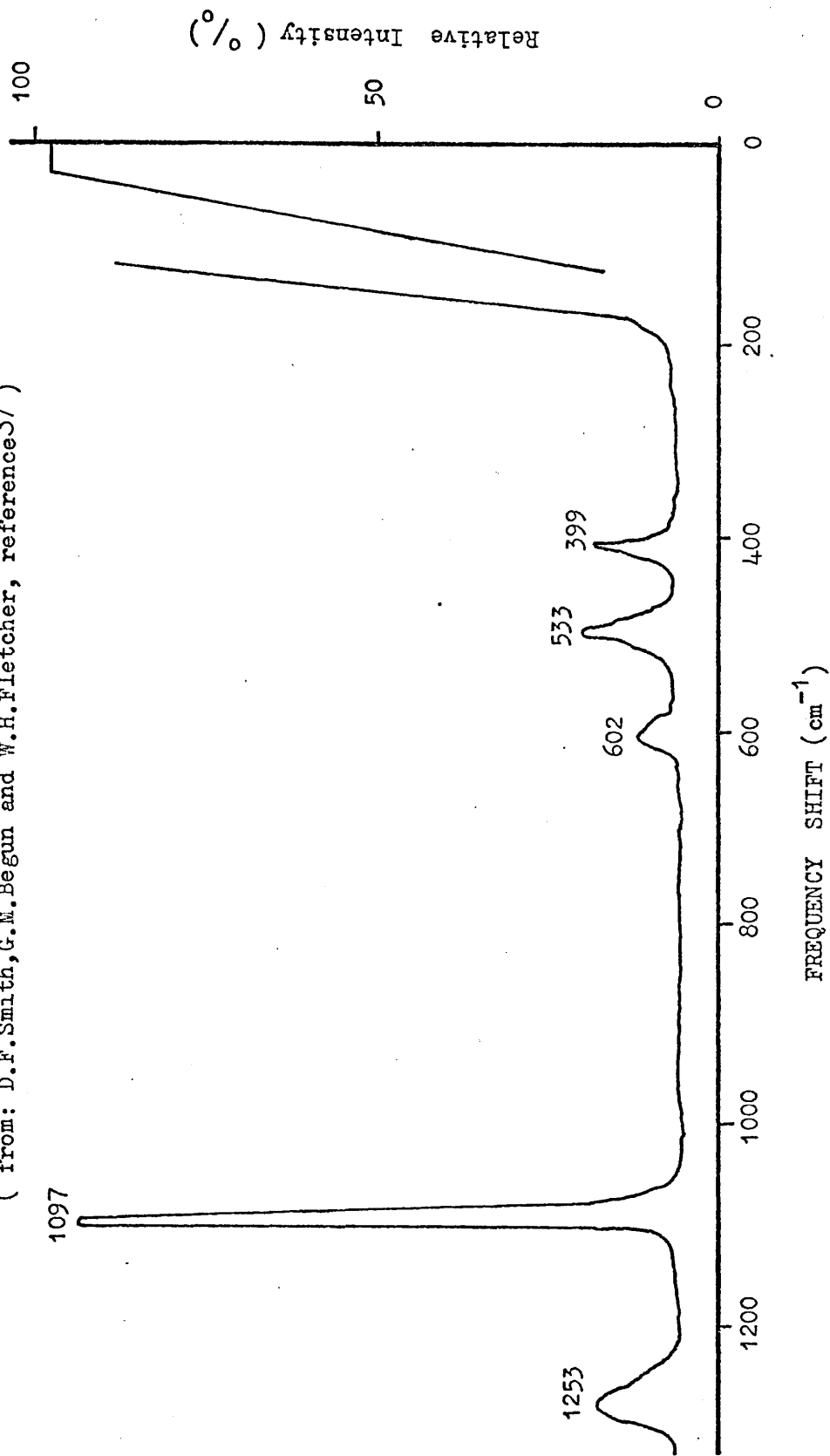

FIGURE: II-A.7 RAMAN SPECTRUM OF CHLORYL FLUORIDE (ClO₂F)*

* (from: D.F.Smith, G.M.Begun and W.H.Fletcher, reference 37)



fundamentals. Three possible polymeric structures are shown below in figure II - A.8.

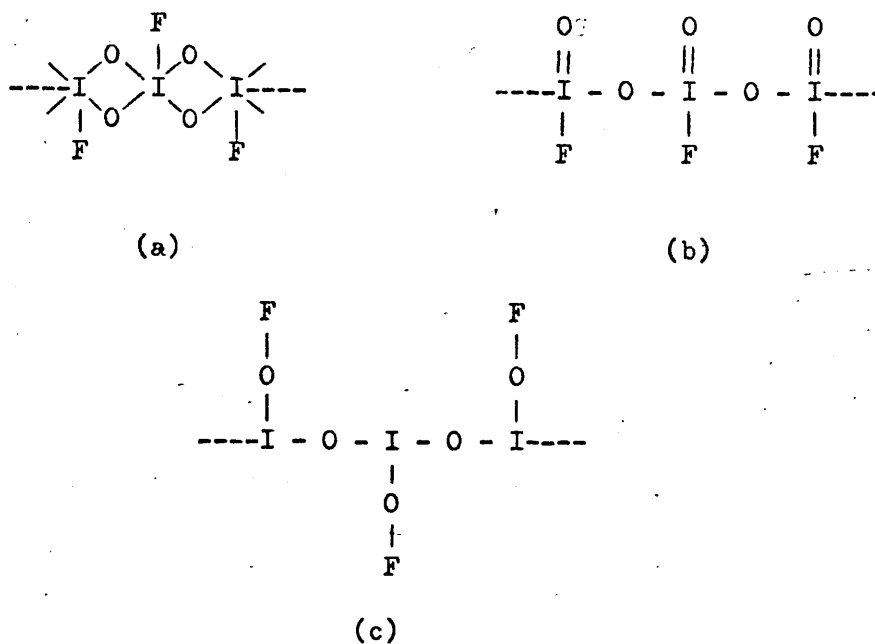

Figure II - A.8.

Structures (a) and (c) do not contain any double-bonded iodine oxygen bonds, which are indicated from the vibrational spectrum, and thus appear unlikely. Structures (b) and (c) contain - O - I - O - I - chains. This type of polymeric structure has been found in the compounds $(IO)_2SO_4$ and $(IO)SeO_4$ ¹⁹⁶. The iodine oxygen stretches in these compounds were assigned to vibrational frequencies in the region $550 - 660 \text{ cm}^{-1}$. Assuming these type of polymeric chains exist in iodyl fluoride then the symmetric stretching mode of the iodine oxygen linkages must be assigned to the infrared band at 720 cm^{-1} and the Raman band at 706 cm^{-1} .

An infrared spectrum of periodyl fluoride, IO_3F , has been published by Paul et. al.⁷⁰ The pattern of the spectrum is very

similar to that obtained for iodyl fluoride. A structure analogous to (a) of figure II - A.8. with an additional doubly-bonded oxygen atom attached to each iodine atom was concluded from the spectrum. However, although this structure would seem reasonable from the observed spectrum some of the assignments made are incorrect. The iodine fluorine stretching fundamentals were assigned by comparison with the vibrational spectrum of IF_7 recorded by Lord et. al.¹⁴³ However, the sample of IF_7 is now known to have been contaminated with IOF_5 . Paul et. al.⁷⁰ have made no reference to the later IF_7 studies of Claassen et. al.¹⁷⁶ They thus assigned the iodine fluorine stretch of IO_3F to a band in the region of the spectrum in which the iodine oxygen stretching fundamental of the contaminant IOF_5 occurred. Although some of the assignments made by Paul et. al. are incorrect, a frequency of either 650 cm^{-1} or 716 cm^{-1} can be assigned to the symmetric I - O - I stretch either of which would be close to that assigned for iodyl fluoride.

In addition to the polymers already suggested the structure of iodyl fluoride could possibly involve that of the dimer type shown in figure II - A.8. This structure could also account for the stretching fundamentals observed in the vibrational spectrum but is unlikely due to the complete lack of volatility.

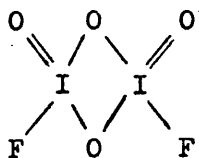

Figure II - A.9.

In an attempt to determine if a dimer could exist in iodyl fluoride the mass spectrum was taken. Two spectra were recorded, one at a temperature higher than the stated decomposition temperature of 220°C²⁵ and one below. The first spectrum was recorded with a sample temperature of approximately 230°C. The strongest peak obtained was at a mass to charge ratio (m/e) of 254 mass units, this being due to the ion I_2^+ . This peak would be expected to be strong as iodyl fluoride is known to decompose at this temperature to iodine²⁵. Strong peaks were also obtained for m/e ratios corresponding to the following species: IF^+ , IF_2^+ , IF_3^+ , IF_4^+ (strongest of the series), IF_5^+ . Smaller peaks were also seen due to: IOF^+ , IOF_2^+ , IO_2^+ , I^+ (or I_2^{2+}) and IO_2F^+ . There was no trace of a peak at $m/e = 356$ mass units which would be due to the dimeric molecular ion. A second spectrum was then taken at a sample temperature of approximately 170°C. However, the features obtained were almost identical to those at the higher temperature. The peak due to I_2^+ was again the strongest peak obtained. The series IF^+ , IF_2^+ , IF_3^+ , IF_4^+ (strongest of the series) and IF_5^+ could be clearly seen. No trace could be found again at $m/e = 356$ mass units.

Thus, from the recorded mass spectra no evidence could be found for the existence of the molecular dimer ion. Also under high vacuum conditions iodyl fluoride appears to partially decompose at temperatures well below the reported decomposition temperature.

The preparation of complexes of the iodyl ion, IO_2^+ , analogous to chloryl^{68,69} compounds have been attempted. Due to lack of handling facilities for either elemental fluorine or anhydrous hydrogen fluoride the number of possible preparations were reduced.

The preparation of iodyl fluorosulphate has been attempted. The most successful reagent for preparing complexes containing the fluorosulphate ion, SO_3F^- , is peroxydisulphuryl difluoride, $\text{S}_2\text{O}_6\text{F}_2$, several examples of the use of which have been reported^{41,42}. However, the preparation⁴⁰ of this compound involves the high temperature reaction between fluorine and sulphur trioxide. Thus, an alternative preparation to the reported one involving the reaction of iodine pentoxide and $\text{S}_2\text{O}_6\text{F}_2$ was employed. The preparation of $\text{IO}_2\text{SO}_3\text{F}$ has also been reported¹ in the reaction of iodyl fluoride and sulphur trioxide. This latter preparation was attempted but the analyses and vibrational spectra of the products were inconsistent with $\text{IO}_2\text{SO}_3\text{F}$. In addition certain experimental difficulties involving the removal of the solvent were experienced. An alternative preparation involving the reaction of iodyl fluoride and fluorosulphonic acid was then attempted. However, incorrect analysis results and inconsistent vibrational spectra were again obtained. Solvent removal also was difficult in this preparation. After the completion of these experiments the Raman spectrum of $\text{IO}_2\text{SO}_3\text{F}$ (prepared from I_2O_5 and $\text{S}_2\text{O}_6\text{F}_2$) was published by Carter and Aubke⁸. The conclusions they made from this spectrum have been discussed in Section I.

Complexes of iodyl fluoride with Lewis acids such as arsenic pentafluoride and boron trifluoride have been reported³⁵. However, these preparations involve the use of liquid hydrogen fluoride as a solvent. The infrared spectrum of $\text{IO}_2\text{F} \cdot \text{AsF}_5$ has been recorded by Carter and Aubke⁸. They concluded, however, that the simple ionic formation of $\text{IO}_2^+ \text{AsF}_6^-$ is not present in this compound. The preparation of a complex between iodyl fluoride and phosphorus pentafluoride at -80°C has been attempted. At this temperature PF_5 is a liquid and can thus act as both the solvent and a reactant.

However, from analysis results of the white product no reaction could be detected.

Aynsley has reported³⁸ the formation of the blue complex $\text{IO}_2\text{F}\cdot\text{O}\cdot 8\text{SbF}_5$ by the reaction of iodyl fluoride with excess antimony pentafluoride. This reaction has been repeated. Due to analytical difficulties, outlined in Section III detailed elemental analyses were not carried out for this compound. However, preliminary measurements do indicate an approximate composition of $\text{IO}_2\text{F}\cdot\text{O}\cdot 8\text{SbF}_5$. The Raman spectrum could not be recorded because of strong background scattering. The infrared spectrum of the dry powder between silver chloride plates is shown in figure II - A.10 together with that of iodyl fluoride and lithium hexafluoroantimonate¹⁹⁷, $\text{Li}^+\text{SbF}_6^-$.

From figure II - A.9. it can be seen that the infrared spectrum of $\text{IO}_2\text{F}\cdot\text{O}\cdot 8\text{SbF}_5$ is very different from that of the original iodyl fluoride. A strong absorption band can be seen in the region around 660 cm^{-1} , where the infrared active stretching fundamental of the SbF_6^- ion is known to occur. No band can be seen in the region $800 - 900\text{ cm}^{-1}$ where the stretching fundamentals of the IO_2^+ cation would be expected. Thus, this compound, as would be anticipated from other iodyl compounds, does not exist in a simple ionic formulation. The most probable structure would be similar to that suggested for $\text{IO}_2\text{F}\cdot\text{AsF}_5$ ⁸ i.e. an I - O - I bridging polymeric cation with SbF_6^- as the counter-ion. The vibrational frequencies of the cation are probably obscured by the strong absorption of the anion and should thus occur in the region $620 - 680\text{ cm}^{-1}$. The band at 470 cm^{-1} can thus be attributed to a deformation mode of the polymeric cation. However, without a satisfactory Raman spectrum and any explanation of the apparent non-stoichiometry of the compound the conclusions made from the infrared spectrum must be considered speculative.

FIGURE: II-A.10 COMPARISON OF THE INFRARED SPECTRA OF (i) THE COMPLEX BETWEEN IODYL
FLUORIDE AND ANTIMONY PENTAFLUORIDE AND (ii) IODYL FLUORIDE AND LITHIUM HEXAFLUOROANTIMONATE*

*(from; G.M.Begun and A.C.Rutenberg, reference 227)

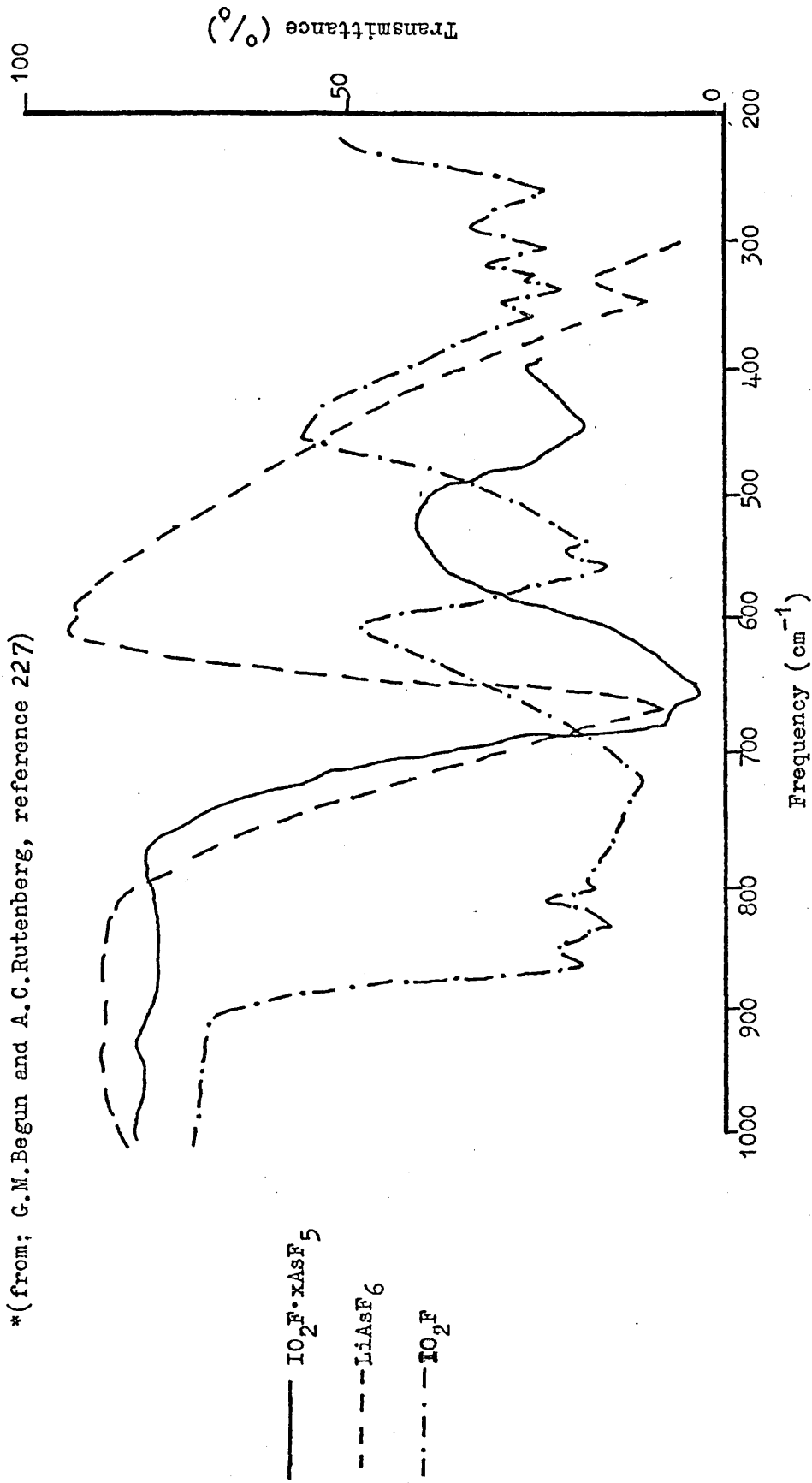

Hexafluoroiodate Compounds, MIF_6 ($M = K, Rb, Cs$)

The infrared spectra of KIF_6 , $RbIF_6$ and $CsIF_6$ are recorded in table II - A.7. The solid-stated spectra were recorded as nujol mulls which were then exposed to moist air for a period of time. The spectra were again recorded in order to identify the small amount of hydrolysis product present in each spectrum. Table II - A.9 contains the infrared spectra obtained by Christe for the 1 : 1 and 1 : 3 adducts of metal fluorides and iodine pentafluoride, $RbF \cdot 1.7IF_5$ being a mixture of the 1 : 1 and 1 : 3.

It can be seen from tables II - A.7. and II - A.8. that the recorded spectra of this investigation all agree with Christe's for the 1 : 1 adduct. The 1 : 3 spectra contain strong absorption bands in the region of 680 cm^{-1} . No trace could be seen in any of the spectra of these strong bands. It can thus be concluded that, as indicated from the analysis results, only 1 : 1 adducts of metal fluorides and iodine pentafluoride are present. The existence of only the 1 : 1 adducts may be due to using a different preparation from Christe i.e. using the iodides and not the fluorides as the starting materials. It could also be due to the heating under vacuum that takes place to remove any remaining iodine.

Table II - A.7.

Infrared Spectrum of Hexafluoriodates

KIF_6 (cm^{-1})	RbIF_6 (cm^{-1})	CsIF_6 (cm^{-1})
620(w.sh)		
600(m)	600(m)	599(m)
570-470(v.s,br)	560-480(v.s,br)	560-480(v.s,br)
389(m)	385(m)	386(m)
335(m)	330(m)	330(m)
272(m)	262(m)	265(m)
210(w.sh)	210(w.sh)	210(w.sh)
185(m)	185(m)	190(m)

Table II - A.8.

Infrared Spectra of KIF_6 , RbIF_6 , CsIF_6 , $\text{CsF} \cdot 3\text{IF}_5$ and $\text{RbF} \cdot 1.7\text{IF}_5$ *

*(from reference 134 : K.O. Christie Inorg.Chem. II, 1215 (1972))

KIF_6	RbIF_6	CsIF_6	$\text{CsF} \cdot 3\text{IF}_5$	$\text{RbF} \cdot 1.7\text{IF}_5$
			677(s)	677(s)
			635(sh)	
625(sh)	620(sh)	620(sh)		
609(s)	599(sh)	599(s)		610(v.s)
			584	584(m.s)
			569	
			552	550(s)
570-500(v.s,br)	570-500(v.s,br)	570-500(v.s,br)	545(sh)	
393(m.s)	391(m.s)	390(m.s)		391(s)
			385(m)	
			369(m)	370(m.w)
341(m.s)	337(m.s)	335(m.s)		335(sh)
			320(s)	318(s)
290(w)	288(sh)			285(sh)
268(m.s)	260(m.s)	260(m.s)	271(m)	260(s)

II - B Thermodynamic Properties

The enthalpies of formation derived in this section were obtained from the experimentally determined enthalpies of reaction, using ancillary data. All values are quoted at 298.15°K. The dilution factor, n, refers to the mole ratio of water to reactant. Heats of mixing and ampoule breaking have been considered negligible (see Section III).

The error limits of the experimental and derived results and ancillary data are discussed in Appendix II.

Dioxodifluoroiodate Salts, MIO_2F_2

The enthalpy changes associated with the reaction of dioxodifluoroiodate salts and dilute sodium hydroxide (0.100M) have been measured. The reaction of the powdered crystals and dilute alkali was smooth and complete in about one minute, as indicated from the reaction time-resistance trace.

Sodium Dioxodifluoroiodate, NaIO_2F_2

The heat of reaction data for the reaction:

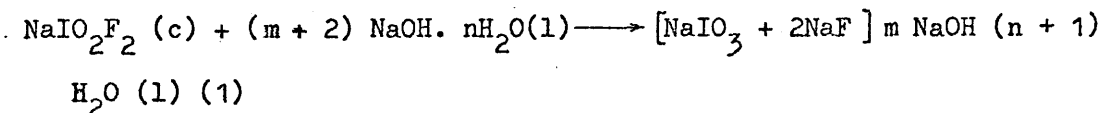

are recorded in table II - B.1.

Mean value of $\Delta H_R = -25.31 \pm 0.22 \text{ K.cal.mol}^{-1} (-105.9 \pm 0.9 \text{ K.J.mol}^{-1})$

From equation (1): $\Delta H_f^\circ \text{NaIO}_2\text{F}_2(\text{c}) = \Delta H_f^\circ \text{NaIO}_3 (5000 \text{ H}_2\text{O}) + 2 \Delta H_f^\circ \text{NaF} (3000 \text{ H}_2\text{O}) + \Delta H_f^\circ \text{H}_2\text{O} - 2 \Delta H_f^\circ \text{NaOH} (500 \text{ H}_2\text{O}) - \Delta H_R$

Using the ancillary data contained in table II - B.5.

$$\underline{\underline{\text{NaIO}_2\text{F}_2 (\text{c}) = -202.85 \pm 0.3 \text{ K. cal.mol}^{-1} (-848.7 \pm 1.2 \text{ K.J.mol}^{-1})}}$$

Potassium Dioxodifluoroiodate, KIO_2F_2

The heat of reaction data for the reaction:

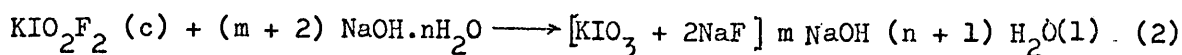

are recorded in table II - B.2.

$$\text{Mean value of } \Delta H_R = -21.34 \pm 0.34 \text{ K cal mol}^{-1} \quad (-89.3 \pm 1.4 \text{ K.J. mol}^{-1})$$

From equation (2):

$$\begin{aligned} \Delta H_f^\circ \text{KIO}_2\text{F}_2 (c) &= \Delta H_f^\circ \text{KIO}_3(5000 \text{H}_2\text{O}) + 2 \Delta H_f^\circ \text{NaF} (3000 \text{H}_2\text{O}) \\ &+ \Delta H_f^\circ \text{H}_2\text{O} - 2 \Delta H_f^\circ \text{NaOH} (500 \text{H}_2\text{O}) - \Delta H_R \end{aligned}$$

Using ancillary data contained in table II - B.5.

$$\underline{\Delta H_f^\circ \text{KIO}_2\text{F}_2 (c) = -209.5 \pm 0.4 \text{ K.cal mol}^{-1} \quad (-876.6 \pm 1.6 \text{ K.J. mol}^{-1})}$$

Rubidium Dioxodifluoroiodate, RbIO_2F_2

The heat of reaction data for the reaction:

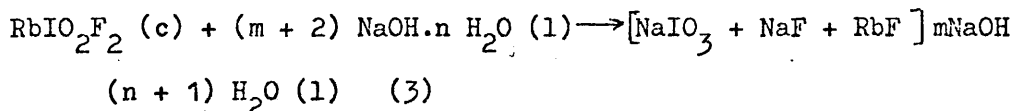

are contained in table II - B.3.

$$\begin{aligned} \text{The mean value of } \Delta H_R &= -20.72 \pm 0.12 \text{ K.cal mol}^{-1} \\ &(-86.7 \pm 0.5 \text{ K.J. mol}^{-1}) \end{aligned}$$

From equation 3:

$$\begin{aligned} \Delta H_f^\circ \text{RbIO}_2\text{F}_2 (c) &= \Delta H_f^\circ \text{NaIO}_2\text{F}_2 (5000 \text{H}_2\text{O}) + \Delta H_f^\circ \text{NaF} (5000 \text{H}_2\text{O}) \\ &+ \Delta H_f^\circ \text{RbF} (5000 \text{H}_2\text{O}) + \Delta H_f^\circ \text{H}_2\text{O} - 2 \Delta H_f^\circ \text{NaOH} (500 \text{H}_2\text{O}) - \Delta H_R \end{aligned}$$

Using ancillary data contained in table II - B.5.

$$\underline{\Delta H_f^\circ \text{RbIO}_2\text{F}_2 (c) = -209.2 \pm 0.3 \text{ K.cal.mol}^{-1} \quad (-875.3 \pm 1.2 \text{ K.J.mol}^{-1})}$$

Ammonium Dioxodifluoriodate, $\text{NH}_4\text{IO}_2\text{F}_2$

The heat of reaction data for the reaction:

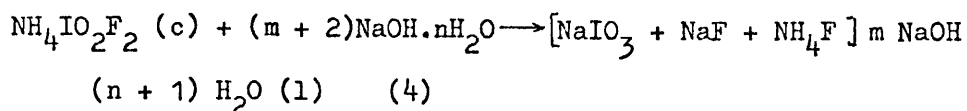

are recorded in table II B.4.

$$\text{The mean value of } \Delta H_{\text{R}} = -24.75 \pm 0.16 \text{ K.cal.mol}^{-1} \\ (-103.56 \pm 0.66 \text{ K.J. mol}^{-1})$$

From equation 4:

$$\Delta H_{\text{f}}^{\circ} \text{NH}_4\text{IO}_2\text{F}_2 (\text{c}) = \Delta H_{\text{f}}^{\circ} \text{NaIO}_3 (5000 \text{ H}_2\text{O}) + \Delta H_{\text{f}}^{\circ} \text{NaF} (5000 \text{ H}_2\text{O}) \\ + \Delta H_{\text{f}}^{\circ} \text{NH}_4\text{F} (5000 \text{ H}_2\text{O}) + \Delta H_{\text{f}}^{\circ} \text{H}_2\text{O} - 2\Delta H_{\text{f}}^{\circ} \text{NaOH} (500 \text{ H}_2\text{O}) - \Delta H_{\text{R}}$$

Using ancillary data contained in table II - B.5.

$$\underline{\Delta H_{\text{f}}^{\circ} \text{NH}_4\text{IO}_2\text{F}_2 (\text{c}) = 178.8 \pm 0.3 \text{ K.cal.mol}^{-1} \quad (-747.6 \pm 1.2 \text{ K.J.mol}^{-1})}$$

Caesium Dioxodifluoriodate, CsIO_2F_2

The enthalpy of formation of caesium dioxodifluoriodate, which has not been prepared (Section III), can be approximately estimated from the trends exhibited by the differences in the enthalpies of formation of alkali metal salts with changing cation.

These trends are shown in figure II - B.1, from which

$$\Delta H_{\text{f}}^{\circ} \text{CsIO}_2\text{F}_2 (\text{c}) = 210 \text{ K.cal.mol}^{-1} \text{ was deduced.}$$

FIGURE: II-B.1 DIFFERENCES IN THE ENTHALPIES OF FORMATION OF ALKALI METAL SALTS*

*(from reference 198)

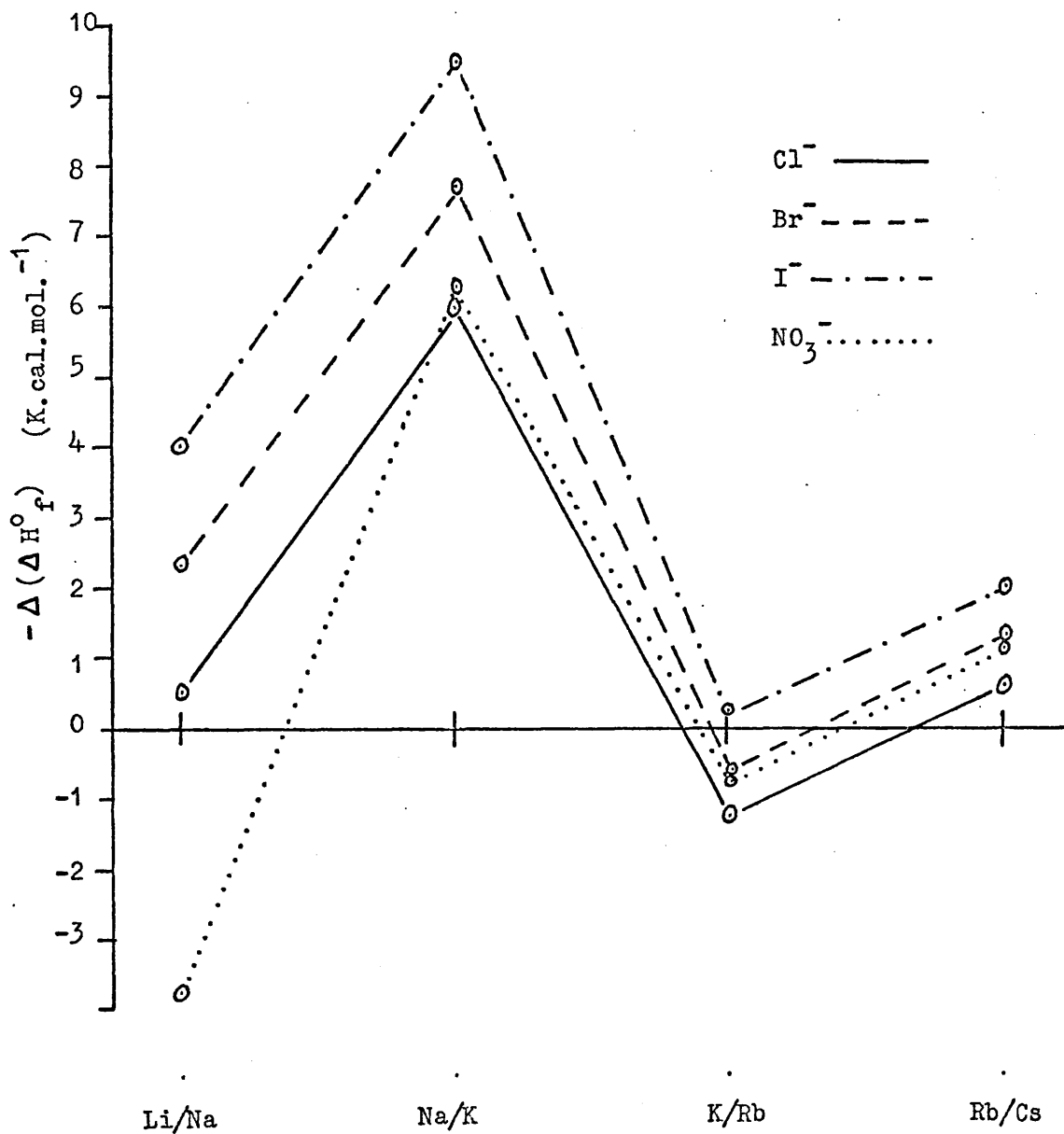

Table II - B.1.

Enthalpy of Reaction of Sodium Dioxodifluoroiodate
with aqueous Sodium Hydroxide (0.100M)

	$\frac{m(\text{NaIO}_2\text{F}_2)}{g}$	dilution, n	$-\Delta H_R$	
			K. cal. mol ⁻¹	K.J. mol ⁻¹
1	0.6975	3503	25.38	106.19
2	0.7676	3183	25.86	108.20
3	0.6762	3613	25.98	108.70
4	0.6042	4044	25.26	105.69
5	0.3806	6419	25.23	105.62
6	0.5423	4505	25.19	105.39
7	0.8802	2776	25.46	106.52
8	0.9015	2710	24.97	104.47
9	0.5190	4708	25.30	105.86
10	0.7196	3395	24.86	104.01
11	0.4873	5014	24.95	104.39

Table II - B.2.

Enthalpy of Reaction of Potassium Dioxofluoroiodate

with aqueous Sodium Hydroxide (0.100M)

	m(KIO ₂ F ₂) g	dilution, n	- ΔH _R	
			K.cal.mol ⁻¹	K.J.mol ⁻¹
1	0.3334	7865	21.95	91.84
2	0.5178	5064	21.16	88.53
3	0.3653	7178	22.54	94.31
4	0.5521	4750	21.70	90.79
5	0.5589	4692	20.56	86.02
6	0.5393	4862	21.77	91.09
7	0.6956	3769	20.43	85.42
8	0.5985	4381	21.24	88.87
9	0.6400	4097	21.31	89.16
10	0.5490	4776	21.33	89.24
11	0.7270	3607	21.24	88.87
12	0.7267	3608	20.87	87.32

Table II - B.3.

Enthalpy of Reaction of Rubidium Dioxodifluoroiodate
with aqueous Sodium Hydroxide (0.100M)

	m(RbIO ₂ F ₂) g	dilution, n	- ΔH _R	
			K.cal.mol ⁻¹	K.J.mol ⁻¹
1	0.7756	4181	20.60	86.19
2	0.7736	4192	20.70	86.60
3	0.6864	4724	20.80	87.03
4	0.6961	4658	20.74	86.78
5	0.5204	6231	21.18	88.62
6	0.5379	6028	20.77	86.90
7	0.7693	4215	20.42	85.43
8	0.7390	4388	20.55	85.98
9	0.6263	5177	20.74	86.78
10	0.8083	4012	20.66	86.44

Table II - B.4.

Enthalpy of Reaction of Ammonium Dioxofluoriodate
with aqueous Sodium Hydroxide (0.100M)

	m(NH ₄ IO ₂ F ₂) g	dilution, n	- ΔH _R	
			K.cal.mol ⁻¹	K.J.mol ⁻¹
1	0.3903	6119	24.97	104.47
2	0.3682	6487	24.63	103.05
3	0.5253	4547	24.62	103.01
4	0.4932	4843	24.44	102.26
5	0.3378	7070	24.81	103.81
6	0.4767	5010	24.83	103.89
7	0.3440	6943	24.97	104.47

Table II - B.5.

Ancillary Data

Compound	$-\Delta H_f^\circ$ (K.cal.mol ⁻¹)	Reference
H ₂ O	68.315 ± 0.01	197
NaIO ₃ (5000 H ₂ O)	112.28 ± 0.1	198
NaF (5000 H ₂ O)	135.90 ± 0.1	198
NaF (3000 H ₂ O)	135.88 ± 0.1	198
NaOH (500 H ₂ O)	112.117 ± 0.01	198
KIO ₃ (5000 H ₂ O)	114.98 ± 0.1	198
RbF (5000 H ₂ O)	137.57 ± 0.1	198
NH ₄ F (5000 H ₂ O)	111.26 ± 0.1	199

The large negative values of the enthalpies of formation of dioxodifluoroiodate salts indicate thermodynamic stability, which is consistent with the storage behaviour over long periods at room temperature.

The lattice energies of the IO_2F_2^- salts have been calculated using the modified Kapustinskii equation discussed in Appendix I. From a knowledge of the lattice energies the enthalpies of formation of hypothetical salts can be found.

$$U_0 = \frac{287.2 V Z_+ Z_-}{r_c + r_a} \left[1 - \frac{0.345}{r_c + r_a} \right] + 2.5 V Z_+ Z_- \quad (5)$$

where V = number of ions per molecule, Z_+ and Z_- are the cationic and anionic charges and r_c and r_a are the cationic and anionic radii. Thus for a uni-univalent salt equation (5) becomes:

$$U_0 = \frac{574.4}{r_c + r_a} \left[1 - \frac{0.345}{r_c + r_a} \right] + 5.0 \text{ K. cal. mol}^{-1} \quad (6)$$

Thus, only a knowledge of r_c and r_a is needed to calculate lattice energies.

When considering IO_2F_2^- salts the ionic radii of the alkali metal cations are known. Therefore, a 'thermochemical' radius may be ascribed to the complex anion by the method of Yatsimirskii described in Appendix I. Consider two salts $\text{M}_1\text{IO}_2\text{F}_2$ and $\text{M}_2\text{IO}_2\text{F}_2$.

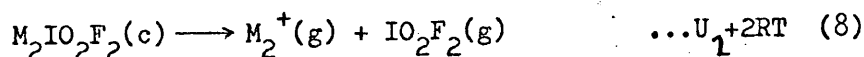
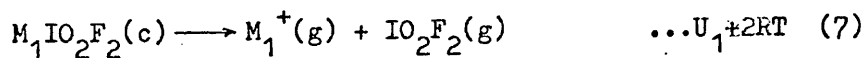

$$(7) - (8) \quad U_1 - U_2 = \Delta H_f^\circ \text{M}_1^+(\text{g}) - \Delta H_f^\circ \text{M}_2^+(\text{g}) - \Delta H_f^\circ \text{M}_1\text{IO}_2\text{F}_2(\text{c}) + \Delta H_f^\circ \text{M}_2\text{IO}_2\text{F}_2(\text{c}) \quad (9)$$

$$\text{From eqn. (6) } U_1 - U_2 = C \left[\frac{1}{(r_{\text{M}_1^+} + r_{\text{IO}_2\text{F}_2^-})} \left(1 - \frac{0.345}{(r_{\text{M}_1^+} + r_{\text{IO}_2\text{F}_2^-})} \right) - \frac{1}{(r_{\text{M}_2^+} + r_{\text{IO}_2\text{F}_2^-})} \left(1 - \frac{0.345}{(r_{\text{M}_2^+} + r_{\text{IO}_2\text{F}_2^-})} \right) \right] \quad (10)$$

To solve for $r_{\text{IO}_2\text{F}_2^-}$ eqn. (10) reduces to:

$$0 = r^4 + 2r^3(m_1 + m_2) + r^2 [m_1^2 + m_2^2 + 4m_1m_2 + c(m_1 - m_2)] \\ + r [2m_1^2m_2 + 2m_1m_2^2 + c(m_1^2 - m_2^2) - 0.69c(m_1 - m_2)] \\ + [m_1^2m_2^2 + c(m_1^2m_2 - m_2^2m_1) + 0.345c (m_2^2 - m_1^2)] \quad (11)$$

where m_1 and $m_2 = r_{M_1^+}$ and $r_{M_2^+}$ = ionic radii of cations,

$r = r_{\text{IO}_2\text{F}_2^-}$ = 'thermochemical' radius of the anion, and $C = \frac{574.4}{U_1 - U_2}$

Thus, by calculating $U_1 - U_2$ from equation (9) the 'thermochemical' radius of the IO_2F_2^- ion can be found from equation (11). This procedure has been carried out using the salts NaIO_2F_2 , KIO_2F_2 and RbIO_2F_2 . The ammonium salt was not included as the value of $\Delta H_f^\circ (\text{NH}_4^+, \text{g})$ is only known approximately; a recent electron impact study²⁰⁰ cites a value of Ca 148 K.cal.mol⁻¹. The relevant data needed for the calculations have been obtained from Johnson²⁰¹ and are contained in table II - B.6.

Table II - B.6.

	ΔH_f° K.cal.mol ⁻¹		ionic radius o A
(Na ⁺ , g)	145.9	Na ⁺	1.00
(K ⁺ , g)	123.0	K ⁺	1.33
(Rb ⁺ , g)	117.4	Rb ⁺	1.47

From equations (9) and (11) the following values of the 'thermochemical' radius of the IO_2F_2^- ion have been calculated:

$$\text{K}^+/\text{Na}^+ = 1.82\text{\AA}$$

$$\text{Na}^+/\text{Rb}^+ = 1.85\text{\AA}$$

$$\text{K}^+/\text{Rb}^+ = 1.88\text{\AA}$$

$$\text{Mean value} = 1.85 \pm 0.03\text{\AA}$$

Substituting this radius into equation (6) the following lattice energies have been calculated:

$$\underline{\underline{U_o (\text{NaIO}_2\text{F}_2, \text{c}) = 182 \text{ K.cal.mol}^{-1} (762 \text{ K.J.mol}^{-1})}}$$

$$\underline{\underline{U_o (\text{KIO}_2\text{F}_2, \text{c}) = 166 \text{ K.cal.mol}^{-1} (695 \text{ K.J.mol}^{-1})}}$$

$$\underline{\underline{U_o (\text{RbIO}_2\text{F}_2, \text{c}) = 160 \text{ K.cal.mol}^{-1} (669 \text{ K.J.mol}^{-1})}}$$

It is difficult to assign error limits to the above values but it is probably right to conclude they are correct to within 10 K.cal mol⁻¹. A difference of $\pm 0.1\text{\AA}$ in the 'thermochemical' radius generates an uncertainty of $\pm 5/6$ K. cal.mol⁻¹ in lattice energies values.

The enthalpy of formation of the gaseous IO_2F_2^- ion can now be calculated.

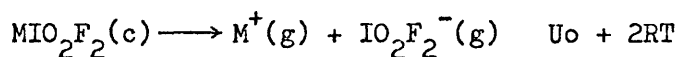

$$\Delta H_f^\circ(\text{IO}_2\text{F}_2, \text{g}) = U_o + 2RT - \Delta H_f^\circ\text{M}^+(\text{g}) + \Delta H_f^\circ\text{MIO}_2\text{F}_2(\text{c}) \quad (12)$$

From (12):

Table II - B.7.

calculated from	$-\Delta H_f^\circ(\text{IO}_2\text{F}_2^-, \text{g})$	
	K.cal.g.ion ⁻¹	K.J.g.ion ⁻¹
KIO_2F_2	165.3	691.5
NaIO_2F_2	165.5	692.5
RbIO_2F_2	165.4	692

$$\text{Thus, } \underline{\Delta H_f^\circ (\text{IO}_2\text{F}_2^-, \text{g})} = \underline{-165.5 \text{ K.cal.g.ion}} \quad (\underline{692 \text{ K.J.g.ion}^{-1}})$$

From the knowledge of the 'thermochemical' radius of the IO_2F_2^- ion and $\Delta H_f^\circ (\text{IO}_2\text{F}_2^-, \text{g})$ the lattice energy and enthalpy of formation of any salt containing the IO_2F_2^- ion can now be calculated from equations (6) and (12). The results of these calculations are shown in table II - B.8, together with all ancillary data used. The ancillary data have been taken from Johnson,²⁰¹ except $\Delta H_f^\circ (\text{NH}_4^+, \text{g})$ ²⁰⁰.

Table II - B.8.

Lattice Energies and Enthalpies of Formation
of other Dioxodifluoroiodate Compounds

Compound	ionic radius $M^{n+}(\text{\AA})$	$\Delta H_f^\circ (M^{n+}, \text{g})$ (K.cal.g.ion ⁻¹)	$U_c(M(\text{IO}_2\text{F}_2)_n, \text{c})$		$-\Delta H_f^\circ (M(\text{IO}_2\text{F}_2)_n, \text{c})$	
			K.cal.mol ⁻¹	K.J.mol ⁻¹	K.cal.mol ⁻¹	K.J.mol ⁻¹
$\text{NH}_4\text{IO}_2\text{F}_2$	1.44	148	161	675	180	753
CsIO_2F_2	1.68	109.9	152	635	209	872
LiIO_2F_2	0.68	164.3	201	841	203	851
$\text{Mg}(\text{IO}_2\text{F}_2)_2$	0.68	561.3	593	2482	364	1523
$\text{Ca}(\text{IO}_2\text{F}_2)_2$	0.99	459.8	538	2251	410	1715
$\text{Sr}(\text{IO}_2\text{F}_2)_2$	1.16	427.7	512	2141	416	1741
$\text{Ba}(\text{IO}_2\text{F}_2)_2$	1.34	396.2	487	2037	423	1768
AgIO_2F_2	1.13	244.2	175	734	98	409

It can be seen from table II - B.8. that the values calculated for $\Delta H_f^\circ (\text{NH}_4\text{IO}_2\text{F}_2, \text{c})$ and $\Delta H_f^\circ (\text{CsIO}_2\text{F}_2, \text{c})$ agree well with the measured and estimated values respectively i.e. $\Delta H_f^\circ (\text{NH}_4\text{IO}_2\text{F}_2, \text{c})$: $-178.7 \text{ K.cal.mol}^{-1}$,

(estimated from figure II -.B.1.) and $-209 \text{ K.cal.mol}^{-1}$ (calculated).

The alkaline earth salts appear to be stable compounds but their preparation will be probably determined by the solubility of the iodates in aqueous on anhydrous hydrogen fluoride. The preparation of AgIO_2F_2 has been reported previously.

Hexafluoroiodate Compounds, MIF_6

The enthalpies of reaction of alkali metal hexafluoroiodates and dilute sodium hydroxide (0.100M) were measured. The reactions were fast ($t < 1$ minute) but not violent.

Potassium Hexafluoroiodate, KIF_6

The enthalpy of reaction data for the reaction:

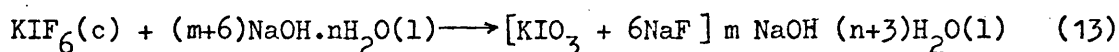

are contained in table II - B.9.

$$\text{Mean } \Delta H_{\text{R}} = \underline{-106.10 \pm 0.52 \text{ K.cal.mol}^{-1}} \quad (\underline{443.9 \pm 2.2 \text{ K.J.mol}^{-1}})$$

From equation (13)

$$\begin{aligned} \Delta H_{\text{f}}^{\circ} \text{KIF}_6(\text{c}) &= \Delta H_{\text{f}}^{\circ} \text{KIO}_3(20000 \text{ H}_2\text{O}) + 6 \Delta H_{\text{f}}^{\circ} (3000 \text{ H}_2\text{O}) + 3 \Delta H_{\text{f}}^{\circ} \text{H}_2\text{O} \\ &\quad - 6 \Delta H_{\text{f}}^{\circ} \text{NaOH} (500 \text{ H}_2\text{O}) - \Delta H_{\text{R}}. \end{aligned}$$

Using ancillary data contained in II - B.12.

$$\underline{\Delta H_{\text{f}}^{\circ} \text{KIF}_6(\text{c})} = \underline{-356.4 \pm 0.6 \text{ K.cal.mol}^{-1}} \quad (\underline{1491 \pm 2.5 \text{ K.J.mol}^{-1}})$$

Rubidium Hexafluoroiodate, RbIF_6

The enthalpy of reaction data for the reaction:

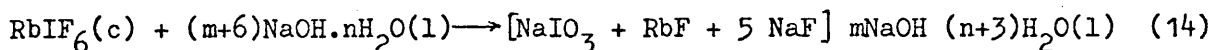

are contained in table II - B.10.

$$\text{Mean } \Delta H_{\text{R}} = \underline{-109.53 \pm 0.40 \text{ K.cal.mol}^{-1}} \quad (\underline{458.3 \pm 1.7 \text{ K.J.mol}^{-1}})$$

From equation (14)

$$\begin{aligned} \Delta H_{\text{f}}^{\circ} \text{RbIF}_6(\text{c}) &= \Delta H_{\text{f}}^{\circ} \text{NaIO}_3(20000 \text{ H}_2\text{O}) + 5 \Delta H_{\text{f}}^{\circ} \text{NaF}(4000 \text{ H}_2\text{O}) + 3 \Delta H_{\text{f}}^{\circ} \text{H}_2\text{O} \\ &\quad + \Delta H_{\text{f}}^{\circ} \text{RbF} (20000 \text{ H}_2\text{O}) - 6 \Delta H_{\text{f}}^{\circ} \text{NaOH} (500 \text{ H}_2\text{O}) - \Delta H_{\text{R}} \end{aligned}$$

Using ancillary data contained in table II - B.12.

$$\underline{\Delta H_f^\circ \text{RbIF}_6(\text{c}) = -352.1 \pm 0.5 \text{ K.cal.mol}^{-1} \quad (1473 \pm 2 \text{ K.J.mol}^{-1})}$$

Caesium Hexafluoroiodate, CsIF₆

The enthalpy of reaction data for the reaction:

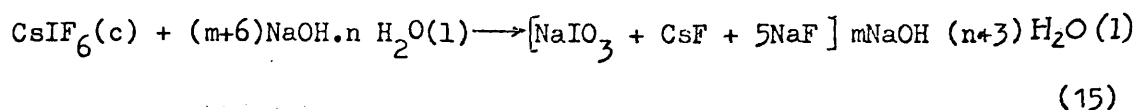

are contained in table II - B.11.

$$\text{Mean } \Delta H_R = -109.48 \pm 0.40 \text{ K.cal.mol}^{-1} \quad (458.1 \pm 1.7 \text{ K.J.mol}^{-1})$$

From equation (15)

$$\Delta H_f^\circ \text{CsIF}_6(\text{c}) = \Delta H_f^\circ \text{NaIO}_3(20000 \text{ H}_2\text{O}) + \Delta H_f^\circ \text{CsF}(20000 \text{ H}_2\text{O}) + \\ 5 \Delta H_f^\circ \text{NaF}(4000 \text{ H}_2\text{O}) + 3 \Delta H_f^\circ \text{H}_2\text{O} - 6 \Delta H_f^\circ \text{NaOH}(500 \text{ H}_2\text{O}) - \Delta H_R$$

Using ancillary data contained in table II - B.12.

$$\underline{\Delta H_f^\circ \text{CsIF}_6(\text{c}) = -350.4 \pm 0.5 \text{ K.cal.mol}^{-1} \quad (1466 \pm 2 \text{ K.J.mol}^{-1})}$$

Table II - B.9.

Enthalpy of Reaction of Potassium Hexafluoroiodate
and aqueous Sodium Hydroxide (0.100M)

	$m(\text{KIF}_6)$ g	dilution, n	$-\Delta H_R$	
			K.cal.mol ⁻¹	K.J.mol ⁻¹
1	0.1912	16272	106.57	445.9
2	0.1560	19943	106.52	445.7
3	0.1751	17768	105.16	440.0
4	0.1085	28674	107.39	449.3
5	0.1835	16954	106.00	443.5
6	0.1683	18486	105.42	441.1
7	0.1285	24211	106.33	444.9
8	0.1405	22143	104.75	438.3
9	0.1849	16826	105.71	442.3
10	0.1593	19530	107.16	448.4

Table II - B.10

Enthalpy of Reaction of Rubidium Hexafluoroiodate
and aqueous Sodium Hydroxide (0.100M)

	m(RbIO ₂ F ₂) g	dilution, n	- ΔH _R	
			K.cal.mol ⁻¹	K.J.mol ⁻¹
1	0.1559	23261	108.77	455.1
2	0.1460	24838	109.98	460.2
3	0.1570	23098	109.12	456.6
4	0.1888	19207	109.94	460.0
5	0.1865	19444	109.91	459.9
6	0.1843	19676	109.47	458.0
7	0.1511	23999	108.26	453.0
8	0.1826	19859	110.01	460.3
9	0.1855	19549	109.01	456.1
10	0.1444	25113	109.93	460.0
11	0.1473	24619	110.43	462.0

Table II - B.11

Enthalpy of Reaction of Caesium Hexafluoroiodate
and aqueous Sodium Hydroxide (0.100M)

	m(CsIO_2F_2) g	dilution, n	$-\Delta H_R$	
			K.cal.mol ⁻¹	K.J.mol ⁻¹
1	0.1610	25797	109.98	460.2
2	0.2551	16281	109.24	457.1
3	0.1859	22342	109.51	458.2
4	0.2185	19008	109.27	457.2
5	0.2227	18649	109.01	456.1
6	0.1801	23061	109.29	457.3
7	0.2056	20201	109.12	456.6
8	0.1854	22402	110.26	461.3
9	0.1702	24403	110.68	463.1

Table II - B.12

Ancillary Data

Compound	$-\Delta H_f^\circ$ (K.cal.mol ⁻¹)	Reference
H ₂ O	68.315 ± 0.01	197
KIO ₃ (20,000 H ₂ O)	115.00 ± 0.1	198
NaF (3,000 H ₂ O)	135.88 ± 0.1	198
NaF (4,000 H ₂ O)	135.90 ± 0.1	198
RbF (20,000 H ₂ O)	137.58 ± 0.1	198
CsF (20,000 H ₂ O)	135.88 ± 0.1	198
NaOH (500 H ₂ O)	112.117 ± 0.01	198
NaIO ₃ (20,000 H ₂ O)	112.28 ± 0.1	198

Assuming totally ionicity, the lattice energies of hexafluoroiodate compounds have been calculated using the identical procedure to that of the dioxodifluoroiodate salts.

Substituting values of $\Delta H_f^\circ (M^+, g)$ contained in tables II - B.6. and II - B.8. into equations (9) and (11), the following values of the 'thermochemical' radius of the IF_6^- ion have been calculated:

$$K^+/Rb^+ = 1.00\text{\AA}$$

$$K^+/Cs^+ = 1.33\text{\AA}$$

$$Cs^+/Rb^+ = 1.66\text{\AA}$$

$$\text{Mean value} = 1.33 \pm 0.33\text{\AA}$$

Substituting this radius into equation (6) the following lattice energies have been calculated:

$$\underline{U_o (KIF_6, c) = 193 \text{ K.cal.mol}^{-1} \quad (807 \text{ K.J.mol}^{-1})}$$

$$\underline{U_o (RbIF_6, c) = 185 \text{ K.cal.mol}^{-1} \quad (774 \text{ K.J.mol}^{-1})}$$

$$\underline{U_o (CsIF_6, c) = 174 \text{ K.cal.mol}^{-1} \quad (728 \text{ K.J.mol}^{-1})}$$

Due to the less consistent values obtained for the 'thermochemical' radius of the IF_6^- ion in comparison with the $IO_2F_2^-$ ion larger error limits must be assigned to the above lattice energies. A value of $\pm 20 \text{ K.cal.mol}^{-1}$ is probably realistic (a change of $\pm 0.1\text{\AA}$ in the 'thermochemical' radius generates a $\pm 6 - 7 \text{ K.cal.mol}^{-1}$ change in the lattice energies).

The enthalpy of formation of the gaseous IF_6^- ion can now be calculated.

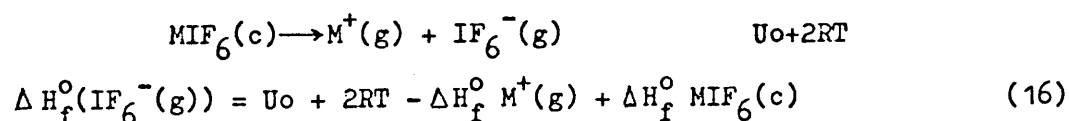

From (16)

Table II - B.13

calculated from	$- H_f^{\circ}(\text{IF}_6^-, \text{g})$	
	K.cal.mol ⁻¹	K.J.mol ⁻¹
KIF ₆	285.2	1193
RbIF ₆	283.3	1185
CsIF ₆	285.1	1193

Thus, $\Delta H_f^{\circ}(\text{IF}_6^-, \text{g}) = -284.5 \text{ K.cal.mol}^{-1} \quad (-1190 \text{ K.J.mol}^{-1})$

Using equations (6) and (12) the lattice energy and enthalpy of formation of a salt containing the IF_6^- ion can now be calculated, as shown in table II - B.14. All ancillary data have been recorded previously in tables II - B.6. and II - B.8.

Table II - B.14

Lattice Energies and Enthalpies of Formation of Hexafluoroiodate Compounds

Compound	$U_0[M(IF_6)_n, c]$		$-\Delta H_f^0[M(IF_6)_n, c]$	
	K.cal.mol ⁻¹	K.J.mol ⁻¹	K.cal.mol ⁻¹	K.J.mol ⁻¹
LiIF ₆	242	1013	363	1519
NaIF ₆	215	900	355	1485
NH ₄ IF ₆	187	782	325	1360
Mg(IF ₆) ₂	715	2992	724	3029
Ca(IF ₆) ₂	637	2665	747	3125
Sr(IF ₆) ₂	601	2515	744	3113
Ba(IF ₆) ₂	567	2372	741	3100
AgIF ₆	206	862	248	1038

The lattice energies and the enthalpies of formation calculated from them for the dioxodifluoroiodate and hexafluoroiodate compounds can only be considered to be approximate because of the assumption made in the Kapustinskii equation (**Appendix I**). In spite of these deficiencies, however, the Kapustinskii equation has provided a useful guide to the lattice energies of compounds where insufficient structural data exclude the possibility of more precise answers by extended calculations.

Iodine Oxide Trifluoride, IOF₃

The enthalpy change associated with the reaction of iodine oxide trifluoride and dilute sodium hydroxide (1.000M) has been measured. The reaction of the needle crystals and dilute alkali

was rapid ($t < 1$ minute). A slight acid mist formed above the liquid but quickly dissolved with no apparent effect upon the reaction trace.

The enthalpy of reaction data for the reaction:

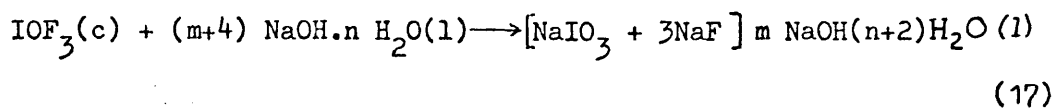

are contained in table II - B.15.

$$\text{Mean } \Delta H_{\text{R}} = -75.44 \pm 0.50 \text{ K.cal.mol}^{-1} \quad (-315.64 \pm 2.09 \text{ K.J.mol}^{-1})$$

From equation (17):

$$\begin{aligned} \Delta H_{\text{f}}^{\circ} \text{IOF}_3(\text{c}) &= \Delta H_{\text{f}}^{\circ} \text{NaIO}_3(15000 \text{ H}_2\text{O}) + 3 \Delta H_{\text{f}}^{\circ} \text{NaF}(5000 \text{ H}_2\text{O}) \\ &+ 2 \Delta H_{\text{f}}^{\circ} \text{H}_2\text{O} - 4 \Delta H_{\text{f}}^{\circ} \text{NaOH}(50 \text{ H}_2\text{O}) - \Delta H_{\text{R}} \end{aligned}$$

Using ancillary data contained in table II-B.16.

$$\underline{\Delta H_{\text{f}}^{\circ} \text{IOF}_3(\text{c}) = -132.7 \pm 0.6 \text{ K.cal.mol}^{-1} \quad (-555.2 \pm 2.5 \text{ K.J.mol}^{-1})}$$

Table II - B.15

Enthalpy of Reaction of Iodine Oxide Trifluoride
and aqueous Sodium Hydroxide (1.000M)

	m(IOF ₃) g	dilution, n	- ΔH _R	
			K.cal.mol ⁻¹	K.J.mol ⁻¹
1	0.1240	17,912	75.61	316.4
2	0.1106	20,082	77.21	323.1
3	0.2109	10,513	75.10	314.2
4	0.1796	12,367	75.77	317.0
5	0.1769	12,556	74.63	312.2
6	0.1700	13,065	75.20	314.6
7	0.2006	11,072	75.67	316.6
8	0.1380	16,095	75.64	316.48
9	0.1944	11,425	74.81	313.01
10	0.2297	9,670	74.74	312.71

Table II - B.16

Ancillary Data

Compound	$-\Delta H_f^\circ (\text{K.cal.mol}^{-1})$	Reference
H ₂ O	68.315 ± 0.01	197
NaOH(50 H ₂ O)	112.154 ± 0.01	198
NaIO ₃ (15,000 H ₂ O)	112.28 ± 0.1	198
NaF(5,000 H ₂ O)	135.90 ± 0.1	198

Iodyl Fluoride, IO₂F

The enthalpy change associated with the reaction of iodyl fluoride and dilute sodium hydroxide (0.100M) has been measured. The reaction was smooth rapid (t < 1 minute). The enthalpy of reaction data for the reaction:

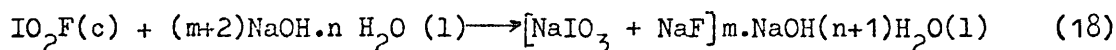

are contained in table II - B.17.

$$\text{Mean } \Delta H_R = -33.34 \pm 0.24 \text{ K.cal.mol}^{-1} \quad (-139.5 \pm 1.0 \text{ K.J.mol}^{-1})$$

From equation (18)

$$\Delta H_f^\circ \text{IO}_2\text{F}(\text{c}) = \Delta H_f^\circ \text{NaIO}_3(7500 \text{ H}_2\text{O}) + \Delta H_f^\circ \text{NaF}(7500 \text{ H}_2\text{O}) - 2 \Delta H_f^\circ \text{NaOH}(500 \text{ H}_2\text{O}) - \Delta H_R$$

Using ancillary data contained in table II - B.18.

$$\underline{\Delta H_f^\circ \text{IO}_2\text{F}(\text{c}) = -58.94 \pm 0.3 \text{ K.cal.mol}^{-1} \quad (-246.6 \pm 1.2 \text{ K.J.mol}^{-1})}$$

Table II - B.17

Enthalpy of Reaction of Iodyl Fluoride and
aqueous Sodium Hydroxide (0.100M)

	m(IO ₂ F) g	dilution, n	- ΔH _R	
			K.cal.mol ⁻¹	K.J.mol ⁻¹
1	0.3082	6413	32.79	137.2
2	0.2720	7267	33.27	139.2
3	0.2134	9263	33.64	140.8
4	0.1829	10807	33.10	138.5
5	0.1956	10106	33.20	138.9
6	0.2960	6678	33.49	140.12
7	0.2307	8568	32.86	137.49
8	0.2368	8347	34.18	143.0
9	0.2917	6776	33.63	140.7
10	0.4573	4322	33.17	138.8
11	0.3578	5524	33.44	139.9

Table II - B.18

Ancillary Data

Compound	$-\Delta H_f^\circ (\text{K.cal.mol}^{-1})$	Reference
H ₂ O	68.315 \pm 0.01	197
NaIO ₃ (7,500 H ₂ O)	112.28 \pm 0.1	198
NaF (7,500 H ₂ O)	135.90 \pm 0.1	198
NaOH (500 H ₂ O)	112.117 \pm 0.01	198

Iodine Pentafluoride, IF₅

The enthalpy changes associated with the reaction of liquid iodine pentafluoride and distilled water have been measured. The reaction was fast ($t < 1$ minute) and the slight acid mist produced above the solution quickly dissolved without any detectable effect upon the reaction trace. The reactant was contained in sealed evacuated ampoules. Corrections were made for the weight of air present in the empty ampoules and for the enthalpy of vaporisation. These corrections are outlined in Appendix III. No corrections were made for any heat of mixing of iodic and hydrofluoric acids or for the possibility of heat being evolved by the attack of dilute hydrofluoric acid on pyrex glass. Previous observations¹⁵⁸ using concentrations of up to three times in excess of any in this investigation were found to be negligible.

The enthalpy of reaction data for the reaction:

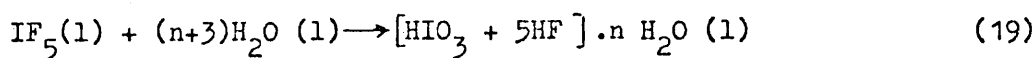

are recorded in table II - B.19.

Table II - B.19

Enthalpy of Formation of Iodine Pentafluoride

	m(IF ₅) g	dilution, n	- ΔH _{obs} (K.cal.mol ⁻¹)	ΔH _{corr} (K.cal.mol ⁻¹)	- ΔH _R (K.cal.mol ⁻¹)	-ΔH _f ^o (HF ₅ H ₂ O) (K.cal.mol ⁻¹)	-ΔH _f ^o (HIO ₃ .nH ₂ O) (K.cal.mol ⁻¹)	-ΔH _f ^o (IF ₅ l) (K.cal.mol ⁻¹)
1	0.4051	6086	22.49	0.19	22.30	77.245	53.02	212.00
2	0.3657	6742	22.87	0.21	22.66	77.265	53.02	211.74
3	0.9213	2676	22.61	0.09	22.52	77.132	52.98	211.18
4	0.8438	2922	22.37	0.10	22.27	77.144	52.99	211.50
5	0.4648	5305	22.96	0.17	22.79	77.222	53.02	211.40
6	0.4666	5284	22.97	0.17	22.80	77.222	53.02	211.39
7	0.5557	4437	22.92	0.14	22.78	77.195	53.01	211.26
8	0.3997	6169	23.15	0.19	22.96	77.246	53.02	211.35
9	0.5563	4432	22.74	0.14	22.60	77.195	53.01	211.44
10	0.5248	4698	22.85	0.15	22.70	77.203	53.01	211.38
11	0.6198	3978	22.83	0.13	22.70	77.179,	53.01	211.26

A modified procedure for calculating the enthalpy of formation has employed. One of the products of the hydrolysis of iodine pentafluoride is aqueous hydrogen fluoride, for which the enthalpy of dilution varies considerably. As this quantity also needs to be multiplied by five it is probably more accurate to calculate the enthalpy of formation of IF_5 at each particular dilution and then to obtain the standard deviation of the mean from these results. Accurate ΔH_f° ($\text{HF} \cdot n \text{H}_2\text{O}(l)$) data are now available²⁰¹. However, the existing data for ΔH_f° ($\text{HIO}_3 \cdot n \text{H}_2\text{O}(l)$) was insufficiently accurate (error limits of $\pm 1.005 \text{ K.cal.mol}^{-1}$ are quoted by Cox⁸⁸) and is only available to $n = 800$; a recent determination of $\Delta H_f^\circ \text{HIO}_3(c) = -55.41 \pm 0.10 \text{ K.cal.mol}^{-1}$ has been made by Howard and Skinner. Therefore, enthalpies of solution of iodic acid at varying dilutions have been measured and are contained in table II - B.20 and shown in figure II - B.2, from which ΔH_f° ($\text{HIO}_3 \cdot n \text{H}_2\text{O}(l)$) at each dilution of interest is recorded in table II - B.19.

From equation (19):

$$\Delta H_f^\circ \text{IF}_5(l) = \Delta H_f^\circ \text{HIO}_3 \cdot n \text{H}_2\text{O} + 5 \Delta H_f^\circ \text{HF} \cdot n/5 \text{H}_2\text{O} - 3 \Delta H_f^\circ \text{H}_2\text{O} - \Delta H_R$$

From table II - B.19

$$\text{Mean } \Delta H_f^\circ(\text{IF}_5(l)) = -211.45 \pm 0.14 \text{ K.cal.mol}^{-1}$$

Combining all error limits gives a final value:

$$\underline{\Delta H_f^\circ(\text{IF}_5(l)) = -211.45 \pm 0.27 \text{ K.cal.mol}^{-1} \quad (-884.7 \pm 1.1 \text{ K.J.mol}^{-1})}$$

Iodine pentafluoride is the only compound considered in this section for which previous thermochemical data are available. The enthalpy of hydrolysis was previously determined by Woolf in 1951. It was thought necessary to repeat these experiments as Woolf¹⁵⁸ carried out all measurements at about 20°C instead of 25°C and

Table II - B.20

Enthalpy of Solution of Iodic Acid

	*m(HIO ₃) g	dilution, n	+ ΔHsoln.	
			K.cal.mol ⁻¹	K.J.mol ⁻¹
1	0.96813	1004	2.523	10.556
2	0.30423	3195	2.419	10.121
3	0.23635	4112	2.402	10.050
4	0.206162	4715	2.398	10.033
5	0.130069	7473	2.383	9.970
6	0.09146	10627	2.365	9.895

* all weights were corrected to vacuum.

FIGURE: II-B:2 ENTHALPY OF SOLUTION OF IODIC
ACID VS. DILUTION.

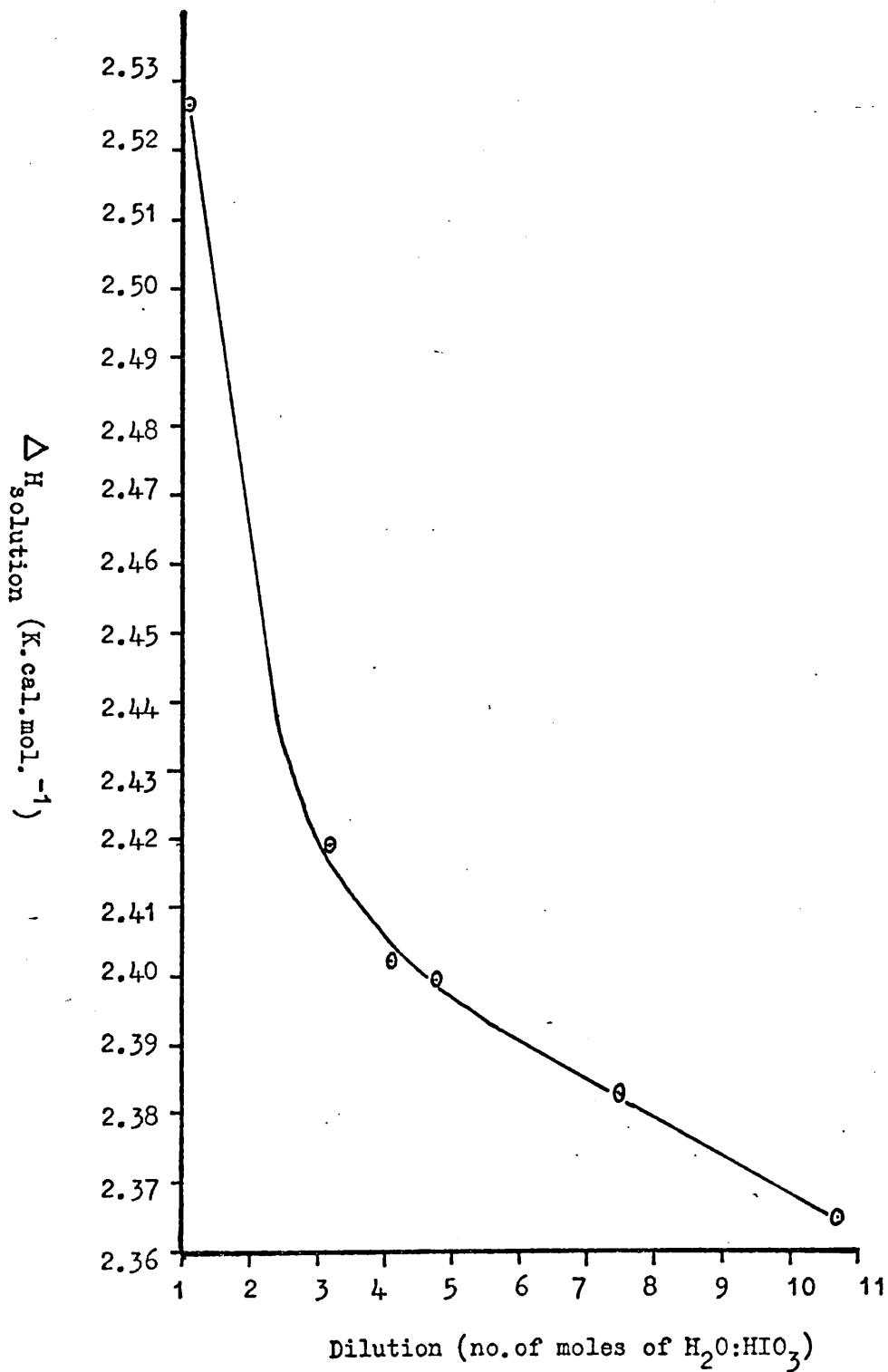

only a total of three results were recorded at various dilutions. Also, more accurate results should be obtained with modern thermistors and electronics as opposed to a Beckmann thermometer. Using the updated ancillary data Woolf's three results at 293°K are now:

$$\Delta H_{f293}^{\circ}(\text{IF}_5(1)) = -211.43, -211.21 \text{ and } -211.14 \text{ K.cal.mol}^{-1}$$

It is not possible to apply correctly these results for evacuated ampoules as few experimental details are given. Settle et.al., however, have corrected the results from 20°C to 25°C using the relevant heat capacity data. Thus, the enthalpy of formation of iodine pentafluoride using the enthalpy of hydrolysis of Woolf is given as:

$$\Delta H_f^{\circ}(\text{IF}_5(1)) = -211.6 \pm 0.3 \text{ K.cal.mol}^{-1}$$

The enthalpy of formation of IF_5 has also recently been determined¹⁵⁸ by fluorine-bomb calorimetry. Iodine was burned in an atmosphere of fluorine under varying pressures. The products, IF_5 and IF_7 , were obtained in proportions depending on the excess of fluorine employed. The amount of the more volatile IF_7 could be determined separately by chemical analysis. Assuming complete combustion, the amount of IF_5 could then be calculated using the original weight of iodine. The quantity of IF_5 could not be found by direct measurement as small amounts tended to adhere to the surface of the metal vacuum lines used. Thus, under mild fluorinating conditions, where only minimal amounts of the heptafluoride are produced, an accurate value of the energy of combustion of $\text{IF}_5(1)$ could be found. Application of a least-squares analysis of all the combustion data yielded a value for the standard energy of fluorination of $\text{IF}_5(1)$ to $\text{IF}_7(g)$. Therefore,

from these the following values were calculated:

$$\Delta H_f^\circ \text{IF}_5(\text{l}) = -210.79 \pm 0.39 \text{ K.cal.mol}^{-1} \text{ and } \Delta H_f^\circ \text{IF}_7(\text{g}) = -229.8 \pm 0.5 \text{ K.cal.mol}^{-1}$$

It can therefore be seen that the values of $\Delta H_f^\circ \text{IF}_5(\text{l})$ obtained in this investigation, that of Woolf and by the independent method of combustion all agree to within the limits of experimental error.

The values of ΔS_f° and ΔG_f° of $\text{IF}_5(\text{g})$ and $\text{IF}_5(\text{l})$ can be derived from $\Delta H_f^\circ \text{IF}_5(\text{l})$ using the appropriate ancillary data. This procedure has been carried out by Settle et.al.¹⁵⁹

The knowledge of the enthalpies of formation of iodine fluorides enables the calculation of bond energy terms. Bond energy terms are the quantities assigned to each of the bonds in a molecule such that the sum over all bonds is equal to the enthalpy change associated with the conversion of the molecule into separate atoms. Reactants and products being in their ideal gas states at one atmosphere pressure and 298.15°K. The thermodynamic cycle for the formation of a gaseous iodine fluoride, IF_n , from its elements is shown below in figure II - B.3.

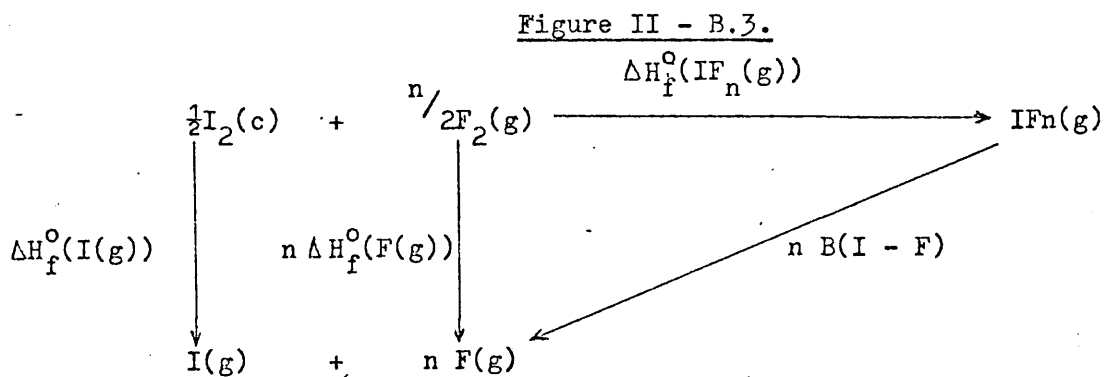

$\Delta H_f^\circ(\text{I}(\text{g}))$ = standard enthalpy of atomisation + dissociation enthalpy

$\Delta H_f^\circ(\text{F}(\text{g}))$ = dissociation enthalpy

$\text{B}(\text{I} - \text{F})$ = bond energy terms.

From figure II - B.3.

$$B(I - F) = \frac{\Delta H_f^\circ(I(g)) + n \Delta H_f^\circ(F(g)) - \Delta H_f^\circ(IF_n(g))}{n}$$

n

Thus, using the ancillary data contained in table II - B.22 the bond energy terms of iodine fluorides have been calculated and are displayed in table II - B.21. It can be seen from the results of the mono-, penta- and heptafluorides that the bond energy terms decrease with increasing oxidation state. This observation is in accord with other known examples: (ClF, 61.3; ClF₃, 41.2¹¹⁰; PCl₃, 79; PCl₅, 63¹⁹³ [K.cal.mol⁻¹]). The apparent low value of IF, if the enthalpy of formation is correct, would be expected with such an usually long bond length (IF = 1.91Å; IF₅ = 1.86, 1.75Å; and IF₇ = 1.81, 1.84Å).

Table II - B.21

Bond Energy Terms of Iodine Fluorides

Compound, IF _n	- ΔH _f ^o (IF _n (g))	B(I - F)	
		K.cal.mol ⁻¹	K.J.mol ⁻¹
IF	-22.6 ^a	67.0	280.3
IF ₃	-	-	-
IF ₅	-201.49 ^{b,c}	64.3	269.0
IF ₇	-229.8 ^d	55.4	231.8

a Reference 119

b Δ H_f^oIF₅(l) this investigation

c Δ H_{vap} 298 IF₅ Reference 160

d Reference 159

Table II - B.22

Ancillary Data

	F	I	Reference
$\Delta H_f^\circ(X_2(g))(K.cal.mol^{-1})$	0	14.9	193
Dissociation enthalpy	37.8	36.2	193
$\Delta H_f^\circ(X(g))(K.cal.mol^{-1})$	18.9	25.5	193
$\Delta H_{vap}(298.15^\circ K) IF_5 = 9.96 K.cal.mol^{-1}$			160

SECTION III

EXPERIMENTAL

III - A Preparations and Analyses

Dioxodifluoriodate Salts, MIO_2F_2

Dioxodifluoriodate salts were prepared by the method of Weinland et.al.^{2,3} as follows: 35g. of the appropriate iodate were dissolved in 75ml of 40% hydrofluoric acid (B.D.H.Ltd.) in a polythene beaker by stirring for several minutes with a polythene spatula. The clear solution was then allowed to stand in a well ventilated fume cupboard for several days. On evaporation of the liquid colourless crystals formed. The beaker was then transferred to a dry-box and the remaining few millilitres of solvent were decanted off. To remove the last traces of the acid the crystalline product was washed several times with dry diethyl ether and then dried in a stream of dry nitrogen. The crystals were stored in polythene sample tubes.

Table III - C.1.

Analysis Results of Dioxodifluoriodate Salts

Compound	Found(%)		Calculated(%)	
	I	F	I	F
NaIO_2F_2	57.7	17.3	57.7	17.3
KIO_2F_2	53.8	16.0	53.8	16.1
RbIO_2F_2	45.2	13.4	44.9	13.5
CsIO_2F_2	44.1	13.4	38.5	11.5
$\text{NH}_4\text{IO}_2\text{F}_2$	59.1	17.4	59.0	17.7

It can be seen from the above table that good agreement exists between the found and calculated results for all the salts except caesium. The preparation procedure for the caesium salt was identical to that outlined before. However, when the colourless crystals obtained after the evaporation of the solvent were washed with dry diethyl ether a reaction appeared to occur at the crystal surface. Thus, to avoid any possible contamination the crystals were placed over phosphorus pentoxide and sodium fluoride in a vacuum desiccator and allowed to dry. However, the analysis results from several preparations proved to be consistent with the value quoted.

The iodates of potassium (B.D.H. Ltd.), sodium (Hopkins & Williams Ltd.) and ammonium (John Roes Chemicals) are all commercially available. However, rubidium and caesium iodates were unobtainable and had thus to be prepared from the carbonates by the method of Wheeler and Penfold²⁰³.

Rubidium iodate was prepared by adding a strong aqueous solution of rubidium carbonate (B.D.H. Ltd.) to a hot strong aqueous solution of iodine pentoxide (B.D.H. Ltd.) in equal molar proportions. A fine white precipitate was produced on cooling. The solid was filtered, washed with a little water, and dried at 100°C.

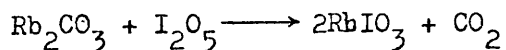

Analysis: found: I, 49.2%; RbIO_3 requires: I, 48.7%

Caesium iodate was prepared by the addition of a moderately strong aqueous solution of iodic acid (B.D.H. Ltd.) to a strong solution of caesium carbonate (B.D.H. Ltd.), the carbonate being in slight excess. The solution was then boiled and a white precipitate

appeared on cooling. This was then filtered, washed with a little water and dried at 100°C.

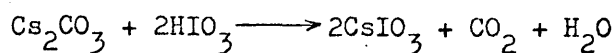

Analysis: found: I, 41.0%; CsIO₃ requires 41.2%

Iodine Oxygen Trifluoride, IOF₃

The iodine pentafluoride used in these experiments was supplied in metal cylinders (Matheson Co. Ltd.). It was contaminated with iodine which was removed by shaking with mercury. Although IF₅ is known to react slowly with mercury at room temperature, the reaction with iodine is rapid. The apparatus used for the purification is shown in figure III - A.1. It consisted essentially of a vacuum line of two gas traps, A and B. Each inlet and exit arm of the traps contained a greased stopcock. An additional stopcock, F, was glassblown onto the exit arm of trap B. The B29 test tubes of A and B were modified to hold larger quantities of liquid by the addition of 50ml flask to the ends. All the horizontal connections in the vacuum line were made by means of S19 ball and socket joints in order to give greater flexibility. Due to the high reactivity of IF₅, Kel-F grease (3M Co.) was used for all greased stopcocks and joints.

Approximately 30ml of IF₅ were distilled from the attached metal cylinder into trap A which was maintained at -80°C (solid carbon dioxide and acetone) to remove one of the probable impurities, hydrogen fluoride. Iodine was removed by carefully shaking the liquid with about 5ml of triply distilled mercury contained in trap A. The IF₅ was again fractionated at -80°C into trap B, which by means of the greaseless socket (J. Young (Scientific Glassware) Ltd.) attached to the stopcock F

FIGURE: III-A.1 VACUUM SYSTEM FOR THE PURIFICATION OF IODINE PENTAFLUORIDE

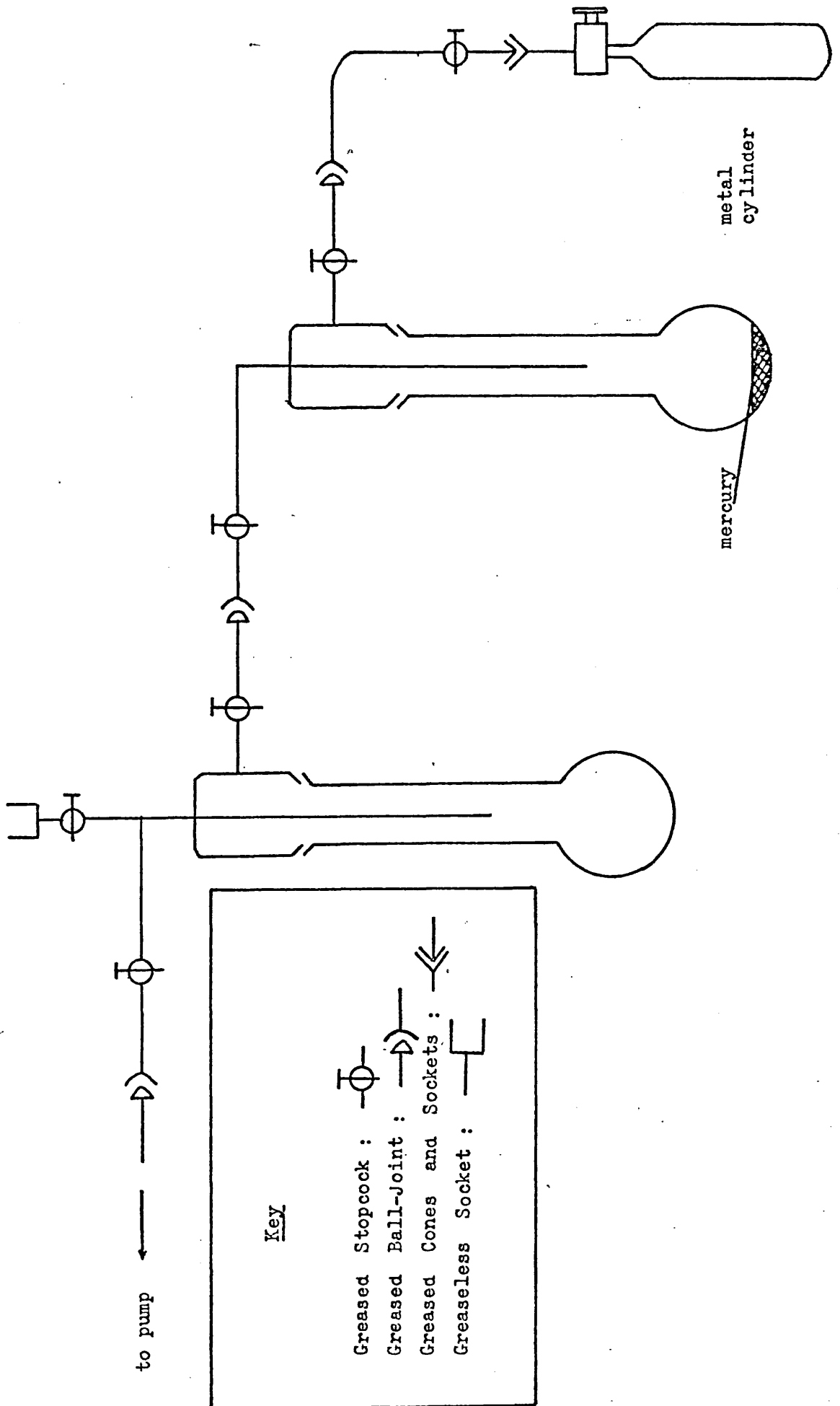

connected to the greaseless vacuum line (figure III - A.2.).

The IF_5 was stored in one of the evacuated storage vessels shown at -196°C .

After purification the iodine pentafluoride was always handled in the greaseless vacuum line shown in figure III - A.2. The line was capable of achieving pressures of 10^{-4} torr or below. Vapour pressures were measured by means of a Pirani gauge (Edwards High Vacuum Ltd.). The vacuum taps were of the "Uniform" type (Glass Precision Engineering Co. Ltd.) with teflon plungers giving teflon-to-glass seals. The greaseless cones and sockets contained a teflon "O" ring backed by one of viton (J. Young (Scientific Glassware) Ltd.). Thus the iodine pentafluoride came in contact only with teflon and glass throughout these experiments. The analysis of the IF_5 was carried out in sealed ampoules (see Section III - C.)

Analysis: IF_5 : found I, 57.2%. F, 42.6%; required I, 57.2%; F, 42.8%

Iodine oxygen trifluoride was prepared by the reaction of iodine pentafluoride with iodine pentoxide. To avoid any possible contamination of the IF_5 due to hydrolysis or reaction with grease the preparation was carried out in a greaseless environment and under high vacuum. The apparatus for the preparation (figure III - A.3.) consisted of a 50ml flask glassblown onto a stem containing a greaseless tap. Approximately 2.5g of iodine pentoxide (B.D.H. Ltd.), which had been dried at 100°C for 24 hours, were placed through the barrel of the tap into the reaction vessel together with a small teflon-coated magnetic follower. The vessel was attached to the vacuum line and evacuated iodine pentafluoride

FIGURE : III-A.2 GREASELESS VACUUM SYSTEM FOR HANDLING IODINE PENTAFLUORIDE

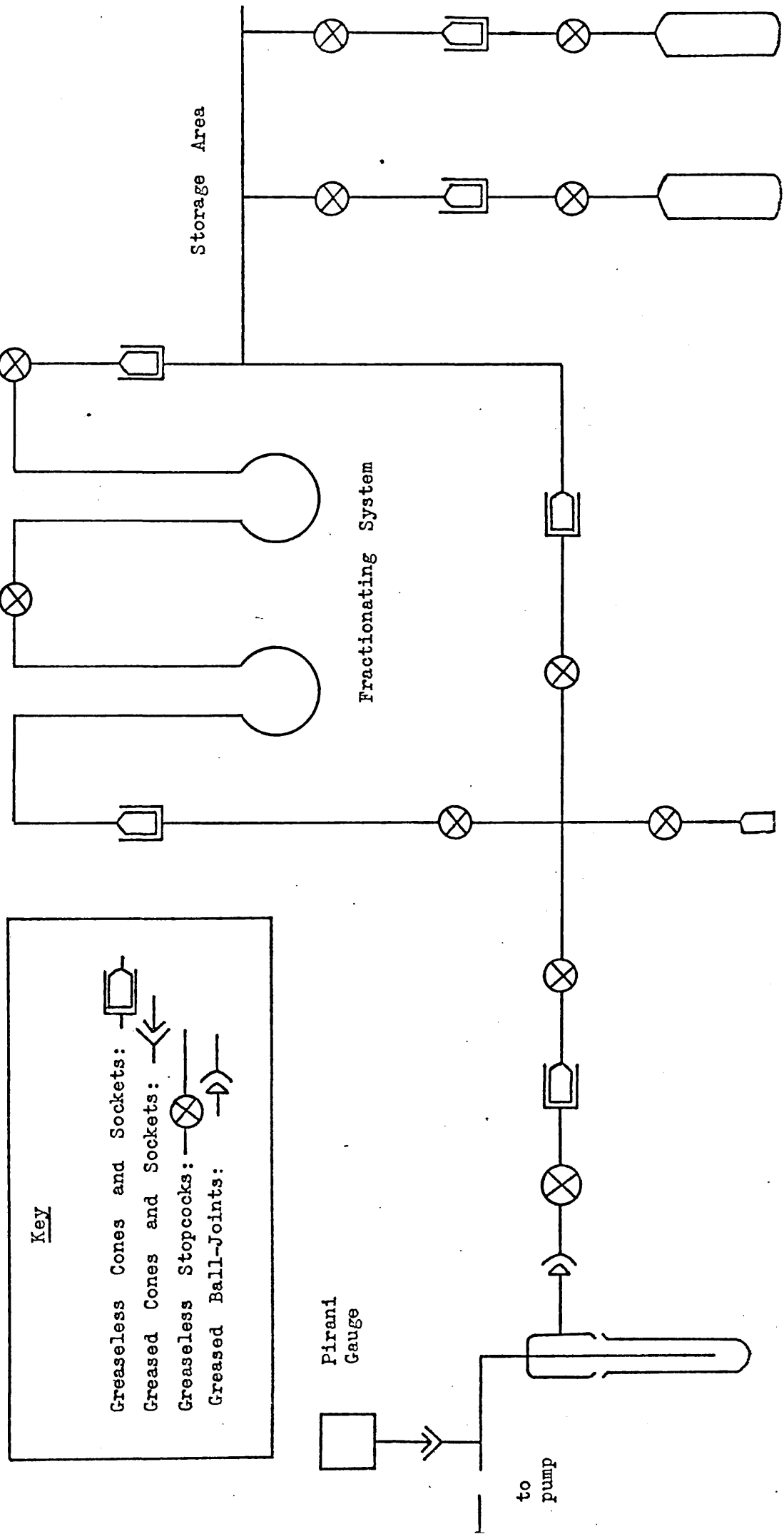
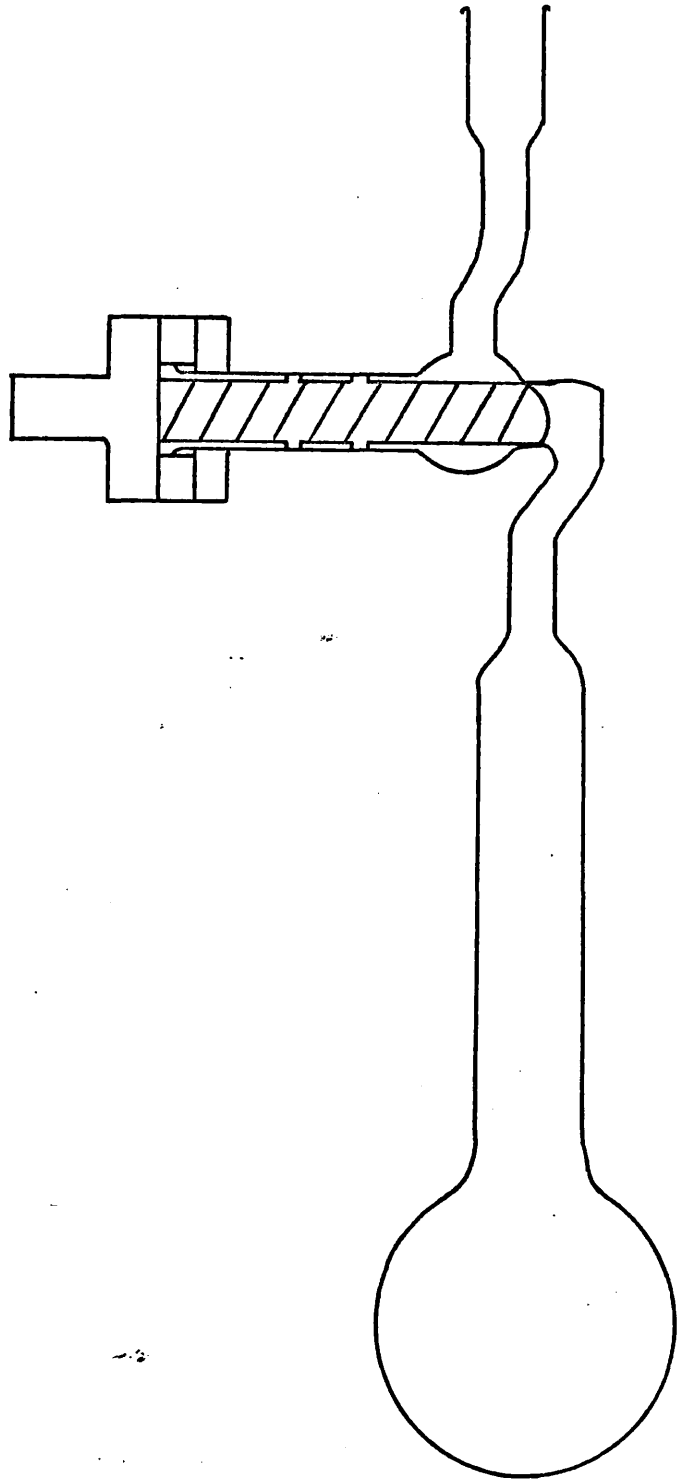
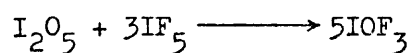

FIGURE: III-A.3 REACTION VESSEL



(30ml), which had been fractionated twice at -80°C to remove any hydrogen fluoride, was distilled into the reaction vessel. The tap of the vessel was then closed and it was removed from the vacuum line. By means of an oil bath and stirrer hotplate the temperature of the reaction mixture was gradually raised, with constant stirring, to approximately 100°C . After about thirty minutes at this temperature the final solid traces had disappeared. On standing at room temperature for some time white needle-like crystals could be seen. The excess IF_5 was transferred back into a storage vessel and the remaining solid pumped for about one hour. The very reactive crystals were removed from the reaction vessel by means of the tap barrel in a dry box. Due to the rapid deterioration of the sample on standing at room temperature it was kept in a sealed evacuated storage vessel at -196°C .



Analysis: IOF_3 : found I, 63.6%; F, 27.6%, required I, 63.5%; F, 28.5%

Iodyl Fluoride, IO_2F

Iodyl fluoride was prepared by the method described by Aynsley²⁵. After the removal of excess iodine pentafluoride from a sample of iodine oxide trifluoride obtained in the previous reaction, an oil bath was placed around the bulb of the reaction vessel (figure III - A.3.). The temperature was gradually raised to 110°C with the vacuum system open to the pump. After one hour at this temperature the vessel was sealed and removed from the line. The white solid obtained was handled in the dry nitrogen atmosphere of a dry box.

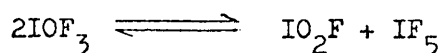

Analysis: IO_2F : found I, 71.6%; F, 10.8%; required I, 71.3%; F, 10.7%

To verify that the above equation is correct the other product of the reaction, IF_5 , was isolated, weighed and analysed. This procedure was carried out by allowing the volatile product to condense into an ampoule cooled to -196°C , the vacuum system being closed to the pump. The ampoule arrangement was identical to that described in section III - C.

Analysis: IF_5 : found, I, 57.0%; F, 41.7%; required I, 57.2%; F, 42.8%

The preparation of complexes of iodyl fluoride have been attempted without using elemental fluorine or anhydrous hydrogen fluoride.

It has been stated¹ that if iodyl fluoride is refluxed with an excess of sulphur trioxide the compound iodyl fluorosulphate is formed:

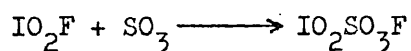

Approximately 1g of iodyl fluoride was refluxed at 50°C with 30ml of sulphur trioxide (Hardman & Holden) under an atmosphere of nitrogen with constant stirring. All joints of the apparatus were greased with Kel-F (3M Co.). The solvent of the resulting yellow solution was then removed under vacuum at 40°C . However, difficulty was experienced in the removal of the sulphur trioxide due to the formation of asbestos-like polymers. A yellow solid was obtained after continual pumping at 40°C and the physical removal of the white polymers.

Analysis: $\text{IO}_2\text{SO}_3\text{F}$: found, I, 29.5%; required I, 49.2%

After several unsatisfactory preparations involving sulphur trioxide it was decided to use fluorosulphonic acid, HSO_3F , as the reactant. Approximately 30ml of HSO_3F (Fluorochem.Ltd.) was distilled at 163°C under an atmosphere of dry nitrogen, into a flask containing 1g of iodyl fluoride. The solid dissolved with stirring to give a yellow solution. To ensure complete reaction the temperature was raised to 60°C for one hour. The excess acid was then removed by vacuum distillation. However, the resulting yellow solid, even when heated to 60°C , could not be pumped to complete dryness and remained as a paste. This solid was found to decompose to iodine at about 80°C . For the analysis it was found necessary to hydrolyse the solid in strong alkali and then boil the solution for three hours. This procedure is necessary as one of the initial hydrolysis products is fluorosulphonic acid which hydrolyses only very slowly to produce the fluoride and sulphate ions.

Analysis: $\text{IO}_2\text{SO}_3\text{F}$: found, I, 41.7%; F, 4.3%; required I, 49.2%; F, 7.4%

It can thus be seen that no satisfactory preparation of pure $\text{IO}_2\text{SO}_3\text{F}$ was found. The compound peroxydisulphuryl difluoride would seem the most suitable reagent for preparing the iodyl compound, as has been shown by Aubke et.al.³⁹.

The preparation of the complex iodyl hexafluorophosphate $\text{IO}_2^+\text{PF}_6^-$, has been attempted. Phosphorus pentafluoride was obtained from the reagent 'Phosfluorogen A' (Ozark-Mahoning Co.) which has the composition p-chlorobenzediazonium hexafluorophosphate, $\text{p-ClC}_6\text{H}_4\text{N}_2\text{PF}_6$. Approximately 25g of 'Phosfluorogen A' were placed in a flask connected to a vacuum system consisting of two gas traps.

The system was evacuated. The gas trap adjacent to the flask was cooled to -80°C with a solid carbon dioxide and acetone slush bath and the second trap was maintained at -196°C . By means of an oil bath the flask was gradually heated. At temperatures approaching 150°C the 'Phosfluorogen A' melted and decomposed. Of the decomposition products, nitrogen passed through both traps, phosphorus pentafluoride was retained at -196°C and para-chlorofluorobenzene, $\text{p-ClC}_6\text{H}_4\text{F}$, was retained at -80°C . By closing stopcocks connected to the inlet and exit arms of the gas traps the 10g of PF_5 could be isolated. On warming the PF_5 was allowed in a closed system to distil into a reaction vessel (figure III - A.3.) with a 25ml bulb containing 0.5g of iodyl fluoride. After completion of the transfer the vessel was sealed and the liquid nitrogen bath exchanged for one of solid carbon dioxide and acetone at -80°C . At this temperature PF_5 is a liquid (b.p. -75°C , m.p. -83°C). The contents of the vessel were stirred at -80°C for one hour. The PF_5 was then removed under vacuum. Analysis of the remaining white solid, however, was consistent with iodyl fluoride and thus no reaction could be detected.

Aynsley has reported the formation of a complex between iodyl fluoride and antimony pentafluoride of the composition $\text{IO}_2\text{F} \cdot 0.8 \text{SbF}_5$ ³⁸. Approximately 20ml of antimony pentafluoride (Koch-Light Ltd.) were fractionated at -80°C to remove any possible hydrogen fluoride contaminant. The liquid was then heated with 1g of iodyl fluoride to 80°C and maintained at that temperature for one hour with constant stirring. A blue solid remained after the evaporation of the excess antimony pentafluoride. The analysis of this solid, however, proved very difficult. Only a small amount of

iodine was precipitated on the addition of potassium iodide to an acidified solution (see analysis procedure). The presence of antimony complicates the reaction scheme which has been generally represented²⁰⁴ as follows :

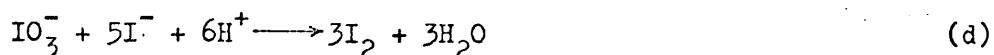
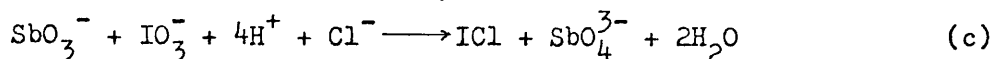
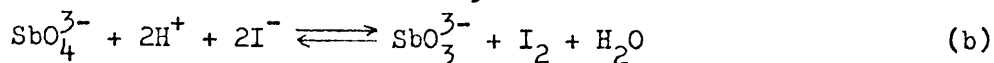
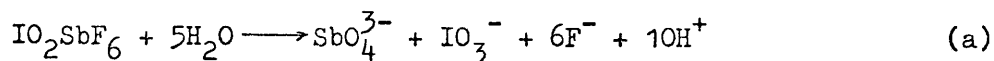

Without definite knowledge of the final state of the hydrolysis products no meaningful conclusions can be made of the analysis results. Although Aynsley³⁸ postulated a formation of $\text{IO}_2\text{F} \cdot 0.8\text{SbF}_5$ no analytical details were given. However, if one considers only reaction (c) no iodine would be produced. Thus, by titrating the resulting iodine an approximate composition of $\text{IO}_2\text{F} \cdot 0.8\text{SbF}_5$ is produced. However, one reaction perhaps should not be considered in isolation.

Hexafluoroiodate Compounds, MIF_6

The preparation of hexafluoroiodate compounds has normally involved the reaction of the respective fluoride with iodine pentafluoride^{134, 166-171}. An alternative preparation also has been reported¹²⁹ of the iodides with iodine pentafluoride. The former reaction was first attempted.

The fluorides used in the experiments were crushed and dried before use, CsF (B.D.H. Ltd.) at 500°C for 24 hours and KF (B.D.H. Ltd.) and RbF (Alfa Inorganics) at 110°C for 24 hours. After drying, the materials were handled in the dry nitrogen atmosphere of a glove box due to their hygroscopic nature. The

reaction procedure was identical to that used in the preparation of IOF₃ with approximately 5g of solid and 30ml of IF₅. The resulting solids, after evaporation of the solvent, tended to adhere to the surface of the reaction vessel and could only be removed by cutting the vessel in a dry box. After several attempts the hexafluoroiodate compounds were not prepared to within the limits of purity required for calorimetric measurements. The reaction was thus abandoned in favour of that between the iodides and IF₅.

Potassium (May & Baker Ltd.), rubidium (B.D.H. Ltd.) and caesium (B.D.H. Ltd.) iodides were all dried before use at 110°C for 24 hours. Approximately 5g of the iodide were reacted with 30ml of iodine pentafluoride in the reaction vessel shown in figure III - A.3. Iodine was immediately liberated on contact of IF₅ with the iodide. The reaction mixture was heated to 100°C for thirty minutes with constant stirring and then rapidly cooled with an ice bath. The iodine pentafluoride was removed under vacuum leaving a red solid due to contamination by iodine. After continual pumping at 50°C for several hours the final traces of iodine were removed leaving a white powder.

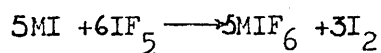

Analysis: KIF₆: found, I, 45.2%; F, 40.5%; required, I, 45.3%; F, 40.7%

RbIF₆: found, I, 39.0%; F, 34.8%; required, I, 38.9%; F, 34.9%

CsIF₆: found, I, 34.1%; F, 30.5%; required, I, 34.0%; F, 30.5%

Iodic Acid, HIO₃

AnalaR iodic acid (B.D.H. Ltd. min. 99.5%) was used for the heats of solution data contained in section II - B. Before use it

was crushed and dried in a desiccator for one week. The exact purity was determined with 0.1N sodium thiosulphate (B.D.H. Ltd.) that had been standardised with dried AnalaR potassium iodate (B.D.H. Ltd. min. 99.9%). The purity of the sample of iodic acid was found to be 99.9%.

Analytical Procedures

All the compounds described in this section hydrolyse to iodate and fluoride ions in dilute alkali. Of the compounds discussed only the adducts of iodyl fluoride do not hydrolyse rapidly.

Iodine Analysis

Iodine was precipitated by the addition of excess potassium iodide (May & Baker Ltd.) to a solution of the hydrolysis products that had been acidified with 2N hydrochloric acid.

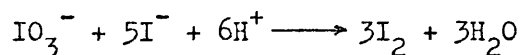

Thus, one sixth of the iodate produced is from the hydrolysed compound. The liberated iodine was titrated against standard 0.1N sodium thiosulphate (B.D.H. Ltd.). When the colour of the solution had changed from red to yellow it was diluted with distilled water and freshly made starch solution added. The titration was continued until the solution colour changed from blue to colourless.

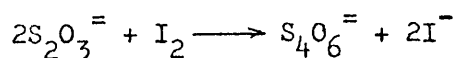

Thus, 2 moles of thiosulphate are equivalent to 1 mole of iodine. From the titration results the percentage of iodine in the hydrolysed compound, knowing the initial weight used, can now be determined.

Fluorine Analysis

Fluorine analysis were undertaken using a Specific Ion Meter (Orion model 401) coupled to a combination fluoride electrode (Orion model 96-09). The determinations were carried out in alkaline solutions. As the electrode responds to hydroxide ion at low fluoride concentrations and pH of 9.5 or above a buffered solution had to be added. To adjust the pH to between 5 and 6 a 4M buffered potassium acetate solution was used. This solution was prepared with two parts of 6M acetic acid diluted with one part of distilled water. 50% potassium hydroxide solution was slowly added with stirring to the ice-cooled acetic acid until a pH of 5 was reached (measured by means of a calibrated pH meter). All standard and sample solution were diluted 10 : 1 with the buffered solution. The standards were prepared from a background solution containing all components except fluoride. AnalaR sodium fluoride (B.D.H. Ltd. min 99.0%) was used in the preparation of all standard solutions. Two standards were selected in the concentration range of the unknown, the first a multiple of ten of the second, e.g. if the unknown was expected to have a fluoride ion concentration of $5 \times 10^{-3} \text{M}$ then standards of 10^{-3}M and 10^{-2}M were used. All solutions were stirred during the determinations.

Standard filling solution (Orion 90-00-01) was added to the combination fluoride electrode which was connected to the meter. The electrode was first inserted into the higher concentration standard. The meter was calibrated such that the needle rested at the mid-scale reading of the logarithmic scale i.e. at a reading of 100. The electrode was removed, carefully blotted with absorbent tissue and placed into the second standard. The meter was then

calibrated to a needle reading of 10. The electrode was removed, blotted and placed in the unknown sample solution. A direct reading of the fluoride ion concentration could then be made from the reading of the logarithmic scale. From the concentration of the fluoride ion in solution the percentage of fluorine in each compound, knowing the original weight used, could thus be calculated.

III - B Spectroscopy

Raman Spectra

Solid-state Raman spectra obtained using a Cary 81 Spectrometer. A Spectra-Physics helium-neon laser (6328Å) was used for excitation. The scattered radiation was detected at 180° to the incident beam. The solid samples were crushed and loaded in an atmosphere of dry nitrogen into flat-ended capillary tubes which were subsequently sealed. The samples of IOF₃ were found to decompose in the capillary tubes at room temperature. Thus, the tubes were maintained at -196°C until the recording of the spectrum.

Infrared Spectra

Solid-state infrared spectra in the range 1000 - 190 cm⁻¹ were obtained using a Perkin-Elmer 325 spectrometer. The samples were normally run as nujol mulls between caesium iodide plates. However, for the more reactive compounds other methods had to be employed. Other mulling agents including Kel-F grease (3M Co.) and hexachlorobutadiene were tried but were found to absorb in the spectral regions of interest. Discs of IOF₃ with potassium

chloride were also unsuccessful. Dry powders between silver chloride plates were found to give satisfactory quality spectra for the compounds ' IO_2SbF_6 ' and ' $\text{IO}_2\text{SO}_3\text{F}$ '.

The lower frequency infrared bands of KIO_2F_2 were recorded from $40 - 420 \text{ cm}^{-1}$ using a R.I.I.C. interferometer model FS 720. The solid sample was run as a polythene disc.

N.M.R. Spectra

^{19}F N.M.R. spectra were obtained using a Varian HA-60-IL instrument (56.4 MHz) with variable temperature facilities.

A solution of KIO_2F_2 in 48% aqueous hydrofluoric acid was placed in a teflon n.m.r. tube (N.M.R. Specialists) by means of a plastic syringe with a stainless steel needle. The teflon tube was placed inside one of pyrex together with a small quantity of tri-fluoroacetic acid as the external reference.

IOF_3 was loaded into a pyrex n.m.r. tube, connected to a greaseless socket, in a dry box. A closed teflon tap was attached to the tube by means of a greaseless cone. The tube was then connected to the vacuum line (figure III - A.2.) and evacuated. IF_5 (previously fractionated twice at -80°C) was distilled under vacuum into the tube, which was then sealed. The tube was warmed and carefully shaken to allow the solid to dissolve.

Mass Spectra

The mass spectra of iodyl fluoride were obtained using a Perkin-Elmer R.M.S. - 4 instrument. The solid samples were loaded into quartz dippers in a dry nitrogen atmosphere and inserted into the instrument by means of a probe.

III - C Calorimetry

Calorimetry involves the measurement of the temperature change (or change of some temperature-dependent property) associated with a defined reaction or physical transformation of a known quantity of compound. The system may then be calibrated by the introduction of a known amount of heat and the temperature-related change again measured. The enthalpy change associated with chemical reaction or physical change can then be found from these two temperature changes.

Calorimeters

Two solution reaction calorimeters were used in the course of this work. (a) Enthalpies of reaction were determined by means of a calorimeter designed and constructed in this laboratory. (b) Enthalpies of solution were determined by a commercial LKB 8700-1 Precision Calorimetry System.

- (a) The calorimeter was operated in duplicate in the isoperibol mode and detailed accounts of the construction and operating procedures are available^{205,206}.

The calorimeter cell (figure III - C.1) consisted of pyrex dewar vessels with the vacuum jackets evacuated and sealed at 10^{-6} mm. of Hg. The lids of the vessels were attached by means of glass flanges lightly lubricated with silicone grease. B10 and B14 sockets in the lids allowed the introduction of the various components into the calorimeter cell. During the course of the experiments the cells were immersed to the base of the 'quickfit' sockets in a constant temperature bath maintained at $25.00 \pm 0.01^{\circ}\text{C}$. Equilibrium times of the order of one hour before the reaction and calibration experiments were used. Cooling of the calorimeter cells

FIGURE: III-C.1 CALORIMETER CELL

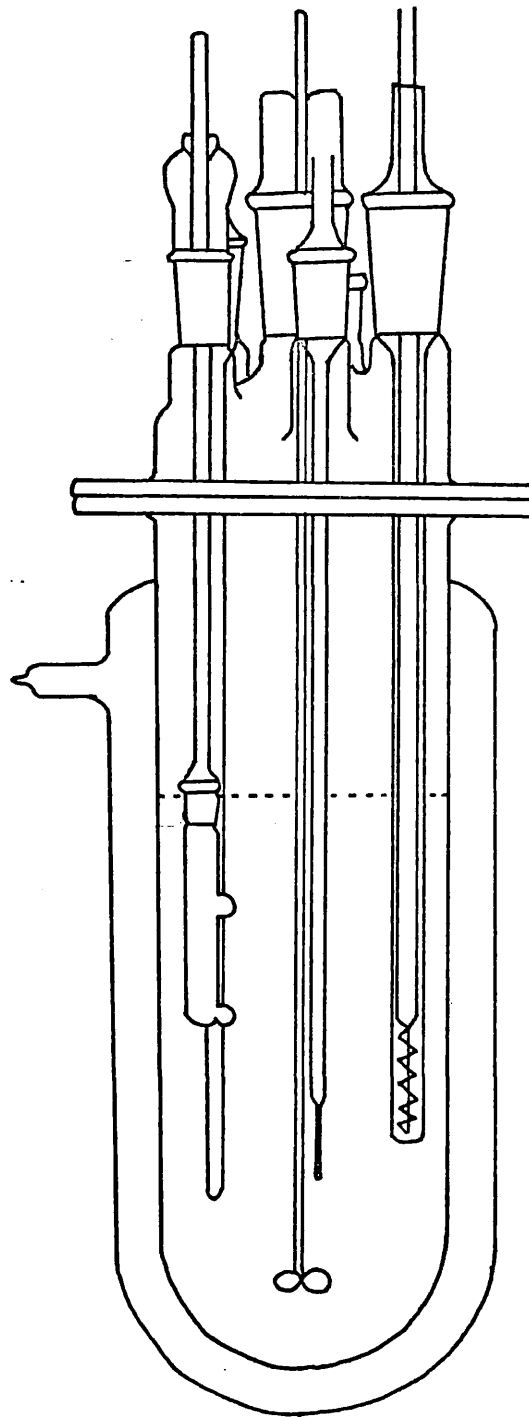

between the reaction and calibration was achieved by the introduction of small quantities of liquid nitrogen to the cooling tube.

Heaters of measured power were used to achieve the desired temperature rise during calibration experiments. These heaters consisted of a spiral of wire wound around an alumina former. The unit was contained in a thin glass sheath filled with light paraffin oil in order to give good thermal conductivity. The heater current was supplied from a 6V constant potential source.

Temperature changes were detected by means of a thermistor (F53, Standard Telephones and Cables Ltd.) which formed one arm of a Wheatstone Bridge circuit (figure III - C.2(a).) The out-of-balance bridge potential was measured by means of a chart recorder (Bryans Ltd., model 27000). It has been shown²⁰⁷ that the displacement from the mid-scale of the chart recorder is linear with respect to changes in the thermistor resistance. Thus, by adjusting the sensitivity controls for each thermistor resistances could be read off directly using a scale $1\Omega \equiv 1\text{cm}$ of chart paper $\cong 0.006^\circ\text{C}$.

The two types of ampoules used are shown in figure III - C.3. The ampoule (a) was used for solid samples. It consisted of a thin-walled B7 test tube with two very thin glass bulbs. The upper bulb was always above the surface of the solid sample so that on breaking the calorimeter liquid could flow through the ampoule and ensure good mixing. As all samples used in this investigation were hygroscopic the loading of the ampoules was carried out in a dry-box. To avoid any weighing errors due to loss of grease the arrangement shown in figure III - C.(a) was

FIGURE: III-C.2(a) CALORIMETRIC WHEATSTONE BRIDGE

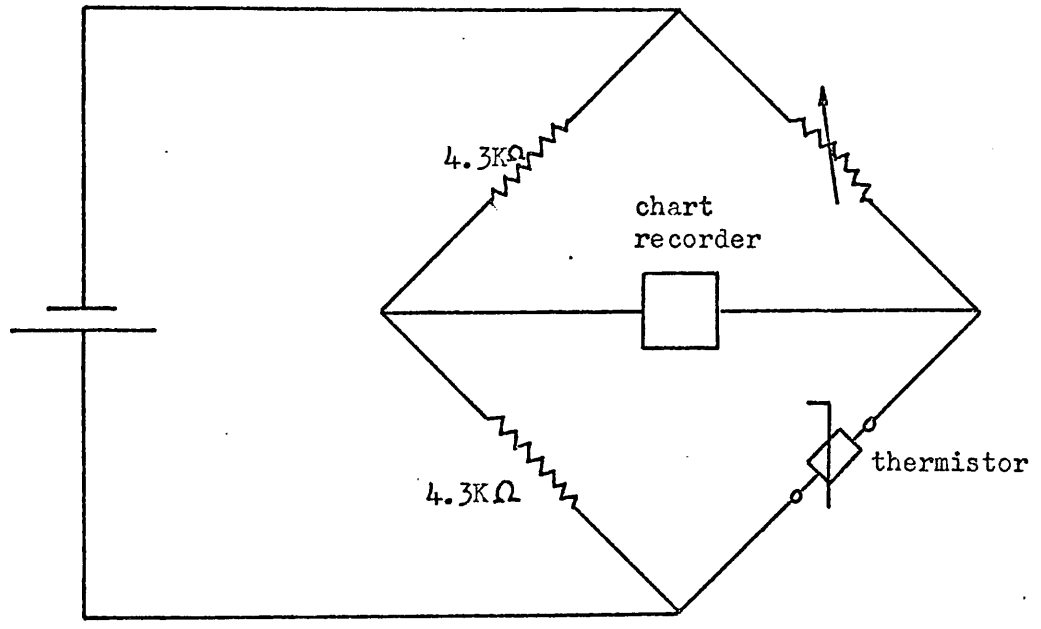

FIGURE: III-C.2(b) CALORIMETRIC HEATER CIRCUIT

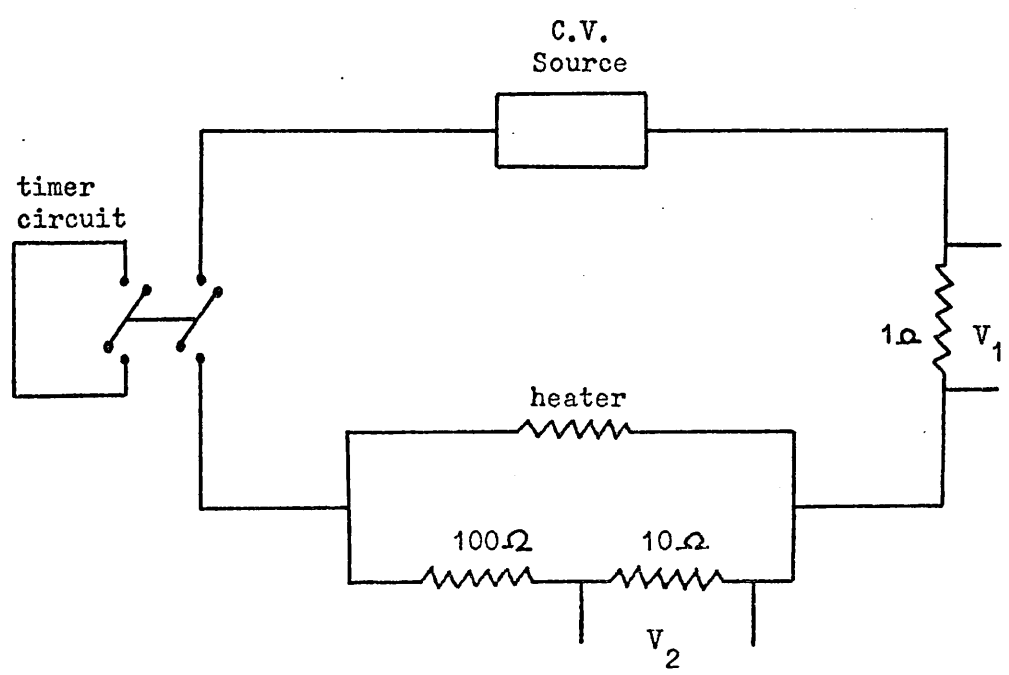
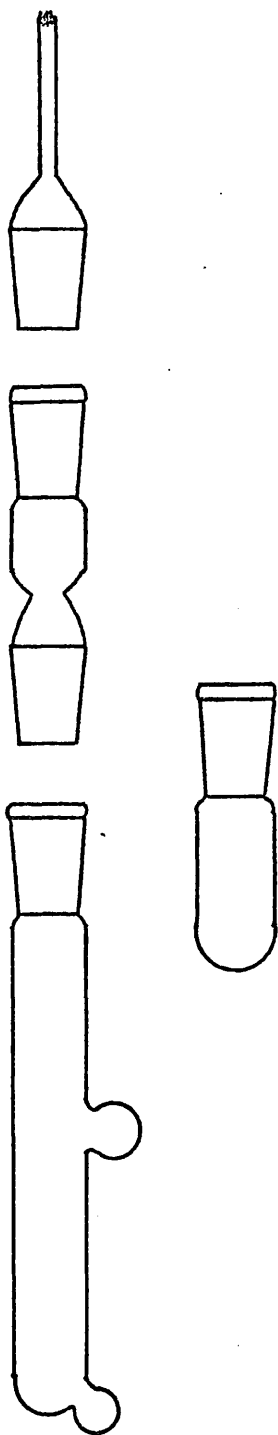

FIGURE: III-C.3 CALORIMETRIC AMPOULES

(a) Solids

(b) Vacuum-Filled(Liquids)



used. A B7 stopper was glassblown onto a B7 socket. The stopper was greased and inserted into the small B7 test tube shown which were weighed together with the empty ampoule to $\pm 0.0001\text{g}$. The ampoule was then loaded in a dry-box and the stopper inserted. The stoppered ampoule and the test tube were then again weighed.

The ampoule shown in figure III - C.3.(b) was the type used for samples filled under vacuum, i.e. iodine pentafluoride. The ampoule was constructed with a thickened glass constriction in the stem to aid its sealing. The volume of each ampoule was measured before use by weighing it empty and then with water filled to the constriction. The volume is needed in order to calculate the correction for the weight of air present in the empty, unevacuated, ampoule. The ampoule was attached to the greaseless vacuum line by means of a greased B7 cone joined to a greaseless socket. This arrangement also eliminated weighing errors due to loss of grease as it was attached to the ampoule throughout all weighings. The ampoule was evacuated very slowly to prevent the bulbs imploding. Iodine pentafluoride was then condensed in by cooling the bottom bulb in liquid nitrogen and carefully sealing with a small flame. After warming to room temperature the sealed ampoule was weighed again.

The heat due to ampoule breaking was shown to be negligible from blank calorimetry runs.

Actual temperatures were not calculated in this investigation but the ratio of the temperature differences for the reaction and calibration periods were calculated from the resistance measurements. Typical reaction and calibration temperature-time profiles are shown in figure III - C.4.(a) and (b)

(a) Reaction.

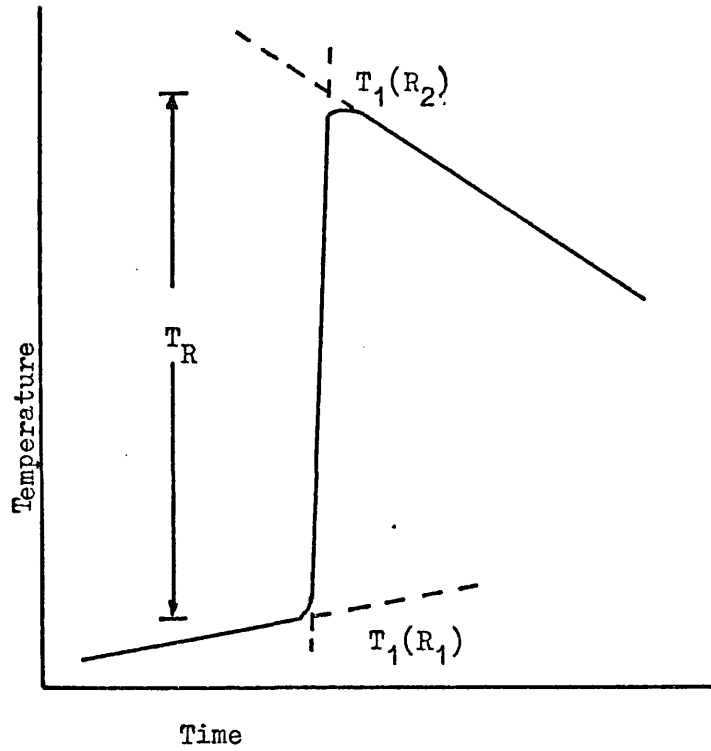

(b) Calibration.

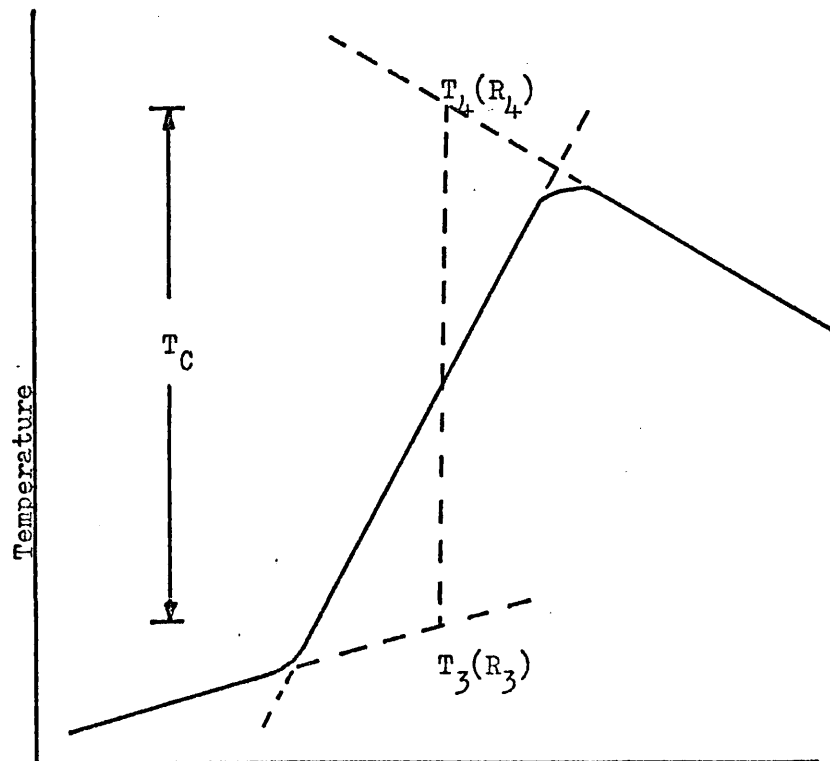

T_1 represents the temperature at the time of ampoule breaking and T_2 represents the corrected final temperature, thus $T_2 - T_1$ is the temperature change during the reaction. The resistance values at T_1 and T_2 are R_1 and R_2 . Similarly for the calibration graph $T_4 - T_3$ represents the corrected temperature rise during calibration and T_3 and T_4 correspond to the resistance values R_3 and R_4 .

Assuming the temperature-resistance relationship of thermistors is given by:

$$R = A \exp \frac{B}{T}$$

where R = resistance in ohms, T = absolute temperature and A and B = termistor constants. It can be shown that if R_1 and R_3 and approximately the same and $T_2 - T_1 = \Delta T_R$ and $T_3 - T_4 = T_C$ are approximately equal then:

$$\frac{\Delta T_R}{\Delta T_C} = \frac{\ln (R_1/R_2)}{\ln (R_3/R_4)} = \frac{\ln R_1 - \ln R_2}{\ln R_3 - \ln R_4}$$

It has been shown²⁰⁸ that this approximation is correct to within 0.1% if the initial and final resistance during reaction and calibration are within 40 ohms.

The validity of regarding as linear the fore-and after-periods of the reaction and calibration resistance-time profiles is documented^{207,209}. The reactions studied were all fast (complete in less than two minutes). Thus, the resistance values before and after the reactions, R_1 and R_2 , could be found by extrapolating the linear fore-and after-periods to the time of ampoule breaking. However, heating during the calibration period took about five minutes and allowance had to be made for the heat loss during

this time. This can be carried out by Dickinson's 'equal area' method.^{206,210,211} However, Anthony²⁰⁷ and Gunn²⁰⁹ have simplified this procedure due to the linear nature of the resistance-time profile during heating. They have shown that R_3 and R_4 may be obtained from the extrapolated for-and after-plots at the mid-point of the time t between the corrected initial and final resistance values. This concept is best illustrated in III - C.4.(b).

The equation used to determine the enthalpy change during the reaction is:

$$\Delta H_R = \frac{f \times P \times t}{4184} \times \frac{M}{w} \times \frac{\ln \frac{R_1/R_2}{R_3/R_4}}{\ln \frac{R_3/R_4}{R_3/R_4}} \text{ K.cal.mol.}^{-1}$$

where f = factor to account for heat dissipated in the heater leads

$$= R_g/R$$

where R_g = the resistance of the heater element

and R = resistance of heater element and leads

P = power of the heater

t = time of heating (secs)

M = molecular weight

w = weight used

The values of P and R can be calculated from measurements of the potentials V_1 and V_2 in the heater circuit shown in figure III - C.2.(b).

The performance of the calorimeter was periodically checked by studying the standard neutralisation reaction of tris (hydroxymethylaminomethane)(THAM) in excess N/10 hydrochloric acid:

$$(\text{CH}_2\text{OH})_3 \text{NH}_2 + (m+1)\text{HCl} \cdot n \text{H}_2\text{O} \longrightarrow ((\text{CH}_2\text{OH})_3 \text{NH}_3^+ + \text{Cl}^-) n\text{HCl} \cdot n\text{H}_2\text{O}$$

where m and n are the number of moles of HCl and water respectively.

The literature values for the enthalpy of reaction are shown in table III - C.1.

Table III - C.1.

Reference	Dilution, n	- ΔH	
		K.cal.mol ⁻¹	K.J.mol ⁻¹
Gunn ²¹²	373 - 1120	7.107 [±] 0.001	29.736 [±] 0.004
Sunner and Wadsö ²¹³	1138 - 1462	7.111 [±] 0.001	29.752 [±] 0.004
Ojelund and Wadsö ²¹⁴	1320 - 1390	7.112 [±] 0.002	29.757 [±] 0.008
Hill et.al. ²¹⁵	1170 - 1574	7.109 [±] 0.001	29.744 [±] 0.003

The THAM (B.D.H. Aristar grade, min 99.9%) results obtained throughout this investigation are contained in table III - C.2., from which is derived:

$$\text{Mean } \Delta H_R = -7.10 \pm 0.02 \text{ K.cal.mol}^{-1} \text{ (29.71 } \pm 0.08 \text{ K.J.mol}^{-1}\text{)}$$

Table III - C.2.

Enthalpy of Reaction of THAM with excess 0.1M HCl

	dilution,n	ΔH_R	
		K.cal.mol ⁻¹	K.J.mol ⁻¹
1	1279	7.07	29.58
2	1425	7.11	29.75
3	1372	7.08	29.62
4	1385	7.10	29.71
5	1398	7.12	29.79
6	1246	7.10	29.71
7	1441	7.08	29.62
8	1305	7.17	30.00
9	1327	7.08	29.62
10	1335	7.12	29.79
11	1321	7.08	29.62

(b) The heats of solution of iodic acid were obtained using and LKB 8700-1 Calorimetry System. This is a commercial instrument and detailed construction and operating procedures are given in the instruction manual. The reproducibility of the calorimeter is quoted to be as good as $\pm 0.01\%$ and the instrument accuracy under normal working conditions is better than 0.02% . The basic principle of this calorimeter is identical to that described in section (a) but certain experimental details differ. A block diagram of the calorimeter is shown in figure III - C.5.

The calorimeter cell consists of a thin-walled pyrex 100ml. vessel. The thermistor and heater are introduced by gold-plated feed-through pins in the lid. The stainless-steel stirrer spindle is attached to the gold ampoule, the whole arrangement being rotated during experiments. Ampoule breaking is achieved by means of a sapphire-tipped rod located in the base of the cell with the stirrer/ampoule holder mechanism moving vertically about 20mm.

The power of the heater used for the calibration could be selected from the approximate values of 20, 50, 100, 200 and 500 mW., the corresponding I^2 values being (0.4, 1, 2, 4 and 10) $\times 10^{-3} A^2$ respectively. The value selected was calculated to give the required temperature rise in a heating period of about 100 seconds.

A chart recorder (Bryans Ltd., model 2700 O) was used to monitor the out-of-balance bridge potential of the Wheatstone Bridge circuit incorporating the thermistor (figure III - C.6.(a)). It has been shown in this laboratory that in a series of experiments

FIGURE: III-C.5 BLOCK DIAGRAM OF LKB 8700 CALORIMETRY SYSTEM

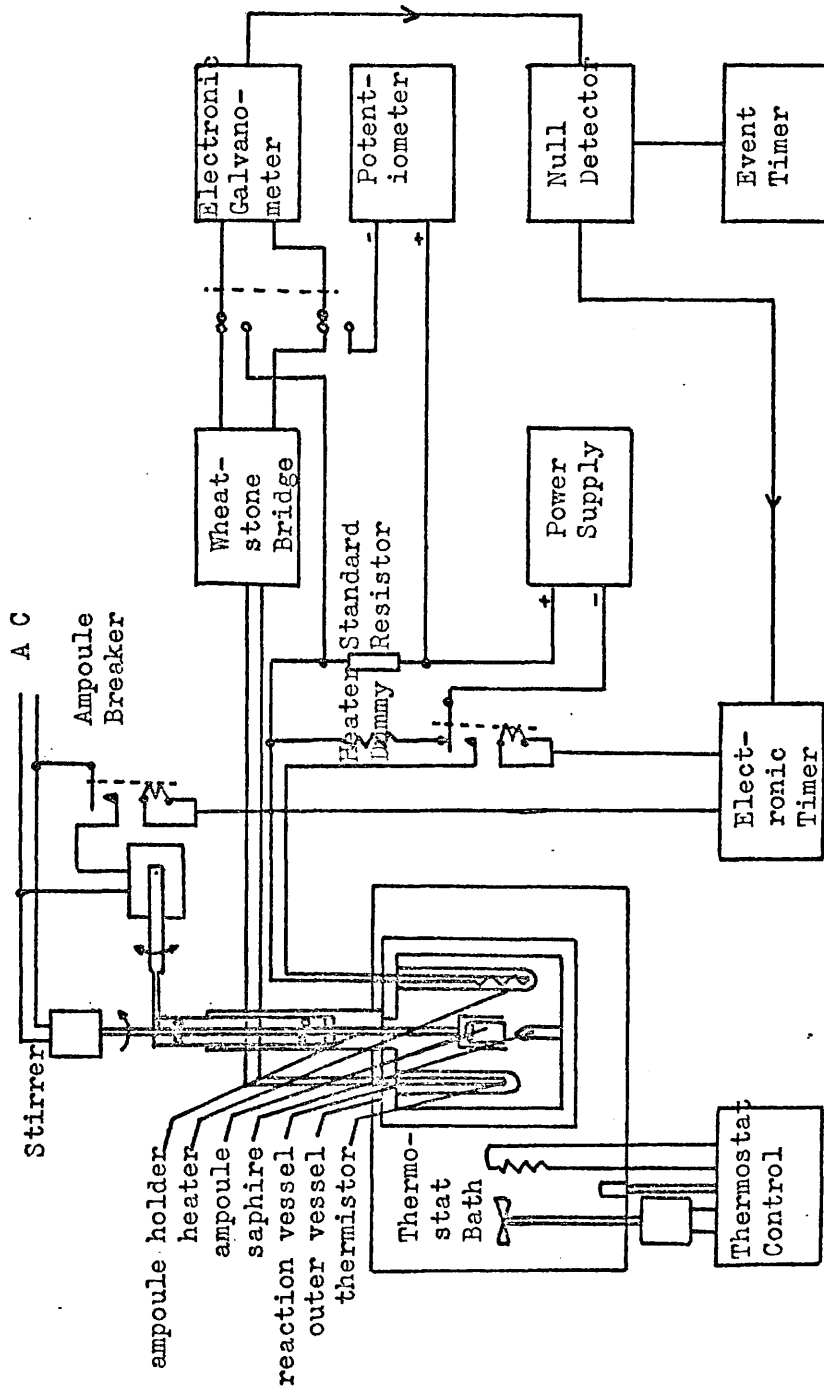

that THAM results obtained using first a chart recorder and then a galvanometer agree to well within the limits of any experimental error. The sensitivities on the null potentiometer and the chart recorder were adjusted such that $0.01\Omega \equiv 1\text{cm.}$ of chart paper.

It was noted for the previous calorimeter that for fast reactions R_2 was obtained by extrapolating the after-period back to the time of ampoule breaking. However, for the more precise LKB calorimeter the value of R_2 should be found by extrapolating the after-period back to the more correct time for a moderate reaction corresponding to 0.6 of the resistance change ($t_{0.6}$). However, using a chart recorder the exact position of $t_{0.6}$ cannot be found and so must be estimated. This estimation in R_2 probably places uncertainty of about $\pm 0.001\Omega$ to its value which is well within any experimental limits. In the calibration the time corresponding to half the resistance change, which is needed for the extrapolations, can be found using a chart recorder.

All the weights used in these measurements were corrected to vacuo. The procedure for this correction is outlined in Appendix III. In order to obtain more precise dilution values the 100ml. pipette used was calibrated by weighing the amount of water it delivered.

The enthalpy change associated with the reaction is given by the expression:

$$-\Delta H = \frac{P \times t}{4184} \times \frac{M}{w} \times \frac{\left(\frac{\Delta R}{R_m}\right)_{\text{reaction}}}{\left(\frac{\Delta R}{R_m}\right)_{\text{calib.}}} \text{ K.cal.mol}^{-1}$$

where $P = \text{power of heater} = R_h I^2$

$R_h = \text{corrected resistance of heater (corrected for resistance of the leads)}$

I = calibration current

M = molecular weight

w = weight used

t = time seconds

ΔR = resistance change = $R_{\text{initial}} - R_{\text{final}}$

and R_m = mean resistance = $R_{\text{initial}} - \frac{\Delta R}{2}$

The resistance of the heater can be found from the circuit in figure III - 6.(b). The current in the circuit is adjusted so that the potential drop across the standard 50Ω resistor is 1.00000 volt. The potential drop across the heater is then measured and the resistance calculated.

The performance of the calorimeter has been periodically checked by the endothermic enthalpy of solution of potassium chloride (B.D.H. Ltd., min 99.8%). A value of $\Delta H = +4.205 \text{ K.cal.mol}^{-1}$ at $n = 381$ (literature²¹² $\Delta H = 4.201 \pm 0.001$ at $n = 200$) was obtained.

FIGURE: III-C.6(a) THE LKB 8703 WHEATSTONE BRIDGE

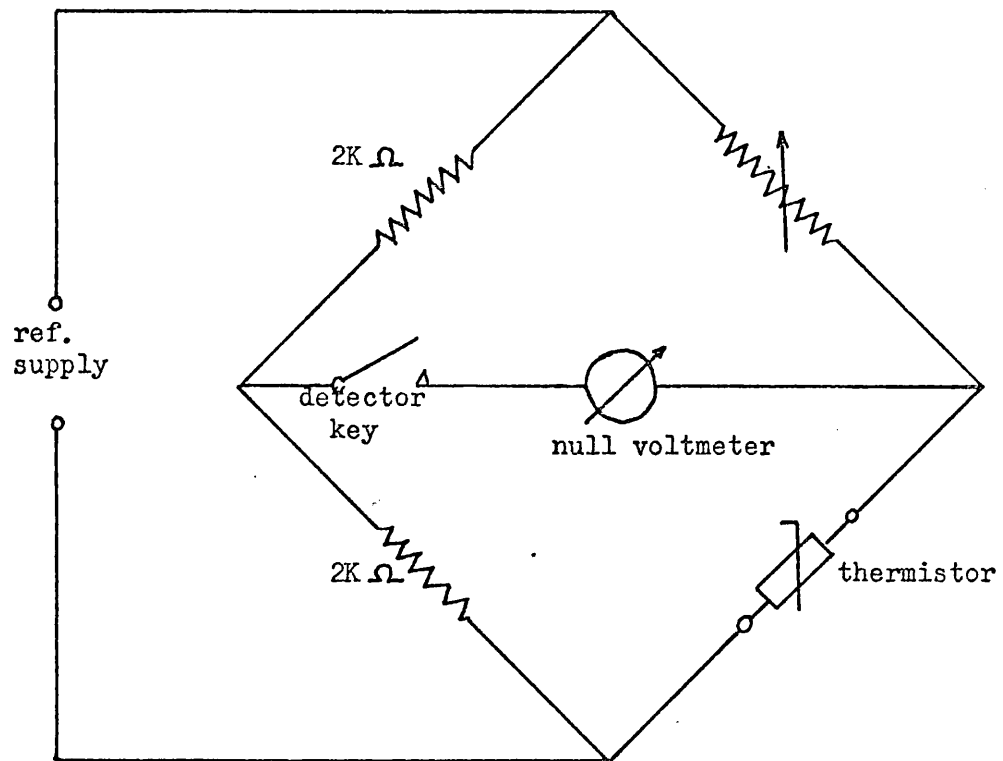
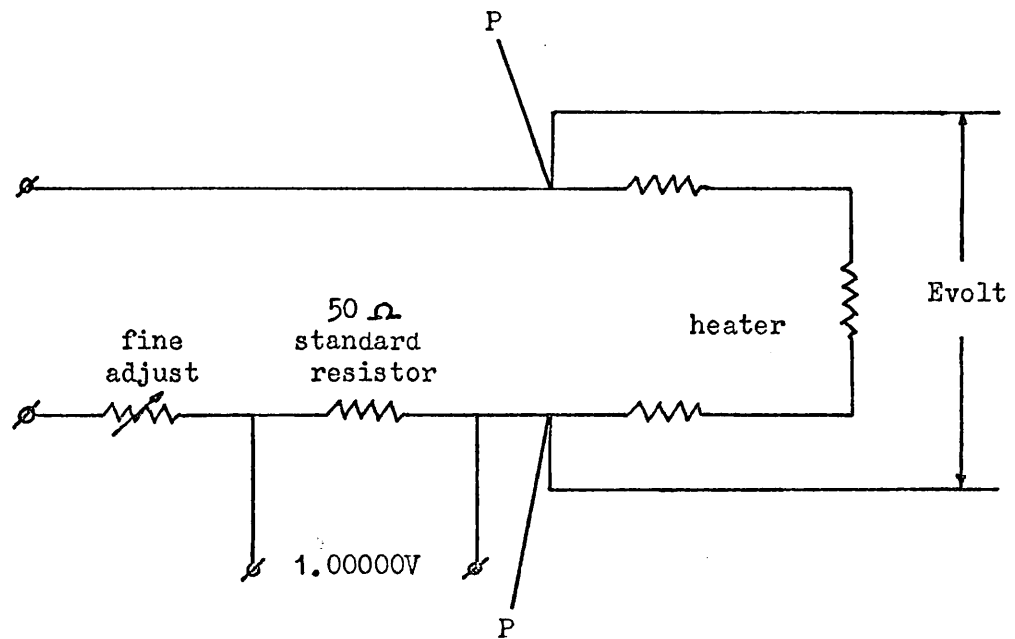

FIGURE: III-C.6(b) THE LKB 8701 HEATER CIRCUIT



P:potentiometer points

A P P E N D I X I

Lattice Energy

Lattice Energies and related topics have been reviewed comprehensively by Waddington,²¹⁶ and others.²¹⁷⁻²²⁰

The lattice energy of an ionic compound, U_0 , at 0°K may be defined as the internal energy change that takes place when one mole of the compound, at one atmosphere pressure, is converted into its gaseous ions at infinite separation. At 0°K these ions are stationary.

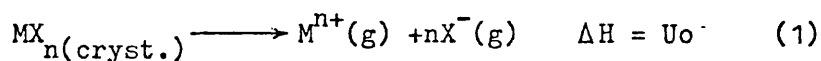

This energy arises predominantly from the coulombic attraction and interatomic repulsion terms; at temperatures above 0°K a further small quantity, $(n+1)RT$, must be added for the energy required to expand $(n+1)$ moles of gas to infinitely small pressure.

The lattice energy at 298°K , U_{298} , can be related to other thermodynamic quantities by the Born-Haber cycle, as shown below:

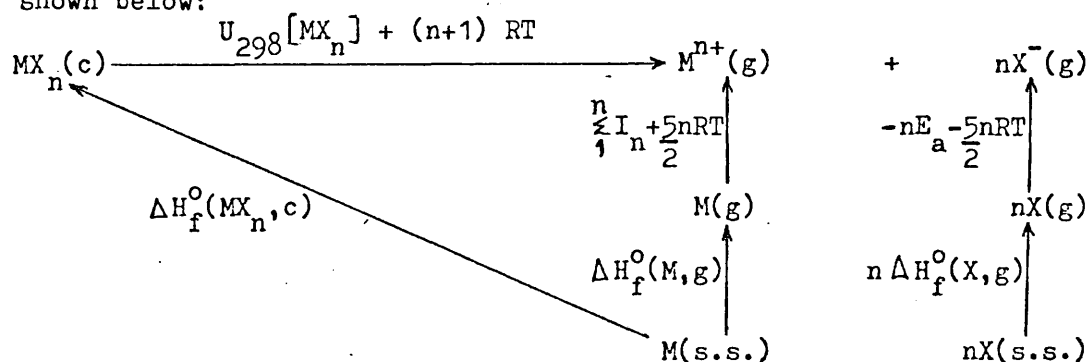

$\Delta H_f^\circ(\text{MX}_n, c)$, $\Delta H_f^\circ(\text{M}, g)$ and $\Delta H_f^\circ(\text{X}, g)$ are the enthalpies of formation of crystalline MX_n , gaseous M and gaseous X. $\sum_1^n I_n$ is the sum of the first n ionisation potentials of M and E_a is the electron affinity of the radical X; these values are corrected to 298°K by the addition of the $\frac{5}{2}nRT$ terms. No interactions need be considered between the ions $\text{M}^{n+}(g)$ and $\text{X}^-(g)$ as they are in the hypothetical ideal gas state.

From the above cycle:

$$U_{298}(\text{MX}_n) = \Delta H_f^\circ(\text{M}, g) + n \Delta H_f^\circ(\text{X}, g) + \sum_1^n I_n - nE_a - \Delta H_f^\circ(\text{MX}_n, c) - (n+1)RT \quad (2)$$

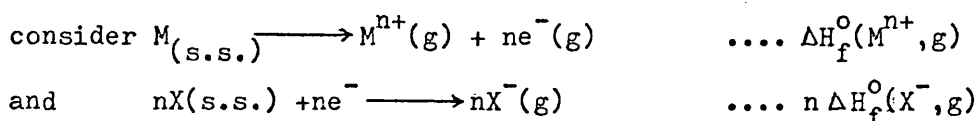

Equation (2) becomes:

$$U_{298}(\text{MX}_n) = \Delta H_f^\circ(\text{M}^+, g) + n \Delta H_f^\circ(\text{X}^-, g) - \Delta H_f^\circ(\text{MX}_n, c) - (n+1)RT \quad (3)$$

The lattice energy at 298°K is related to the lattice energy at 0°K by:

$$U_{298} = U_0 + \int_0^{298} [C_p^\circ(\text{M}^+) + nC_p^\circ(\text{X}^-) - C_p^\circ(\text{MX}_n)] \cdot dT - (n+1)RT \quad (4)$$

assuming the specific heats $C_p^\circ(\text{M}^+)$ and $C_p^\circ(\text{X}^-)$ are $\frac{5}{2}R$ for an ideal monatomic gas, then equation (4) becomes:

$$U_{298} = U_0 + \frac{3}{2}(n+1)RT - \int_0^{298} C_p^\circ(\text{MX}_n) \cdot dT \quad (5)$$

The integration can be performed if the specific heat-temperature function of the compound MX_n is known from 0°-298°K.

The use of the Born-Haber cycle in the calculation of lattice energies is restricted to these compounds for which the appropriate ionisation potentials and electron affinity data are available.

For ionic compounds with exactly known structural

parameters lattice energies can be obtained from extended classical calculations. These calculations involve the summing of attractive and repulsive interactions and have been discussed by Waddington.²¹⁶

Kapustinskii^{219,221} had developed a semi-empirical expression for the determination of lattice energies in cases where experimental data are lacking. He demonstrated that if the Madelung constants (the sum of the coulombic interaction terms characteristic of a crystal structure) for a number of structures were divided by V , the number of ions in one molecule, the values obtained were almost constant (Table I.1)

Table I.1.

Structure	Madelung Const., M	M/V	Average Co-ordination Number
Caesium chloride	1,763	0.88	8.0
Sodium chloride	1.748	0.87	6.0
Fluorite	2.519	0.84	5.33
Wurtzite	1.641	0.82	4.0
Rutile	2.408	0.80	4.0
Amastase	2.400	0.80	4.0
Cuprite	2.221	0.74	2.67

The equilibrium internuclear distance, r_0 , in an ionic compound generally increases slightly with co-ordination number; thus, making the variations of M/Vr_0 even less than M/V . Kapustinskii

now considers all salts to crystallise in a sodium chloride type lattice.

The classical Born-Mayer expression for calculating the lattice energy of a crystal is given by:

$$U_o = \frac{NMZ_1Z_2e^2}{r_o} \cdot \left[1 - \frac{\rho}{r_o} \right] \quad (6)$$

where N is the Avogadro number, M = Madelung constant, Z_1 and Z_2 are the cationic and anionic charges, e is the electronic charge, r_o is the equilibrium internuclear distance and ρ is a constant. Now, for the six-co-ordination sodium chloride lattice M/Vr_o is $0.874/r_o$ and ρ is almost constant at 0.345. Kapustinskii further assumes that the cation and anion 'touch' so that r_o may be replaced by $(r_c + r_a)$ where r_c and r_a are the cationic and anionic radii for six-co-ordination.

Thus, Kapustinskii's modified Born-Mayer equation becomes:

$$U_o = \frac{287.2 V Z_+ Z_-}{(r_c + r_a)} \cdot \left(1 - \frac{0.345}{(r_c + r_a)} \right) \quad (7)$$

It is generally found that lattice energies given by equation (7) are lower than those by extended calculations or Born-Haber cycles. Yatsimirskii¹⁹⁷, therefore, extended the Kapustinskii equation:

$$U_o = \frac{287.2 V Z_+ Z_-}{r_c + r_a} \left(1 - \frac{0.345}{r_c + r_a} \right) + 2.5 V Z_+ Z_-$$

This extension adds 5 K.cal.mol⁻¹ to the original lattice energy for a uni-univalent salt.

A difficulty when using the Kapustinskii equation is to assign a value to the ionic radius if a complex cation or anion is present. Yatsimirskii²²³ has proposed a method of overcoming this difficulty.

Consider the reaction:

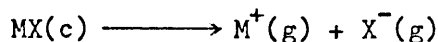

The enthalpy of reaction is given by $U_0 + 2RT$.

$$\therefore U_0 + 2RT = \Delta H_f^\circ \text{M}^+(g) + \Delta H_f^\circ \text{X}^-(g) - \Delta H_f^\circ \text{MX}(c) \quad (9)$$

Now, if two salts, M_1X and M_2X , have a common anion

$$U_1 + 2RT = \Delta H_f^\circ \text{M}_1^+(g) + \Delta H_f^\circ \text{X}^-(g) - \Delta H_f^\circ \text{M}_1\text{X}(c) \quad (10)$$

$$U_2 + 2RT = \Delta H_f^\circ \text{M}_2^+(g) + \Delta H_f^\circ \text{X}^-(g) - \Delta H_f^\circ \text{M}_2\text{X}(c) \quad (11)$$

$$(10)-(11) \quad U_1 - U_2 = \Delta H_f^\circ \text{M}_1^+(g) - \Delta H_f^\circ \text{M}_2^+(g) - \Delta H_f^\circ \text{M}_1\text{X}(c) + \Delta H_f^\circ \text{M}_2\text{X}(c) \quad (12)$$

From the Kapustinskii equation:

$$U_1 - U_2 = A \left[\frac{1}{(r_{\text{M}_1^+} + r_{\text{X}^-})} \left(1 - \frac{0.345}{(r_{\text{M}_1^+} + r_{\text{X}^-})} \right) - \frac{1}{(r_{\text{M}_2^+} + r_{\text{X}^-})} \left(1 - \frac{0.345}{(r_{\text{M}_2^+} + r_{\text{X}^-})} \right) \right] \quad (13)$$

Thus, if the enthalpies of formation of the gaseous ions and crystalline salts and the ionic radii of M_1^+ and M_2^+ are known then equations (12) and (13) may be equated and the quantity r_{X^-} calculated. Radii obtained from these calculations are known as 'thermochemical' radii. These radii can then be inserted into equation (8), from which the lattice energy of any salt containing that anion may be calculated, provided the ionic radius of the cation is known. Also, substitution of the lattice energy into equation (10) or (11) will give:

$$\Delta H_f^\circ [\text{X}^-g]$$

Therefore, although it is necessary to make several assumptions the Kapustinskii equation provides a useful guide to approximate lattice energies, especially when the structure is unknown.

A P P E N D I X I I

Errors

For observations between 4 and 12 the uncertainty interval is taken as twice the standard deviation of the mean (\bar{s}), as proposed by Rossini and Deming.²²⁴

$$\bar{s} = \pm \left[\frac{\sum (x - \bar{x})^2}{n(n-1)} \right]^{\frac{1}{2}}$$

where n is the number of observations of which the arithmetic mean is \bar{x} and x is an observation. The probability that a value lies within this range is 67%.

For a series of values e.g.

$$\Delta H = \Delta H_1 + \Delta H_2 \text{ ----- } \Delta H_n$$

where ΔH_i has an uncertainty interval of $\pm x_i$. Then the uncertainty interval for ΔH is taken as

$$\pm \left[\sum_{i=1}^n (x_i)^2 \right]^{\frac{1}{2}}$$

Certain ancillary data used in the thermochemical section (II - B) are taken from reference 198 (N.B.S. values). However, some of the data sources for these values are unlisted. Thus, the procedure followed in assigning an uncertainty interval is identical to that used in the 'CATCH' tables²²² i.e. the uncertainty interval is assumed to be ten times the last figure given.

A P P E N D I X I I I

Corrections

Correcting Weights to Vacuo²⁰⁴

For experiments where very accurate weighings are necessary a correction should be made for the effect of the buoyancy of the air. This correction involves reducing the weighings to vacuo.

The weight of an object in vacuo = weight in air + weight of air displaced by object - weight of air displaced by weight.

$$W_v = W_a + d_a \left(\frac{W_v}{d_b} - \frac{W_a}{d_w} \right)$$

where W_v = weight in vacuo, W_a = apparent weight in air,

d_a = density of air, d_w = density of weights, d_b = density of body.

The density of air is normally about 0.0012g/cm^3 . Since the difference in W_v and W_a does not normally exceed 1-2 parts per thousand.

$$W_v = W_a + d_a \left(\frac{W_a}{d_b} - \frac{W_a}{d_w} \right)$$

The density of stainless-steel is 8.0g/cm^3 .

$$W_v = W_a + W_a \left\{ 0.0012 \left(\frac{1}{d_b} - \frac{1}{8.0} \right) \right\}$$
$$= W_a + \frac{k(W_a)}{1000}$$

$$\text{where } k = 1.20 \left\{ \frac{1}{d_b} - \frac{1}{8.0} \right\}$$

The density of iodic acid is given²²⁶ as 4.629g/cm^3

Corrections for Vacuum-Filled Ampoules

Two corrections must be made when using vacuum-filled ampoules. The first accounts for the weight of air present in the empty unevacuated ampoule. The second concerns the enthalpy of vaporisation as a small proportion of the liquid will be in the vapour phase.

For weight of air:

$$\text{Correction to weight} = (\text{volume} \times 0.001189)\text{g.}$$

The average volume of the ampoules was found to be about 2.5cm^3 giving a 3 mg. difference for weight of air. A 3mg. difference in weight accounts for a difference of approximately $0.16 \text{ K.cal.mol}^{-1}$ in the ΔH_R of IF_5 , assuming a weight of 500mg. was used.

Correction for enthalpy of vaporisation:

$$\text{Correction of } \Delta H_R = \frac{\Delta H_{\text{vap.}} \times \text{vap.pressure} \times \text{ampoule volume} \times \text{mol.wt.}}$$

$$R \times T \times \text{weight used.}$$

$$R = 62.360 \times 10^3 \text{ ml. torr. K}^{-1} \text{ mol}^{-1}$$

$$\Delta H_{\text{vap.}} = 9.40 \text{ K.cal.mol}^{-1} \cdot 160$$

$$\text{vapour pressure at } 298^\circ\text{K} = 30\text{m.m. of Hg}^{160}$$

The correction to ΔH_R for 500 mg. of IF_5 is about $0.02 \text{ K.cal.mol}^{-1}$

REFERENCES

- 1 M.Schmeisser & K.Brändle 'Oxides & Oxyfluorides of the Halogens'. Adv.Inorg.Chem. & Radiochem. vol.5. ed. H.J.Emeléus & A.G. Sharpe Academic Press 1963.
- 2 R.F.Weinland & O.Lauenstein Z.Anorg.Allgem Chem.20,30(1899)
- 3 R.F.Weinland & O.Köppen. Z.Anorg.Allgem.Chem.22,256(1900)
- 4 L.Helmholtz & M.T.Rogers J.Am.Chem.Soc.62,1537 (1940)
- 5 P.C.van der Vorm & R.S.Drago J.Am.Chem.Soc.88,3255 (1966)
- 6 R.F.Hudson.Angew.Chem.,Int.Ed.Engl. 6,749 (1967)
- 7 R.J.Gillespie Angew.Chem.,Int.Ed.Engl.6,819 (1967)
- 8 H.A.Carter & F. Aubke Inorg.Chem.10(10)2296 (1971)
- 9 J.J.Pitts,S.Kongpricha & A.W.Jache Inorg.Chem.4,(2),257 (1965)
- 10 H.Klamm,H.Meinert,P.Reich & K.Witte Z.Chem.8(12)469 (1968)
- 11 A.Ray Ph.D. Dissertation. Univ. of Calcutta 1955
- 12 A.Ray & G. Mitra Science & Culture 21,379 (1956)
- 13 A.Ray & G.Mitra J.Indian Chem.Soc.37,781 (1960)
- 14 A.Ray & G.Mitra Science & Culture 19,216 (1953)
- 15 G.Mitra Z.Anorg.Allgem.Chem.,340,110 (1965)
- 16 G.Mitra Z.Anorg.Allgem.Chem.,368,336 (1969)
- 17 D.M.Gardner,E.J.Bartoszek,E.E.Hillman,C.J.Mackley & O.S.Sprout
Unpublished Results
- 18 D.K.Huggins & W.B.Fox Inorg.Nucl.Chem.Lett.6,337 (1970)
- 19 K.O.Christe & E.C.Curtis Inorg.Chem.11(1),35 (1972)
- 20 K.O.Christe,paper presented at the Fourth International Fluorine Symposium,Estes Park, Colo. July, 1967
- 21 J.L.Huston J.Phys.Chem. 71,3339 (1967)
- 22 H.H. Claassen, E.L.Gasner & H. Kim J.Chem.Phys.49(1)253 (1968)
- 23 E.L.Gasner & H.H.Claassen Inorg.Chem.6,1937 (1967)

- 24 O.Ruff & A.Braida *Angew.Chem.*47,480 (1934)
- 25 E.E.Aynsley,R.Nichols & P.L.Robinson *J.Chem.Soc.*623 (1953)
- 26 E.E.Aynsley & M.L.Hair *J.Chem.Soc.* 3747 (1958)
- 27 E.E.Aynsley *J.Chem.Soc.* 2425 (1958)
- 28 H.J.Emeléus & A.G.Sharpe *J.Chem.Soc.*2206 (1949)
- 29 J.W.Viers & H.W.Baird *Chem.Comm.* 1093 (1967)
- 30 J.W.Viers & H.W. Baird Unpublished Results
- 31 D.F.Smith & G.M.Begun *J.Chem.Phys.* 43,2001 (1965)
- 32 R.Bougon,J.Isabey & P.Plurien.*C.R.Acad.Sci.Ser.C.*1970 271(22)1366
- 33 R.J.Gillespie,B.Landa & G.J.Schrobilgen.*Chem.Comm.*607 (1972)
- 34 R.J.Gillespie & G.J.Schrobilgen unpublished work
- 35 M.Schmeisser & K.Lang *Angew.Chem.*67,156 (1955)
- 36 P.W.Schenk & D.Gerlatzek *Z.Chem.*10,153 (1970)
- 37 D.F.Smith,G.M.Begun & W.H.Fletcher,*Spectrochim.Acta.*20,1763 (1964)
- 38 E.E.Aynsley & S.Sampath *J.Chem.Soc.* 3099 (1959)
- 39 F.Aubke,G.H.Cady & C.H.L.Kennard *Inorg.Chem.*3,1799 (1964)
- 40 F.B.Dudley & G.H.Cady *J.Am.Chem.Soc.*79,513 (1957)
- 41 J.E.Roberts & G.H.Cady *J.Am.Chem.Soc.*82,353 (1960)
- 42 J.M.Shrewe & G.H.Cady *J.Am.Chem.Soc.*83,4521 (1961)
- 43 A.J.Edwards & G.R.Jones *J.Chem.Soc.A.* 2858 (1969)
- 44 P.A.Yeats,B.F.E.Ford,J.R.Sams & F.Aubke *Chem.Comm.*791 (1969)
- 45 P.A.Yeats,B.L.Poh,B.F.E.Ford & F.Aubke *J.Chem.Soc.A.*2188 (1970)
- 46 F,H,Allen,J.Lerbscher & J.Trotter *J.Chem.Soc.A.*2507 (1971)
- 47 M.Schmeisser & E.Pammer *Angew.Chem.*69,781 (1957)
- 48 M.Schmeisser & E.Pammer *Angew.Chem.*67,156 (1955)
- 49 E.N.Sloth,L.Stein & C.W.Williams *J.Phys.Chem.*73,278 (1969)
- 50 H.Bode & E.Klesper *Angew.Chem.*66,605 (1954)
- 51 A.Engelbrecht *Angew.Chem.*66,442 (1954)

- 52 A.Engelbrecht & H.Atzwanger J.Inorg.Nucl.Chem.2,348 (1956)
- 53 J.E.Sicre & H.J.Schumacher Angew.Chem.69,226 (1957)
- 54 A.A.Woolf J.Chem.Soc. 4113 (1954)
- 55 W.Fink Dissertation Univ. of Munich 1956
- 56 H.Scnitz & H.J.Schumacher Z.Anorg.Allgem.Chem.249,238 (1942)
- 57 J.E.Sicre & H.J.Schumacher Z.Anorg.Allgem.Chem.286,232 (1956)
- 58 M.Schmeisser & W.Fink Angew.Chem.69,780 (1957)
- 59 A.J.Arvia,W.H.Basualdo & H.J.Schumacher Angew.Chem.67,616 (1955)
- 60 A.J.Arvia,P.J.Aymonino & H.J.Schumacher Z.Anorg.Allgem.Chem.
286,58 (1956)
- 61 A.Engelbrecht U.S. Patent 2,942,947 (June 28 1960)
- 62 H.Schmitz & H.J.Schumacher Z.Anorg.Allgem.Chem.249,238 (1942)
- 63 E.A.Smith,F.C.Steinbach & K.E.Ben.U.S.Atomic Energy Commission
GAT-T-687 (1959)
- 64 A.J.Arvia & P.J.Aymonino Spectrochim.Acta 19,1449 (1963)
- 65 M.Schmeisser & F.L.Ebenhöch Angew.Chem.66,230 (1954)
- 66 A.A.Woolf J.Chem.Soc. 4113 (1954)
- 67 H.A.Lehmann & G.Krueger Z.Anorg.Allgem.Chem.274,141 (1953)
- 68 K.O.Christe,C.J.Schack,D.Pilipavich & W.Sawodny Inorg.Chem.
8, (11)2489 (1969)
- 69 H.A.Carter,W.M.Johnson & F.Aubke Can.J.Chem.47,4619 (1969)
- 70 R.C.Paul,K.K.Paul & K.C.Malhotra Ind.J.Chem.8,1030 (1970)
- 71 R.C.Paul,K.K.Paul & K.C.Malhotra J.Inorg.Nucl.Chem.31,2614 (1969)
- 72 E.H.Appelman & M.H.Studier J.Am.Chem.Soc.91,4561 (1969)
- 73 E.H.Appelman Inorg.Chem.8,223 (1969)
- 74 H.H.Claassen & E.H.Appelman Inorg.Chem.9,622 (1970)
- 75 G.K.Johnson,P.A.G.O'Hare & E.H.Appelman Inorg.Chem.11,800 (1972)
- 76 H.Bode & E.Klesper Z.Anorg.Allgem.Chem.266,275 (1951)
- 77 G.Barth-Wehrenalp J.Inorg.Nucl.Chem.2,266 (1956)

- 78 W.A.LaLande Jr. Chem.Zentr.9880 (1958)
- 79 K.Lang Diplomarbeit, Univ. of Munich 1955
- 80 R.V.Figini,E.Colloccia & H.J.Schumacher Z.Physix.Chem.14,32 (1958)
- 81 H.C.Mandell Jr. & G.Barth-Wehrenalp J.Inorg.Nucl.Chem.12,90 (1959)
- 82 D.R.Lide Jr. & D.E.Mann J.Chem.Phys.25,1128 (1956)
- 83 R.P.Madden & W.S.Benedict J.Chem.Phys.25,594 (1956)
- 84 P.X.Powell & E.R.Lippencott J.Phys.Chem.32,1883 (1960)
- 85 D.R.Lide Jr. & D.E.Mann J.Chem.Phys.25,595 (1956)
- 86 A.H.Clark,B.Beagley,D.W.J.Cruickshank & T.G.Hewitt J.Chem.Soc.A
872 (1970)
- 87 C.A.Neltgebauer & J.L.Margrave J.Am.Chem.Soc.79,1338 (1957)
- 88 J.D.Cox Halogen Compounds CATCH Tables,Univ.of Sussex.
- 89 R.L.Jarry J.Phys.Chem.61,498 (1957)
- 90 J.K.Kochler & W.F.Gianque J.Am.Chem.Soc.80,2659 (1958)
- 91 A.Engelbrecht & P.Peterfy Angew.Chem.internat.Edit.8,769 (1969)
- 92 H.H.Willard Inorg.Syntheses 1,171 (1939)
- 93 R.J.Gillespie & J.W.Quail Proc.Chem.Soc.278 (1963)
- 94 L.G.Alexakos,C.D.Cornwall & S.B.Pierce Proc.Chem.Soc.341 (1963)
- 95 N.Bartlett & L.E.Levchuk Proc.Chem.Soc.342 (1963)
- 96 N.Bartlett,S.Beaton,L.W.Reeves & E.J.Wells Can.J.Chem.42,2531 (1964)
- 97 S.B.Pierce & C.D.Cornwall J.Chem.Phys.47,1731 (1967)
- 98 H.S.Booth & J.T.Pinkston Jr. Chem.Rev.41,421 (1947)
- 99 H.S.Booth & J.T.Pinkston Jr.'Fluorine Chemistry'ed.J.H.Simons
vol.1 p.189 Academic Press (1950)
- 100 H.J.Emeléus Bull.Soc.Chim.Fr.909 1953
- 101 H.J.Emeléus Fortschr.Chem.Forsch.2,609 (1953)
- 102 H.J.Emeléus 'Fluorine Chemistry'ed.J.H.Simons vol.II p.39
Academic Press (1954)
- 103 A.G.Sharpe Quart.Rev.4 115 (1950)

- 104 A.G.Sharpe 'Non-Aqueous Solvent Systems' ed.T.C.Waddington
p.285 Academic Press (1965)
- 105 N.N.Greenwood Rev.Pure Appl.Chem.1,84 (1951)
- 106 R.C.Brasted 'Comprehensive Inorganic Chemistry'ed.M.C.Sneed,
J.L.Maynard & R.C.Brasted vd.III p.179 Van Nostrand (1954)
- 107 Y.A.Fialkov Izv.Akad.Nauk.SSSR,Od.Khim.Nauk.972 (1954)
- 108 H.C.Clark Chem.Rev.58,869 (1958)
- 109 W.K.R.Musgrave 'Advances in Fluorine Chemistry'ed.M.Stacey,
J.C.Tatlow & A.G.Sharpe Vol.I,p.1 Academic Press (1960)
- 110 L.Stein 'Halogen Chemistry'ed.V.Gutmann Vol.Ip.133 Academic Press(1967)
- 111 I.G.Ryss'The Chemistry of Fluorine and its Inorganic Compounds'
AEC-tr-3927,Part 1,p.132,State Publishing House for
Scientific,Technical & Chemical Literature,Moscow (1956)
- 112 H.R.Leech 'Mellor's Comprehensive Treatise on Inorganic and
Theoretical Chemistry'Supplement II,Part I p.147 Longmans (1956)
- 113 R.D.W.Kemomitt & D.W.A.Sharp Adv.in Fluorine Chemistry,ed.M.Stacey
J.C.Tatlow & A.G.Sharpe Vol.4 p.142 Butterworths (1965)
- 114 J.H.Simons 'Fluorine Chemistry'ed.J.H.Simons Vol.5 p.78
Academic Press (1964)
- 115 R.F.Barrow 'Mellor's Comprehensive Treatise on Inorganic &
Theoretical Chemistry'Supplement II part Ipp.224,632,787
Longmans (1956)
- 116 R.J.Gillespie & M.J.Morton Quat.Revs.25,553 (1971)
- 117 JANAF Thermochemical Tables,The Dow Chemical Co.,Midland,
Michigan, Dec.31,1960 to Dec.31, 1963.
- 118 R.A.Durie Proc.phys.Soc.63A 1292 (1950)
- 119 R.A.Durie Proc.Roy.Soc.A207 388 (1951)
- 120 W.H.Evans,T.R.Maunson & D.D.Wagman J.Res.nat.Bur.Stand.55,147
- 121 R.A. Durie Can.J.Phys.44,337 (1966)
- 122 M.Schmeisser & E.Scharf Angew.Chem.72,324 (1960)

- 123 M.Schmeisser, P.Sartori & D.Naumann. Chem. Ber. 103, 590 (1970)
- 124 A.P.Irsa & L.Friedman. J. Inorg. Nucl. Chem. 6, 77 (1958)
- 125 H.Meinert & H.Klamm Z. Chem. 5, 468 (1965)
- 126 M.Schmeisser, W.Ludovici, D.Naumann, P.Sartori & E.Sharf Chem.
Ber., 101, 4214 (1968)
- 127 M.Schmeisser & W.Ludovici Z. Naturf. 206 602 (1965)
- 128 M.Schmeisser, P.Sartori & D.Naumann Chem. Ber. 103, 880 (1970)
- 129 G.B.Hargreaves & R.D.Peacock J. Chem. Soc. 2373 (1960)
- 130 L.B.Asprey, J.L.Margrave & M.E.Silverthorn J. Am. Chem. Soc. 83 2955 (1961)
- 131 H.Bode & E.Klesper Z. Anorg. Allgem. Chem. 313, 161, (1961)
- 132 J.Shamin & I.Yaroslavsky Israel J. Chem. 7, 495 (1969)
- 133 K.O.Christe & W.Sawodny Z. Anorg. Allgem. Chem. 357, 125 (1968)
- 134 K.O.Christe Inorg. Chem. 11, 1215 (1972)
- 135 H.Moissan Ann. Chim. Phys. 24, 224 (1891)
- 136 H.Moissan Comp. rend. 135, 563 (1901)
- 137 E.B.R.Prideaux Trans. Chem. Soc. 316 (1906)
- 138 O.Ruff & R. Zeim Z. Anorg. Allgem. Chem. 193, 176 (1930)
- 139 O.Ruff & R.Zeim Z. Anorg. Allgem. Chem. 201, 245 (1931)
- 140 M.T.Rogers, J.L.Spiers, H.B.Thompson & M.B.Panish J. Am. Chem. Soc. 76, 4843
(1954)
- 141 M.T.Rogers, J.L.Spiers, M.B.Panish & H.B.Thompson J. Am. Chem. Soc.
78, 936 (1956)
- 142 A.A.Woolf J. Chem. Soc. 3678 (1950)
- 143 R.C.Lord, M.A.Lynch Jr., W.C.Schumb & E.J.Slowinski Jr. J. Am. Chem.
Soc. 72, 522 (1950)
- 144 G.M.Begun, W.H.Fletcher & D.F.Smith J. Chem. Phys. 42, 2236 (1965)
- 145 R.J.Gillespie & H.J.Clase J. Chem. Phys. 47, 1071 (1967)
- 146 H.Selig & H.Holzman Israel J. Chem. 7, 417 (1969)
- 147 L.E.Alexander & I.R.Beattie J. Chem. Soc. A. 3091 (1971)

- 148 H.S. Gutowsky & C.J.Hoffman J.Chem.Phys.19, 1259 (1951)
- 149 H.S. Gutowsky, D.W.McCall & C.P.Slichter J.Chem.Phys.21, 279 (1953)
- 150 E.L.Meutterties & W.D.Phillips J.Am.Chem.Soc.79, 322 (1957)
- 151 M.J.Whittle, R.H.Bradley & P.N.Brier Trans Faraday Soc.67, 2505 (1971)
- 152 R.H.Bradley, P.N.Brier & M.J.Whittle Chem.Phys.Letters 11, 192 (1971)
- 153 A.G.Robiette, R.H.Bradley & P.N.Brier Chem.Commun.1567 (1971)
- 154 H.Braune & P.Pinnow Z.Phys.Chem. 35B 239 (1937)
- 155 M.T.Rogers, A.L.Wahrhaftig & V.Schomaker Abstr.of Papers, 111th Meeting Am.Chem.Soc., Atlantic City, N.J. p.21P
- 156 E.L.Meutterties & W.D.Phillips J.Am.Chem.Soc.81, 1084 (1959)
- 157 N.Bartlett, S.Beaton, L.W.Reeves & E.J.Wells Can.J.Chem.42, 2531 (1964)
- 158 A.A. Woolf J.Chem.Soc. 231 (1951)
- 159 J.E.Settle, P.A.G.O'Hare, W.N.Hubbard & J.H.E.Jeffes (unpublished see ref.160)
- 160 D.W.Osborne, F.Schreiner & H. Selig J.Chem.Phys.54, 3790 (1971)
- 161 A.A. Woolf & N.N.Greenwood J.Chem.Soc.2200 (1950)
- 162 N.Bartlett & D.H. Lohman J.Chem.Soc. 5253 (1962)
- 163 N.Bartlett & D.H.Lohman J.Chem.Soc. 619 (1964)
- 164 H.W.Baird & H.F.Giles Acta Cryst.A25, S115 (1969)
- 165 E.L.Meutterties 'Adv.in the Chemistry of Co-ordination Compounds' ed.by S.Kirschner p.509 Macmillan
- 166 H.Meinert & H.Klamm Z.Chem.8, 195 (1968)
- 167 K.O.Christe, J.P.Guertin & W.Sawodny Inorg.Chem.7, 626 (1968)
- 168 H.Klamm, H.Meinert, P.Reich & K.Witke Z.Chem.8, 469 (1968)
- 169 H.Klamm, H.Meinert, P.Reich & K.Witke Z.Chem.8, 393 (1968)
- 170 S.P.Beaton, D.W.A.Sharp, A.J.Perkins, I.Sheft, H.H.Hyman, & K.O.Christe Inorg.Chem.7, 2174 (1968)
- 171 S.Bukshpan, J.Soriano & J.Shamir Chem.Phys.Lett.4, 241 (1969)
- 172 W.C.Schumb & M.A.Lynch Ind.Eng.Chem.42, 1383 (1950)

- 173 J.G.Malm & H.Selig J.Inorg.Nucl.Chem.,20, 189 (1961)
- 174 J.G.Malm, H.Selig & S.Fried J.Am.Chem.Soc.,82, 1510 (1960)
- 175 O.Glemser, H.W.Roesky, K.H.Helliberg & H.U.Werther Chem.Ber.,99, 2652
(1966)
- 176 H.H.Claassen, E.L.Gasner & H.Selig J.Chem.Phys.,49, 1803 (1968)
- 177 M.Brownstein & H.Selig Inorg.Chem.,11, 656 (1972)
- 178 S.H.Bauer J.Phys.Chem.,56, 343 (1952)
- 179 R.E.LaVilla & S.H.Bauer J.Chem.Phys.,33, 182 (1960)
- 180 H.B.Thompson Jr. & L.S.Bartell Trans Am.Crystal Assoc.,2, 190 (1966)
- 181 R.B.Bernstein & J.J.Katz J.Phys.Chem.,56, 885 (1952)
- 182 F.Seel & O.Detmer Angew Chem.,70, 163 (1958)
- 183 F.Seel & O.Detmer Z.Anorg.Allgem.Chem.,301, 113 (1959)
- 184 K.O.Christe & W.Sawodny Inorg.Chem.,6, 1783 (1967)
- 185 J.L.Hardwick & G.E.Leroi Inorg.Chem., 7, 1683 (1968)
- 186 K.O.Christe & W.Sawodny Inorg.Chem., 7, 1685 (1968)
- 187 K.O.Christe Inorg.Chem., 9, 2801 (1970)
- 188 J.F.Hon & K.O.Christe J.Chem.Phys., 52, 1960 (1970)
- 189 M.R.Barr & B.A. Dunell Can.J.Chem., 48, 895 (1970)
- 190 W.E.Dasent & T.C.Waddington J.Chem.Soc. 2429 (1960)
- 191 J.R. Durig, O.D.Bonner & W.H.Breazeale J.Phys.Chem.,69, 3886 (1965)
- 192 H.Siebert Z.Anorg.Allgem Chem., 273, 21 (1953)
- 193 K.Ramaswamy & P.Muthusubramanian J.Mol.Str.,6, 205 (1970)
- 194 K.Venkateswarlu & K.V. Rajalakshmi Indian J.Pure Appl.Phys.,1, 380 (1963)
- 195 K.Radhakrishnan Z Physik.Chem., 41, 201 (1964)
- 196 T.C.Waddington & W.E.Dasent J.Chem.Soc. 3350 (1960)
- 197 CODATA Key Values J.Chem.Therm., 3, 1 (1971)
- 198 F.D.Rossini, D.D.Wagman, W.H.Evans, S.Levine & I.Jaffe Selected Values
of Chemical Thermodynamic Properties, Nat.Bur.Standards Circ.500
(1952)
- 199 G.Pilcher Nitrogen Compounds CATCH Tables Univ. of Sussex.

- 200 M.A.Haney & J.F.Franklin J.Chem.Phys. 50, 2028 (1969)
- 201 D.A.Johnson 'Some Thermodynamic Aspects of Inorganic Chemistry'
Cambridge Univ. Press (1968)
- 202 Argonne Reports (1972)
- 203 W.L.Wheeler & S.L.Penfold Amer.J.Sci. 44, 123 (1892)
- 204 A.I.Vogel 'Quantitative Inorganic Analysis' p.376,154 Third
Edition Longmans (1968)
- 205 P.J.Gardner Ph.D Thesis, Univ.of London (1963)
- 206 R.J.Coley Ph.D Thesis, Univ. of London (1971)
- 207 M.E.Anthoney Ph.D Thesis, Univ. of London (1972)
- 208 G.R.Wellum Ph.D Thesis, Univ. of London (1969)
- 209 S.R.Gunn J. Chem.Therm. 3, 19 (1971)
- 210 A.Weissberger 'Techniques in Organic Chemistry' p.538
Interscience (1959)
- 211 H.C.Dickinson Nat.Bur.Standards Bull.11, 189 (1915)
- 212 S.R.Gunn, J.Phys.Chem. 69, 2902 (1965)
- 213 S.Sunner & I.Wadsö Science Tools 13, 1 (1966)
- 214 G.Ojelund & I.Wadsö Acta.Chem.Scand. 21, 1838 (1967)
- 215 J.O.Hill, G.Ojelund & I.Wadsö J.Chem.Therm. 1, 111 (1969)
- 216 T.C.Waddington 'Adv. in Inorg. Chem. and Radiochem' ed.H.J.E. Iéús
& A.G.Sharp, Vol.I. p.157 Academic Press (1959)
- 217 M.F.C.Ladd & W.H.Lee 'Prog.in Solid State Chem' ed.H.Reiss Vol.I,
p.37 Pergamon Press (1964)
- 218 M.F.C.Ladd & W.H.Lee 'Prog.in Solid State Chem' ed.H.Reiss Vol.II
p.378 Pergamon Press (1965)
- 219 A.F.Kapustinskii Quat.Tev. 10, 283 (1956)
- 220 N.N.Greenwood 'Ionic Crystals Lattice Defects & Nonstoichiometry'
Cpt. 3. Butterworths (1968)
- 221 A.F.Kupustinskii Z.Phys.Chem. 22B, 257 (1933)
- 222 Y.B.Yatsimirskii Russ.J.Inorg.Chem. 69, 385 (1961)

- 223 Y.B.Yatsimirskii Izvest.Akad.Nauk.S.S.S.R.,Otdel.Khim.Nauk,
453 (1947)
- 224 F.D.Rossini & W.E.Deming J.Wash.Acad.Sci. 29, 416 (1939)
- 225 Introduction of 'CATCH' Tables J.B.Pedley Univ.of Sussex (1972)
- 226 'Handbook of Chemistry and Physics' 51st edition ed.R.C.Weast.
The Chemical Rubber Co. (1971)

Short Communication

Thermodynamic and spectroscopic properties of the fluoroiodate ion

ARTHUR FINCH, P. N. GATES AND M. A. JENKINSON

Department of Chemistry, Royal Holloway College (University of London), Englefield Green, Surrey (Great Britain)

(Received February 26, 1972)

Oxy-fluorine anions are extremely rare, the only example of any oxy-fluorine iodine anion being that afforded by the fluoroiodate system, $[\text{IO}_2\text{F}_2]^-$. This ion is hence apparently unique, and whilst X-ray structural data are well-established¹, and the syntheses^{2,3} of several alkali metal and other salts are well known, no thermodynamic data exist. In this Communication we report preliminary measurements for the standard heats of formation of potassium and sodium fluoroiodates and also an estimation of the lattice energies of these crystals.

Potassium and sodium fluoroiodates were made by the established method of crystallisation from a 40% aqueous HF solution of the appropriate iodate. The crystals were gently dried and stored with rigorous exclusion of water. Fluorine and iodine analyses were as follows: Found: (i) I, 57.7; F, 17.3%. NaIO_2F_2 requires I, 57.7; F, 17.3%. Found: (ii) I, 53.8; F, 16.0%. KIO_2F_2 requires I, 53.8; F, 16.1%. Infrared and Raman frequencies for the potassium salt are listed in Table 1 together with assignments to fundamental modes. The observed spectra are substantially in agreement with those recently reported for KIO_2F_2 ⁴. The pattern of frequencies is entirely consistent with a C_{2v} formulation as required by the X-ray data. The pattern of the spectra for the Na^+ and K^+ compounds are very similar and it is thus reasonable to infer a common shape for the IO_2F_2^- ion in both of these compounds.

Calorimetric measurements were performed using aqueous alkaline hydrolysis in a solution-reaction calorimeter⁵ operated at 25° in the isoperibol mode. Reactions were rapid, being typically completed within *ca.* 2 min. The reaction enthalpy $\Delta H_{\text{obs}}^\circ$ refers to the reaction:

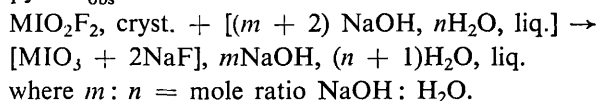

Hence

$$\begin{aligned} \Delta H_f^\circ[\text{MIO}_2\text{F}_2, \text{cryst.}] = & \Delta H_f^\circ[\text{MIO}_3, 5000\text{H}_2\text{O}] + 2\Delta H_f^\circ[\text{NaF}, 5000\text{H}_2\text{O}] \\ & + \Delta H_f^\circ[\text{H}_2\text{O}, \text{liq.}] - 2\Delta H_f^\circ[\text{NaOH}, 500\text{H}_2\text{O}] - \Delta H_{\text{obs}}^\circ \end{aligned}$$

In all runs, reaction was carried out at $25.0 \pm 0.01^\circ$ with the mole ratio $\text{NaOH} : \text{H}_2\text{O} = 1 : 555$.

Values for $\Delta H_{\text{obs}}^\circ$ for NaIO_2F_2 and KIO_2F_2 were -25.31 ± 0.11 and

TABLE 1
INFRARED AND RAMAN SPECTRA OF KIO_2F_2 IN THE SOLID STATE

Raman (cm^{-1})	Infrared (cm^{-1})	Assignments
194 (vw)	197 (s)	ν_4 (a_1)
—	220 (m, sh)	ν_5 (a_2)
323 (s)	—	ν_9 (b_2)
346 (w)	345 (s)	ν_7 (b_1)
	351 (w, sh)	
360 (m)	360 (s)	ν_3 (a_1)
	407 (m)	
456 (vw)	440 (m)	ν_8 (b_2)
479 (s)	485 (vs)	ν_2 (a_1)
804 (w, sh)	805 (w, sh)	
817 (vs)	819 (vs)	ν_1 (a_1)
838 (w)	845 (m)	
—	851 (m)	ν_6 (b_1)

s, strong; m, medium; w, weak; v, very; sh, shoulder.

-21.34 ± 0.17 kcal mol $^{-1}$, respectively. Hence, using accepted values for ancillary data⁶ we derive: $\Delta H_f^\circ[\text{NaIO}_2\text{F}_2, \text{cryst.}]_{298} = -202.85 \pm 0.23$ kcal mol $^{-1}$; $\Delta H_f^\circ[\text{KIO}_2\text{F}_2, \text{cryst.}]_{298} = -209.52 \pm 0.27$ kcal mol $^{-1}$. The thermodynamic stability of these compounds is further reflected in the magnitude of their lattice energies, U_{298} . These may be estimated from the Kapustinskii equation⁷, using either a circumcising radius derived from known structural parameters or by the thermochemical radius approach⁸. Values are as follows: NaIO_2F_2 , $U_{298} = 184$ kcal mol $^{-1}$; KIO_2F_2 , $U_{298} = 167$ kcal mol $^{-1}$. It is probably not meaningful to give definite error limits for the lattice energy values, but it is certainly reasonable to assume that the above values are correct to within 10 kcal mol $^{-1}$. Since the value of the thermochemical radius used is a major uncertainty, and is common, then *differences* in lattice energies do not reflect the above large uncertainty.

From the above values of the standard heats of formation and of the derived estimations of lattice energies, similar parameters for other alkali metal fluoroiodates and Group II fluoroiodates may be estimated by simple extrapolation.

We thank the Science Research Council for a maintenance grant (to M.A.J.).

REFERENCES

- 1 L. HELMHOLTZ AND M. T. ROGERS, *J. Amer. Chem. Soc.*, **62** (1940) 1537.
- 2 R. F. WEINLAND AND O. LAUENSTEIN, *Z. Anorg. Allgem. Chem.*, **20** (1899) 30.
- 3 R. F. WEINLAND AND O. KÖPPEN, *Z. Anorg. Allgem. Chem.*, **22** (1900) 256.
- 4 H. A. CARTER AND F. AUBKE, *Inorg. Chem.*, **10** (1971) 2296.
- 5 R. L. COLEY, *Ph. D. Thesis*, University of London, 1971.
- 6 F. M. ROSSINI, D. D. WAGMAN, W. H. EVANS, S. LEVINE AND I. JAFFE, *Nat. Bur. Standards Circular 500*, (1952).
- 7 A. F. KAPUSTINSKII, *Quart. Rev. (London)*, **10** (1956) 283.
- 8 K. B. YATSIMIRSKII, *Russ. J. Inorg. Chem.*, **6** (1961) 265.

J. Fluorine Chem., **2** (1972/73)

Thermochemistry of Fluorine Compounds. Part I. The Difluoriodate Series

By Arthur Finch,* P. N. Gates, and M. A. Jenkinson, Royal Holloway College, Englefield Green, Surrey

Reprinted from

JOURNAL
OF
THE CHEMICAL SOCIETY

DALTON TRANSACTIONS

1972

Thermochemistry of Fluorine Compounds. Part I. The Difluoriodate Series

By Arthur Finch,* P. N. Gates, and M. A. Jenkinson, Royal Holloway College, Englefield Green, Surrey

From measurements of the heats of aqueous alkaline hydrolysis at 25 °C the standard enthalpies of formation of the following fluoriodates are derived: $\Delta H_f^\circ[\text{NaIO}_2\text{F}_2, \text{cryst.}]_{298} = 202.8 \pm 0.3 \text{ kcal mol}^{-1}$ ($-848.7 \pm 1.2 \text{ kJ mol}^{-1}$); $\Delta H_f^\circ[\text{KIO}_2\text{F}_2, \text{cryst.}]_{298} = -209.5 \pm 0.3 \text{ kcal mol}^{-1}$ ($-876.6 \pm 1.2 \text{ kJ mol}^{-1}$); $\Delta H_f^\circ[\text{RbIO}_2\text{F}_2, \text{cryst.}]_{298} = -209.2 \pm 0.3 \text{ kcal mol}^{-1}$ ($-875.3 \pm 1.2 \text{ kJ mol}^{-1}$) and $\Delta H_f^\circ[\text{NH}_4\text{IO}_2\text{F}_2, \text{cryst.}]_{298} = -178.7 \pm 0.3 \text{ kcal mol}^{-1}$ ($-754.6 \pm 1.2 \text{ kJ mol}^{-1}$). Estimates of lattice energies and other thermodynamic parameters are also reported.

THE oxyanion chemistry of fluorine is extremely limited: oxyfluoro-ions are very rare and the only example of a charged iodo-oxyfluoro-species is the IO_2F_2^- anion. The preparation of various fluoriodates MIO_2F_2 ($\text{M} = \text{Li}, \text{Na}, \text{and K}$) is well established¹ and the structure of KIO_2F_2 has been the subject of a single-crystal X-ray investigation.² No thermodynamic data are available.

EXPERIMENTAL

Preparations.—The compounds MIO_2F_2 ($\text{M} = \text{Na}, \text{K}, \text{Rb}, \text{and NH}_4$) were prepared by the established procedure of the appropriate iodate with 40% aqueous hydrogen fluoride in polyethylene beakers at room temperature. Well-formed crystals of fluoriodates appeared after prolonged standing in a well-ventilated fume cupboard; the supernatant liquid was decanted, the crystals washed with dry diethyl ether, dried in a stream of dry nitrogen, and stored and subsequently manipulated with rigorous protection from moisture. Each sample was analysed for iodine (titrimetrically) and for fluorine (with a selective ion electrode) (Found: I, 57.7; F, 17.3. Calc. for NaIO_2F_2 : I, 57.7; F, 17.3%; Found: I, 53.8; F, 16.0. Calc. for KIO_2F_2 : I, 53.8; F, 16.1%; Found: I, 45.2; F, 13.4. Calc. for RbIO_2F_2 : I, 44.9; F, 13.5%; Found: I, 59.1; F, 17.4. Calc. for $\text{NH}_4\text{IO}_2\text{F}_2$: I, 59.0; F, 17.7%). The presence of the fluoriodate ion in each sample was confirmed by analysis of the Raman spectrum of powdered samples obtained by use of a Cary 81 Raman spectrometer equipped with a helium-neon laser and employing the 6328 Å line for excitation.

Calorimeter and Procedure.—The calorimeter has been described,³ and was operated at $298.15 \pm 0.01 \text{ K}$ in the isoperibol mode. Duplicate, identical calorimeters were used. All parts were fabricated from borosilicate glass,

¹ R. F. Weinland and O. Lauenstein, *Z. anorg. Chem.*, 1899, 20, 30.

² L. Helmholz and M. T. Rogers, *J. Amer. Chem. Soc.*, 1940, 62, 1537.

and vacuum-jacketing employed; thermistors (Standard Telephone and Cable Company Limited, model F 23) were used as sensing elements and results were displayed on a potentiometric recorder. The performance was checked periodically by use of the neutralisation of tris-(hydroxymethyl)aminomethane (tham) in excess of aqueous 0.1000N-hydrochloric acid as test reaction. Typical results were: $\Delta H(298 \text{ K}, 1246 < N < 1441) = 7.10 \pm 0.01 \text{ kcal mol}^{-1}$ (eleven consecutive runs) [lit.,⁴ $\Delta H(298 \text{ K}, 1180 < N < 1574) = 7.109 \pm 0.001 \text{ kcal mol}^{-1}$]. Appropriate amounts of fluoriodate in glass ampoules were broken into an excess of aqueous 0.1000N-sodium hydroxide (200 ml). The calorimetric reaction was fast, but not violent, and values of the heat of reaction ΔH_{obs} were measured according to the equation (1). In all runs, reaction was carried out

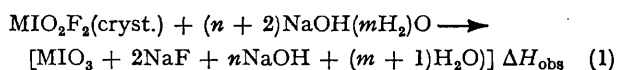

at $298.15 \pm 0.01 \text{ K}$ with the mole ratio $\text{NaOH}:\text{H}_2\text{O} = 1:555$. Uncertainties are taken as twice the standard deviation of the mean. One kcal is taken as 4.1840 absolute joules.

RESULTS

Experimental calorimetric results are summarised in Table 1. The measured reaction heat, ΔH_{obs} , refers to process (1), where $\text{M} = \text{Na}, \text{K}, \text{Rb}, \text{or NH}_4$, as appropriate. The standard enthalpy of formation of each fluoriodate was calculated by substitution of the observed value of ΔH_{obs} and appropriate ancillary data (Table 2) into the thermochemical equation (2). Results are in Table 3.

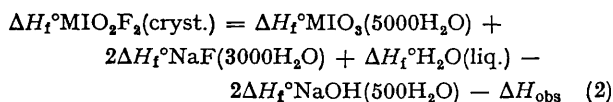

³ R. L. Coley, Ph.D. Thesis, University of London, 1971.

⁴ J. O. Hill, G. Öjelund, and I. Wadsö, *J. Chem. Thermodynamics*, 1969, 1, 111.

TABLE 1
Experimental data for aqueous alkaline hydrolysis of
some Group IA fluoriodates

Compound	w/g	$-\Delta H_{\text{obs}}$ kcal mol ⁻¹	
NaIO ₂ F ₂ (cryst.)	0.6042	25.26	
	0.3806	25.23	
	0.7676	25.86	
	0.6762	25.98	
	0.6975	25.38	
	0.8802	25.46	
	0.5423	25.19	
	0.9015	24.97	
	0.5190	25.30	
	0.7176	24.86	
	0.4873	24.95	
	$\Delta H_{\text{obs}}(\text{mean}) = -25.31 \pm 0.22$ kcal mol ⁻¹		
KIO ₂ F ₂ (cryst.)	0.3334	21.95	
	0.5178	21.16	
	0.3653	22.54	
	0.5521	21.70	
	0.5589	20.56	
	0.5393	21.77	
	0.6956	20.43	
	0.5985	21.24	
	0.6400	21.31	
	0.5490	21.33	
	0.7270	21.24	
	0.7267	20.87	
$\Delta H_{\text{obs}}(\text{mean}) = -21.34 \pm 0.34$ kcal mol ⁻¹			
RbIO ₂ F ₂ (cryst.)	0.7756	20.66	
	0.7736	20.70	
	0.6864	20.80	
	0.6961	20.74	
	0.5204	21.18	
	0.5379	20.77	
	0.7693	20.42	
	0.7390	20.55	
	0.6263	20.74	
	0.8083	20.66	
	$\Delta H_{\text{obs}}(\text{mean}) = -20.72 \pm 0.12$ kcal mol ⁻¹		
	NH ₄ IO ₂ F ₂ (cryst.)	0.3903	24.97
0.3682		24.63	
0.5253		24.62	
0.4932		24.44	
0.3378		24.81	
0.4767		24.83	
0.3440	24.97		
$\Delta H_{\text{obs}}(\text{mean}) = -24.75 \pm 0.16$ kcal mol ⁻¹			

TABLE 2
Ancillary heat of formation data (298 K)

Compound	ΔH_f° kcal mol ⁻¹	Compound	ΔH_f° kcal mol ⁻¹
NaOH(500H ₂ O)	-112.12	NaIO ₃ (5000H ₂ O)	-112.28
NaF(3000H ₂ O)	-135.90	KIO ₃ (5000H ₂ O)	-114.98
RbF(5000H ₂ O)	-137.57	NH ₄ F(5000H ₂ O) *	-111.17
H ₂ Q(liq.) *	-68.31 ₅		

* D. D. Wagman, W. H. Evans, V. B. Parker, I. Halow, S. M. Bailey, and R. H. Schumm, 'Selected Values of Chemical Thermodynamic Properties,' Technical Note 270-3, 1968, U.S. Govt. Printing Office. All other data from F. D. Rossini, D. D. Wagman, W. H. Evans, S. Levine, and I. Jaffe, National Bureau of Standards Circular 500, Part I, 1952, U.S. Govt. Printing Office.

TABLE 3
Derived standard enthalpies of formation

Compound	$\Delta H_f^\circ(298\text{ K})$ kcal mol ⁻¹	$\Delta H_f^\circ(298\text{ K})$ kJ mol ⁻¹
NaIO ₂ F ₂ (cryst.)	-202.8 ₅ ± 0.3	-848.7 ± 1.2
KIO ₂ F ₂ (cryst.)	-209.5 ± 0.4	-876.6 ± 1.6
RbIO ₂ F ₂ (cryst.)	-209.2 ± 0.3	-875.3 ± 1.2
NH ₄ IO ₂ F ₂ (cryst.)	-178.7 ± 0.3	-754.6 ± 1.2

DISCUSSION

The substantial negative values obtained for the standard enthalpies of formation of the fluoriodates, *ca.* -10² kcal mol⁻¹, are consistent with their apparent stability on storage for long periods. A more useful thermodynamic parameter for ionic crystals, however, is that of the lattice energy, U° , which may be equated, without significant error, with the internal energy change U_{298} accompanying the dissociation of the crystal into gas ions, *viz.*, equation (3). Only for

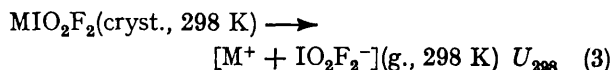

KIO₂F₂ is it possible, even in principle, to calculate a value for the Madelung constant, but no value for the repulsive coefficient is available. Hence it is more reasonable to compute a self-consistent set of lattice energies by use of the Born-Mayer form of the Kapustinskii equation,⁵ which can be written as (4) where $\nu = U_{298}$ (kcal mol⁻¹) =

$$\frac{287 \cdot 2 \nu z_1 z_2}{r(\text{M}^+) + r(\text{IO}_2\text{F}_2^-)} \left[1 - \frac{0.345}{r(\text{M}^+) + r(\text{IO}_2\text{F}_2^-)} \right] + 2.5 \nu z_1 z_2 \quad (4)$$

number of ions in 'molecule' [*i.e.*, 2] and z_1, z_2 , are the charges on the cation and anion respectively [*i.e.*, each 1]. Values for the crystal ion radii, $r(\text{M}^+)$ and $r(\text{IO}_2\text{F}_2^-)$, are required; the former are readily available and the latter is best calculated by the well-established Yatsimirskii 'thermochemical radius' procedure.⁶ For two crystalline compounds, M'X and M''X, we have equation (5) where $\Delta H_L'$, $\Delta H_L''$ are the lattice enthalpies

$$\Delta H_L' - \Delta H_L'' = U_T' - U_T'' = \Delta H_f^\circ \text{M}'+(\text{g.}) - \Delta H_f^\circ \text{M}''+(\text{g.}) - \Delta H_f^\circ \text{M}'\text{X}(\text{cryst.}) + \Delta H_f^\circ \text{M}''\text{X}(\text{cryst.}) \quad (5)$$

of the M'X and M''X respectively. Since the quantity [$U_T' - U_T''$] can be expressed in terms of the Kapustinskii equation (4) written for each compound, a value for $r(\text{IO}_2\text{F}_2^-)$ can be calculated. This calculation was performed for NaIO₂F₂ and KIO₂F₂, by use of the ancillary data in Table 4, and solving the appropriate

TABLE 4
Data used to compute a value for the thermochemical radius of the IO₂F₂⁻ ion

Species	Standard enthalpies of formation 298 K kcal mol ⁻¹	Ion radius (cryst.)/Å
NaIO ₂ F ₂	-203(cryst.)	
KIO ₂ F ₂	-210(cryst.)	
Na ⁺	-146(g.) *	1.00 *
K ⁺	-123(g.) *	1.33 *

* D. A. Johnson, 'Some Thermodynamic Aspects of Inorganic Chemistry,' Cambridge University Press, 1968.

⁵ A. F. Kapustinskii, *Quart. Rev.*, 1956, **10**, 283; see also T. C. Waddington, 'Advances in Inorganic and Radiochemistry,' eds. H. J. Emeléus and A. G. Sharpe, vol. 1, Academic Press, 1959, p. 157.

⁶ K. B. Yatsimirskii, *Russ. J. Inorg. Chem.*, 1961, **6**, 265; see also T. C. Waddington, *ref. 5*.

quartic equation for $r(\text{IO}_2\text{F}_2^-)$ whence $r(\text{IO}_2\text{F}_2^-) = 1.8_3$ Å. This was adopted for subsequent lattice-energy computations, results for 1:1 crystals are shown in Table 5. It is probably not meaningful to attempt to

TABLE 5

Calculated values of lattice energies of some 1:1 fluoriodate crystals, MIO_2F_2

M	Li	Na	K	Rb	Cs	Ag	NH ₄
$U_{998}/\text{kcal mol}^{-1}$	202	183	167	161	152	176	162

ascribe precise error limits to these values. A major uncertainty is the validity of the value of $r(\text{IO}_2\text{F}_2^-)$, a change of 0.1 Å in which is reflected by a lattice-energy value change of *ca.* 10 kcal mol⁻¹. Differences in values of lattice energies are clearly much more precise than the absolute values. Using the relationship (6) we can, using known values for the standard heats of formation of NaIO_2F_2 , KIO_2F_2 , and RbIO_2F_2 ,

$$\Delta H_f^\circ \text{MIO}_2\text{F}_2(\text{cryst.}) = \Delta H_f^\circ \text{IO}_2\text{F}_2(\text{g.}) - U_T - \frac{2RT + \Delta H_f^\circ \text{M}^+(\text{g.})}{6} \quad (6)$$

calculate a value for $\Delta H_f^\circ \text{IO}_2\text{F}_2^-(\text{g.})$ of -164.8 ± 0.6 kcal g-ion⁻¹, the error limits referring solely to the

precision of the three calculated results. Substitution of this value in equation (3) with appropriate literature values of $\Delta H_f^\circ \text{M}^+(\text{g.})$ and calculated values of $U_T \text{MIO}_2\text{F}_2$ now enables the estimation of the standard heats of formation of other 1:1 metal fluoriodate crystals. A simple extrapolation method, based on comparing the differences between experimental values for the standard heats of formation of pairs of alkali-metal salts, *e.g.*, sodium and potassium chloride, sodium and potassium bromide, *etc.*, leads to a value of $\Delta H_f^\circ \text{CsIO}_2\text{F}_2^-(\text{cryst.}) = -210$ kcal mol⁻¹. This, while not an independent check of the calculation from equation (6), lends support to this method as realistic. Further extension to calculations of lattice energies and standard heats of formation of Group IIA fluoriodates, $\text{M}^{2+}(\text{IO}_2\text{F}_2^-)_2$, leads to values of reasonably predictable magnitudes. The apparent non-existence of these compounds may hence depend on the insolubility of the parent Group IIA iodates, which presumably precludes their use as synthetic precursors.

We thank the S.R.C. for financial support (to M. A. J.).

[2/738 Received, 28th March, 1972]