

THE UPTAKE OF VITAMIN B12 BY UNICELLULAR ALGAE

Mark Letchford Borley

A thesis submitted for the degree of Doctor  
of Philosophy in the University of London

Royal Holloway and Bedford  
New College

January 1987

ProQuest Number: 10090129

All rights reserved

INFORMATION TO ALL USERS

The quality of this reproduction is dependent upon the quality of the copy submitted.

In the unlikely event that the author did not send a complete manuscript and there are missing pages, these will be noted. Also, if material had to be removed, a note will indicate the deletion.



ProQuest 10090129

Published by ProQuest LLC(2016). Copyright of the Dissertation is held by the Author.

All rights reserved.

This work is protected against unauthorized copying under Title 17, United States Code.  
Microform Edition © ProQuest LLC.

ProQuest LLC  
789 East Eisenhower Parkway  
P.O. Box 1346  
Ann Arbor, MI 48106-1346

ABSTRACT.

Vitamin B12 binding and uptake by two unicellular, marine algae, the autotrophic Dunaliella primolecta and the auxotrophic Pavlova lutheri, has been studied.

Features of the extracellular binders found in the culture medium of micro-algae were examined to elucidate their role. The B12 binding capacity of these proteins was shown to be proportional to cell density, and they were relatively stable for at least one month. Nevertheless, cells bind the majority of vitamin until stationary phase.

Membrane-bound and intracellular cytosolic binders have also been isolated, representing around 49 and 16 % respectively of the total B12 binding capacity of cultures, 35 % typically being associated with the extracellular fraction. To discover the relationship between these proteins and the nature of the uptake process, characterisation was pursued. An affinity chromatography-based purification scheme was developed for the binders, and small quantities of these proteins were purified from all three phases. Gel filtration showed uniform molecular weights in excess of 500 000, and amino acid analyses revealed similar compositions. The identification of carbohydrate components was investigated using a lectin-binding assay.

However, it was not found to be possible to determine sub-unit molecular weight by SDS gel electrophoresis, and attempts at localisation of the cellular B12 binding sites using fluorescence microscopy and electron probe micro-analysis were unsuccessful. Interestingly though, similar vitamin binding characteristics were demonstrated for isolated chloroplasts and intact cells of D.primolecta.

Aspects of B12 and its uptake by micro-algae are reviewed, and an explanation for extracellular B12 binding proteins involving non-specific release is suggested. A general model of two-stage uptake of the vitamin by micro-algae, with a primary stage of binding to a receptor protein in the plasma membrane and a secondary phase of energy-dependent internalisation, is also proposed.

TABLE OF CONTENTS.

Title page	1
Abstract	2
Table of Contents	4
List of Figures	7
List of Plates	10
List of Tables	12
List of Abbreviations	15
Chapter 1 - General introduction	
1.1 Algal vitamin requirements	17
1.2 Vitamin B12 and its analogues	21
1.3 Functions of vitamin B12 in algae	25
1.4 Vitamin B12 uptake mechanisms	29
1.5 Structure and characteristics of the algae	46
1.6 Vitamin B12 and algal ecology	49
Chapter 2 - The development of culturing and B12 binding assay methodology	
Introduction	58
Materials and methods	59
Results	65
Discussion	76

Chapter 3 - An investigation of the general characteristics of algal B12 binding proteins

Introduction	78
Materials and methods	79
Results	84
Discussion	94

Chapter 4 - The development of a purification system for algal B12 binding proteins

Introduction	98
Materials and methods	99
Results	110
Discussion	121

Chapter 5 - Characterisation of the algal vitamin B12 binding proteins

Introduction	128
Materials and methods	129
Results	134
Discussion	155

Chapter 6 - Localisation of cellular B12 binding sites

Introduction	161
Materials and methods	162
Results	167
Discussion	175

Chapter 7 - A comparison of B12 binding by algal cells and chloroplasts	
Introduction	178
Materials and methods	179
Results	182
Discussion	191
Chapter 8 - Summary and general discussion	196
Acknowledgements	212
References	213

LIST OF FIGURES INCLUDED IN THE TEXT.

Figure 1.1	The structure of vitamin B12 ( $\alpha$ -5,6 -dimethylbenzimidazolyl cyanocobalamin)	22
Figure 1.2	The spatial formula of 5'deoxy- adenosyl cobalamin	23
Figure 1.3	The proposed mammalian vitamin B12 uptake system	33
Figure 1.4a and 1.4b	Two alternative schemes for bacterial B12 uptake	38
Figure 2.1	The Amicon Micro Partition System used to separate free and bound vitamin B12	63
Figure 2.2	Absorbance measured at 675 nm against cell density of <u>D.primolecta</u> and <u>P.lutheri</u> cultures	66
Figure 2.3	The counting efficiency of $^{57}\text{Co}$ B12 in different radioactivity counting systems	70
Figure 2.4	The effect of different volumes of ultrafiltrate collected on the B12 binding capacity of filtered <u>D.primolecta</u> medium as estimated by ultrafiltration assay	72



Figure 2.5	The effect of different incubation periods of $^{57}\text{Co}$ B12 with filtered <u>D.primolecta</u> medium on the estimated binding capacity	73
Figure 2.6	The estimated B12 binding capacity of filtered <u>D.primolecta</u> and <u>P.lutheri</u> media with different dilution factors used for assay	74
Figure 3.1	The procedure used to isolate extra-cellular, intracellular and membrane-bound product fractions from algal cultures	82
Figures 3.2 and 3.3	The cell density, extra-cellular B12 binding and total extracellular protein production of <u>D.primolecta</u> and <u>P.lutheri</u> monitored throughout the growth curve	85
Figures 3.4, 3.5 and 3.6	The concentration dependence and partition of B12 binding by cells and extracellular binder of <u>P.lutheri</u> at three stages in the growth curve	90
Figure 3.7	The relative total B12 binding capacities of proteins isolated from the extracellular, intracellular and membrane-bound fractions of <u>D.primolecta</u> and <u>P.lutheri</u>	93
Figure 4.1	A diagrammatic representation of the coupling of APC to affi gel 10 and CN-Br activated sepharose 4B matrices	106

Figure 4.2	A diagrammatic representation of the purification scheme developed for algal B12 binding proteins	125
Figure 5.1	The calibration curve obtained when running standard proteins on a sephadex G-200 gel filtration column	136
Figures 7.1 and 7.2	The amount of B12 bound by cells and chloroplasts of <u>D.primolecta</u> when incubated with different concentrations of B12	187
Figures 7.3 and 7.4	B12 binding by cells and chloroplasts of <u>D.primolecta</u> during the first minute of incubation with the vitamin	188
Figures 7.5 and 7.6	The course of B12 binding by cells and chloroplasts of <u>D.primolecta</u> over a four hour incubation period	189
Figure 7.7	The course of cellular and extra-cellular B12 binding by <u>D.primolecta</u> over a 7.5 hour incubation period	190
Figure 8.1	A diagrammatic representation of B12 binding and uptake by micro-algae	206

LIST OF PLATES INCLUDED IN THE TEXT.

Plate 4.1	The elution of free and binding protein-complexed APC from a sephadex G-75 gel filtration column	118
Plate 5.1	The elution of purified binding protein complexed to APC from a sephadex G-200 gel filtration column	138
Plate 5.2	SDS gel electrophoresis of purified <u>D.primolecta</u> EBP and standard proteins	141
Plate 5.3	Amino acid analysis of a purified <u>D.primolecta</u> EBP sample	144
Plate 5.4	Amino acid analysis of a 25 nM standard amino acid solution	146
Plate 5.5	Amino acid analysis of a typical purified binding protein sample	148
Plate 6.1	Micrographs of <u>D.primolecta</u> cells under transmitted visible and incident U-V illumination after treatment with rabbit anti-B12 and FITC labelled anti-rabbit sera	169
Plate 6.2	Electron micrograph of a whole cell of <u>Dunaliella primolecta</u> in L.S.	172

Plate 6.3 Electron micrograph showing cells of <u>D.primolecta</u> prepared for TEM without osmium treatment	174
Plate 7.1a Intact cells of <u>D.primolecta</u> under phase contrast illumination	184
Plate 7.1b Chloroplasts isolated from <u>D.primolecta</u> by DEAE-dextran lysis observed under phase contrast illumination	184
Plate 7.1c Isolated intact and ruptured chloroplasts from <u>D.primolecta</u> under phase contrast illumination, showing the effect of excess DEAE-dextran on chloroplasts	184

LIST OF TABLES INCLUDED IN THE TEXT.

Table 2.1	The composition of the modified ASP2 medium adopted	60
Table 2.2	The composition of Bray's scintillant	60
Table 2.3	The effect of variations in the composition of ASP2 growth medium and illumination on the final yield and time taken to reach maximum density of <u>D.primolecta</u> cultures	67
Table 2.4	The efficiency of the MPS ultrafiltration system for separating free and bound B12	71
Table 2.5	Variation in the estimated B12 binding capacity of <u>D.primolecta</u> medium with different dilution factors used for assay	75
Table 3.1	The B12 binding capacity of the extracellular proteins of <u>D.primolecta</u> and <u>P.lutheri</u> retained after storage under various conditions	87
Table 3.2	The average total B12 binding capacity associated with the three product fractions isolated from <u>D.primolecta</u> and <u>P.lutheri</u>	92
Table 3.3	The variation in the proportions of B12 binding capacity isolated from the three product phases of <u>D.primolecta</u>	92

Table 4.1	The method for preparation of 3' amino -propylcobalamin from hydroxocobalamin	102
Table 4.2	The B12 binding capacity present in filtered original, and calcium phosphate gel treated, <u>D.primolecta</u> medium and phosphate buffers used to elute binder from the gel	111
Table 4.3	The proportion of B12 binding activity in <u>D.primolecta</u> and <u>P.lutheri</u> media retained after various concentration techniques and dilution to original volume	112
Table 4.4	The effect of flow rate through an APC-sepharose 4B column on the recovery of <u>D.primolecta</u> extracellular binding protein	115
Table 4.5	A comparison of the binding effi- ciency of <u>D.primolecta</u> EBP to APC-affi gel 10 and APC-sepharose 4B affinity columns at varying flow rates	115
Table 4.6	The effect of temperature on the binding efficiency of <u>D.primolecta</u> EBP to APC-affi gel 10 using continuous flow and batch mixing methods	115
Table 4.7	The effect of incubating filtered <u>P.lutheri</u> medium with sephadex gel filtration matrices	119

Table 4.8	The quantity of purified <u>D.primolecta</u> extracellular binding protein as estimated by three different methods	120
Table 5.1	The amino acid composition of <u>D.primolecta</u> extracellular binding protein	149
Table 5.2	The ratios of the nM concentrations of amino acids found in the B12 binding proteins of <u>D.primolecta</u> and <u>P.lutheri</u>	150
Tables 5.3 and 5.4	The percentage of the B12 binding capacity of the three fractions isolated from <u>D.primolecta</u> and <u>P.lutheri</u> retained after incubation with carbohydrate-binding immobilised lectins	153 154
Table 6.1	The schedule used to prepare algal unicells for transmission electron microscopy	166

LIST OF ABBREVIATIONS USED IN THE TEXT.

EBP	Extracellular B12 binding protein
IBP	Intracellular cytosolic B12 binding protein
MBP	Membrane-bound B12 binding protein
APC	3'aminopropyl-cobalamin
CBB	Coomassie brilliant blue
EPMA	Electron probe micro analysis
FITC	Fluorescein isothiocyanate
Fuc	Fucose
Gal	Galactose
N-Ac-Gal	N-acetyl galactosamine
Glc	Glucose
N-Ac-Glc	N-acetyl glucosamine
Man	Mannose
PAR	Photosynthetically available radiation
PPO	2,5-diphenyloxazole
POPOP	1,4-di(2,5-phenyloxazolyl) benzene
PS	Phosphate / Saline buffer
TEMED	Tetramethylethylenediamine



LIST OF ABBREVIATIONS (continued).

IF        Mammalian intrinsic factor

CP        Mammalian cobalophilin

TC        Mammalian transcobalamin

---

CHAPTER 1 - GENERAL INTRODUCTION.

1.1 ALGAL VITAMIN REQUIREMENTS

For many years it was thought that algae were completely autotrophic and did not require any exogenous organic nutrients. This was largely due to the success of the early culturing of green algae and diatoms in inorganic media. Consequently, the availability and uptake of vitamins was not considered important for phytoplankton.

The first discovery that a vitamin was an essential growth factor for an alga was made by Lwoff and Dusi in 1937, who established that thiamine was required by the colourless flagellate Polytomella coeca. It was another twelve years before vitamin B12, cyanocobalamin, was first identified as an algal growth requirement when its role in culturing Euglena gracilis was recognized (Hutner, Provasoli, Stokstad, Belt, Franklin and Jukes 1949).

Since then, over four hundred algal species have been found to need one or more of the three vitamins cyanocobalamin, thiamine or biotin, vitamin B12 being the most widespread requirement. (Provasoli and Carlucci 1974). This necessity for an external vitamin supply in otherwise autotrophic organisms is known as

auxotrophy.

The pattern of vitamin requirements varies in the different algal groups. The Bacillariophyceae, Chrysophyceae, Cryptophyceae, Dinophyceae and Euglenophyceae all show a predominance of auxotrophic species, while members of the Chlorophyceae, Cyanophyceae, Xanthophyceae and Phaeophyceae are least likely to require vitamins.

However, there is no definitive pattern to vitamin requirements. Within a genus there may be both autotrophic and auxotrophic species (Provasoli 1958, 1963), and there can even be strains of the same species with different requirements e.g. Phaeodactylum tricornatum (Lewin and Lewin 1960) and Coccolithus huxleyi (Guillard 1968). Indeed, autotrophic clones maintained in vitamin-containing media for long periods may show a tendency to develop auxotrophy (Provasoli and Carlucci 1974). It has also been shown that a vitamin requirement can be induced in autotrophic blue-green algae by mutagenic conditions (Herdman and Carr 1972). Thus auxotrophy does not appear to bear any direct relationship to phylogeny, but is an independent loss of ability to synthesise a vitamin.

The concentration of any vitamin required by algae is extremely small, but varies between organisms. In Pavlova lutheri the B12 half saturation constant for growth i.e. the concentration supporting half maximal

growth rate, is  $2.8 \text{ ng l}^{-1}$  (Swift and Taylor 1974), while in Ochromonas malhamensis it is  $13 \text{ ng l}^{-1}$  (Ford 1958).

The typical vitamin B12 content of algae varies from 3 to  $291 \text{ ng g}^{-1}$  dry weight, while thiamine varies from 0.27 to  $23 \text{ } \mu\text{g g}^{-1}$  and biotin from 18 to  $294 \text{ ng g}^{-1}$  (Kanazawa 1963). There is a wide variation in vitamin content within algal groups showing little trend.

The internal concentrations of auxotrophs in particular are known to depend on the vitamin level in the external medium, starved cultures containing less vitamin (Carlucci and Bowes 1972). However, the ratio of intracellular to extracellular B12 is not constant (Bradbeer 1971).

Continuous culturing results in higher internal vitamin levels than those found in batch cultures (Droop 1968). Internal concentration also varies according to whether nutrition is autotrophic or heterotrophic, the latter resulting in B12 concentrations lower than  $0.04 \text{ ng g}^{-1}$  dry weight (Robbs, Rosenberg and Costa 1983). However, it is interesting that the minimal requirement for a given cell volume is approximately the same for all micro-organisms, this figure being 2 - 3 molecules per  $\mu\text{m}^3$  cell volume (Bradbeer 1971; Droop 1957).

The sensitivity to low concentrations has led to the use of algae as bioassay organisms for vitamin B12.

For example, assays have been developed for both Euglena gracilis (Hutner, Bach and Ross 1956) and Cyclotella nana (Ryther and Guillard 1962). Bioassays have also been developed for thiamine using Pavlova lutheri (Carlucci and Silbernagel 1966), and biotin using Amphidinium carteri (Carlucci and Silbernagel 1967). Overall though, most work has been concentrated on vitamin B12.

A pattern of a substrate saturable growth response to B12 has been found for auxotrophs. This is typically described by the Michaelis-Menten or Monod equations (Ford 1958; Swift and Taylor 1974), which produce hyperbolic curves.

In general, autotrophs are not thought to show any change in growth rate in response to the external B12 concentration (Swift 1980). In a few cases, the growth of facultative autotrophs, most notably among the diatoms, is stimulated by the vitamin (Swift and Guillard 1978).

Droop (1974) has shown that the internal concentration of the nutrient is of prime importance in determining specific growth rate. Therefore, since B12 is obtained from the environment, the kinetics of uptake can control algal growth rates.

## 1.2 VITAMIN B12 AND ITS ANALOGUES

Vitamin B12 ( $\alpha$ -5,6-dimethyl benzimidazolyl cyano-cobalamin) is based on a porphyrin ring structure and is one of the corrinoid group of compounds. The molecular weight is 1355 and its structure is shown in Figure 1.1. The molecule has three major portions :

(1) A central cobalt atom bound to four pyrrol rings to form an almost planar corrin ring.

(2) A nucleotide like side chain,  $\alpha$ -5,6-dimethyl benzimidazole-D-ribofuranose phosphate. This side chain is bound beneath the plane of the ring between the cobalt atom, and a side chain on one of the pyrrol rings.

(3) The cobalt atom has a sixth bond above the plane of the ring to a cyanogen group, which is replaced by other functional groups in coenzyme forms of the vitamin (Smith 1965).

The naturally occurring form of vitamin B12 in water, soil and culture conditions is hydroxo-cobalamin in which the cyanogen group is replaced by a hydroxyl group (Sebrell and Harris 1968). Within cells the vitamin is most commonly found in a coenzyme form in which the cyanogen group is replaced by a 5'deoxyadenosyl moiety (Smith 1965). The spatial

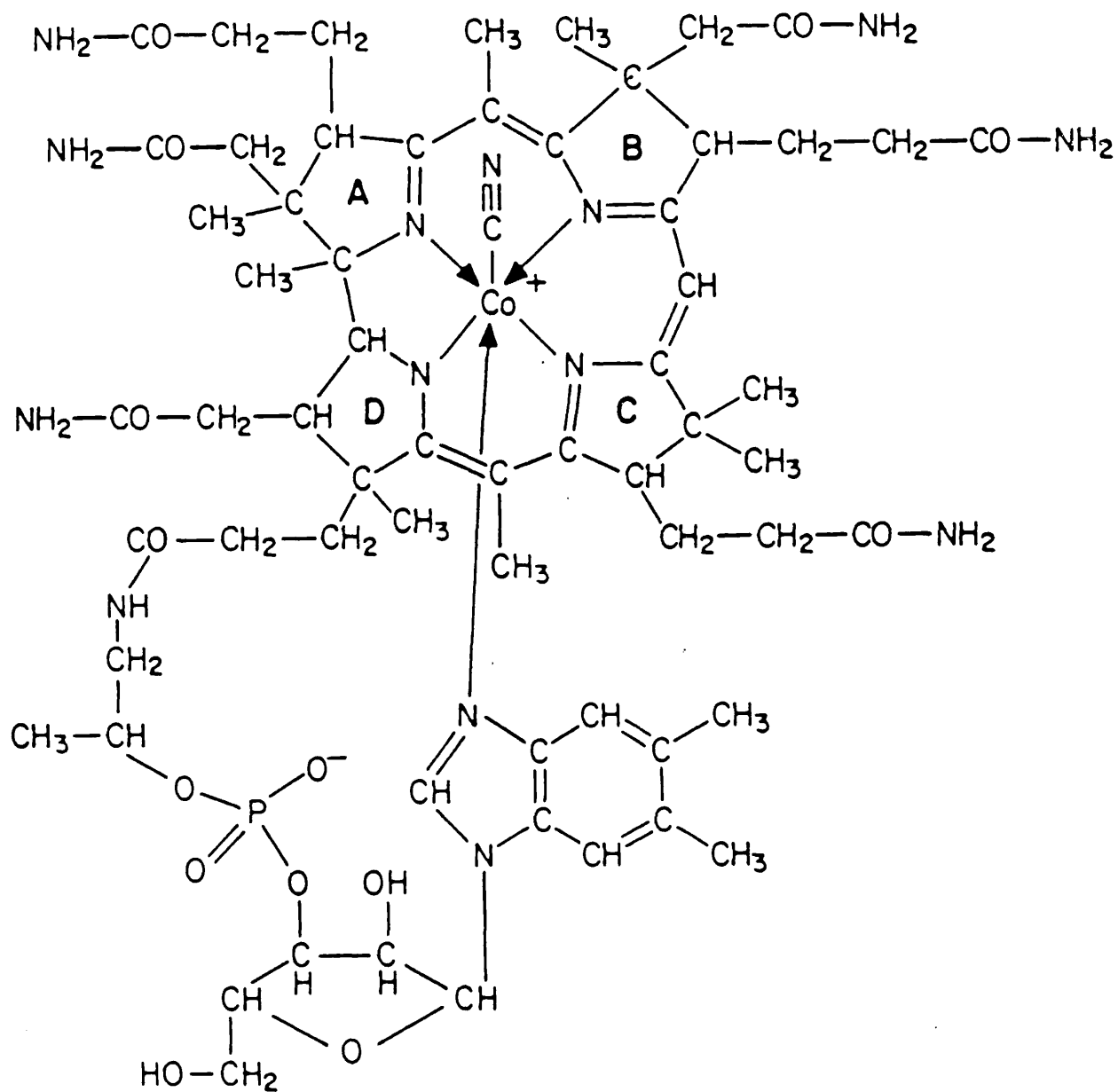

Figure 1.1 The structure of vitamin B12 (α- 5,6 - dimethyl benzimidazolyl cyanocobalamin).

(From Smith 1965).

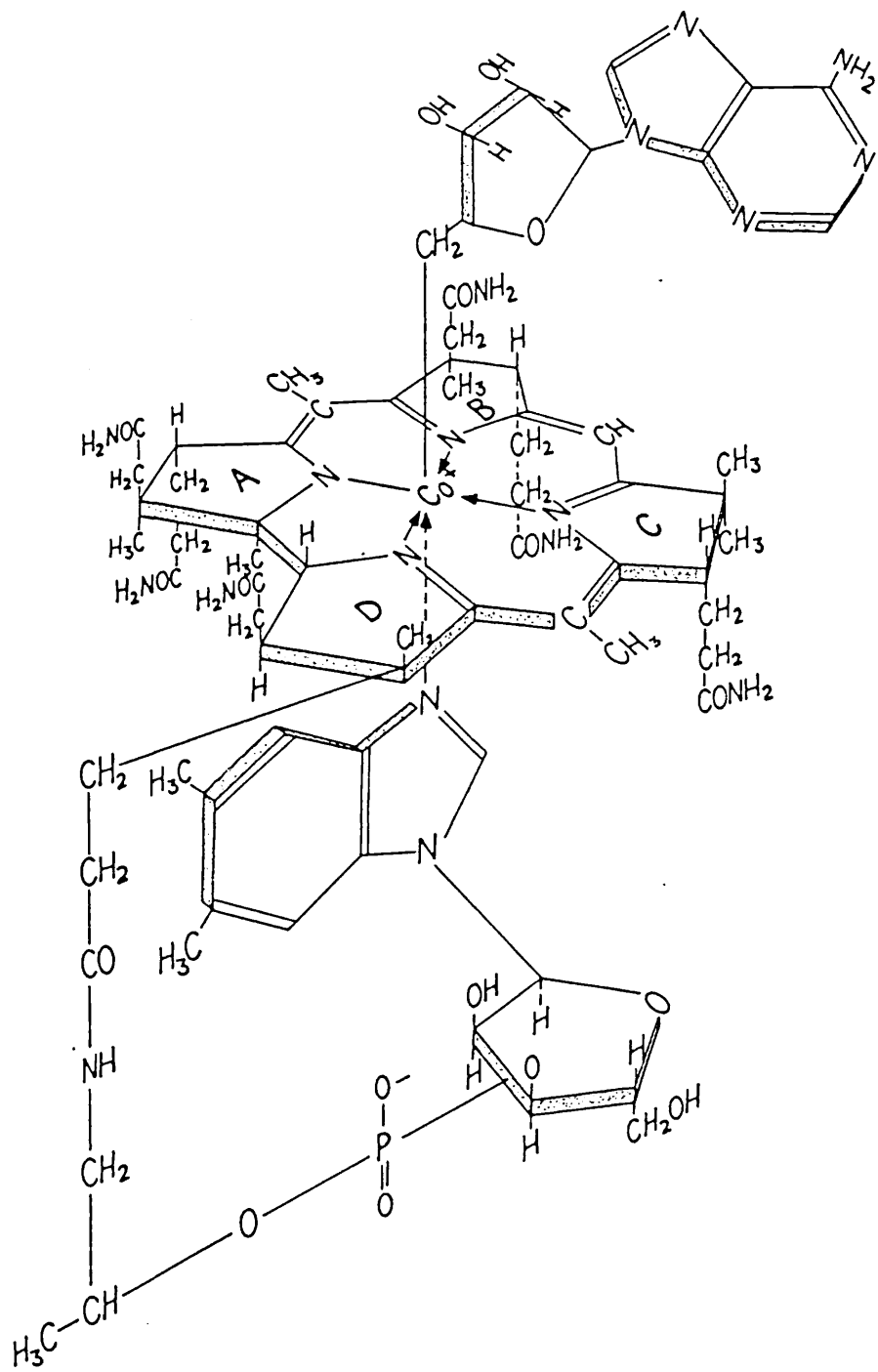

Figure 1.2 The spatial formula of 5' deoxyadenosylcobalamin. (From Smith 1965).



formula of this is shown in Figure 1.2. Another coenzyme form is methyl-cobalamin which has a methyl group in the corresponding position (Barker 1972).

Other analogues of vitamin B12 exist because some micro-organisms synthesise and utilize slightly different forms of the vitamin. Unlike cyanocobalamin, these analogues cannot be utilized by all B12-requiring organisms. They can be divided into three groups depending on the type of side chain present, which determines the ability of organisms to utilize them.

Group 1: Corrinoids with a dimethylbenzimidazole side chain, given the trivial name cobalamin (Cbl). This group includes cyano-Cbl, adenosyl-Cbl, methyl-Cbl, hydroxo-Cbl and aqua-Cbl.

Group 2: Corrinoids with a purine base substituted in the nucleotide side chain in place of benzimidazole. Examples of this are factor A, with 2-methyladenine, and pseudovitamin B12, with adenine in the side chains.

Group 3: Corrinoids without a side chain, the most important example being factor B, cobinamide dicyanide.

Similarly, organisms requiring B12 can be classified into three types on the basis of their ability to utilize the three groups of analogues.

Those able to use only group 1 analogues have mammalian type (M) specificity.

Lactobacillus leichmannii (L) type specificity is shown by those which can utilize analogues with either type of side chain (groups 1 and 2).

Organisms which can utilize any of the analogues have Escherichia coli or wide type specificity (C).

Some algal groups show only one type of specificity; for example the Chlorophyceae are all type M. Other groups, such as the Bacillariophyceae, show all three specificities (Provasoli and Carlucci 1974).

There are, therefore, variations among algae in the consumption of the various forms of B12 available, and a complete range of different utilizations is shown.

### 1.3 FUNCTIONS OF VITAMIN B12 IN ALGAE

In general, vitamin B12 functions as an enzyme co-factor in reactions involving intramolecular shifts of carbon or hydrogen, and in group transfer reactions (Swift 1980). Its predominant role is the migration of a hydrogen atom from one carbon atom to an adjacent one, with the concomitant migration of an alkyl, acyl or electronegative group in the reverse direction

(Dolphin, Banks, Cullen, Cutler and Silverman 1979).

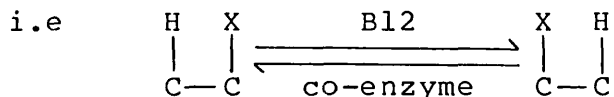

The essential common step in all its reactions is a cleavage of the cobalt-carbon bond above the plane of the corrin ring (Dolphin et al. 1979). Hence the importance of the functional group attached to the cobalt atom in this position for co-enzyme activity.

The commonest co-enzyme form of B12, 5' deoxyadenosyl cobalamin, is a co-factor for methylmalonyl isomerase which converts methylmalonyl CoA to succinyl CoA. In the forward direction this reaction occurs when fatty acids or amino acids are broken down to enter the citric acid cycle. In the reverse direction it is involved in the synthesis of isoleucine and valine. Vitamin B12 is required in Ochromonas malhamensis for this reaction (Wagner 1966).

In E.gracilis a B12 dependent methylmalonyl-CoA mutase controls respiratory utilization of propionyl-CoA. In this organism, vitamin B12 concentration is inversely related to the incorporation of propionic acid into fatty acids (Galli, Lucchini and Bianchetti 1985).

A B12 cofactor, probably methylcobalamin, is required for methionine synthesis in E.coli (Stadtman

1971; Wagner 1966). It is likely that a similar pathway operates in some algae. For example, methionine synthesis is increased by B12 in Prymnesium parvum (Jaenicke 1964) and also in Neochloris pseudoalveolaris (Easley 1969). Isegawa, Nakano and Kitaoka (1984) have suggested that methylcobalamin acts as a co-factor of methionine synthetase on the thylakoids of E.gracilis. Additionally, provision of methionine reduces the B12 requirement of O.malhamensis (Gleason and Hogenkamp 1970), and Barker (1972) has reported a methylated or adenylated cobalamin involved in methionine synthesis in the same organism.

5' deoxyadenosyl cobalamin is required as a co-enzyme for the ribonucleotide reductase reaction in Euglena gracilis (Gleason and Hogenkamp 1970). It functions as an intermediary carrier of hydrogen from the reducing agent to replace a hydroxyl group in the ribose (Stadtman 1971). It is therefore essential for the synthesis of deoxyribonucleotide precursors, which are required for D.N.A synthesis. However, this reaction does not operate in O.malhamensis and O.danica (Gleason and Hogenkamp 1970).

It has been shown that when E.gracilis is deprived of the vitamin, the generation time increases until replication ceases (Epstein, Causely and Bush 1962). In these cells the amount of cellular D.N.A almost doubles while R.N.A and protein synthesis continues (Carell,

Johnston and Christopher 1970 ; Bertaux and Valencia 1972). The cell volume increases up to tenfold (Bertaux and Valencia 1973) and cells contain increased numbers of chloroplasts (Carell 1969).

The most detailed studies on the effects of B12 in E.gracilis have been done by Bre and co-workers. They have shown that both nuclear and cellular divisions are stopped by B12 starvation, and that cell division is arrested in the S/G2 phase (Bre and Lefort-Tran 1978; Bre, Ferjhani and Lefort-Tran 1981). Avitaminosis leads to an inability to perform specific sequential protein syntheses that are necessary for nuclear and cellular division. These specific proteins are required for the transition from S to G2 phase of mitosis. This effect is shown despite the fact that R.N.A and protein synthesis continues as reported above.

However, the effect of B12 starvation can be modified by varying the oxygen and carbon dioxide concentration in the medium (Bre, Diamond and Jacques 1975). This could be due to a change in the pH value, and thus the redox potential within the cell, affecting the equilibrium between reduced and oxidised forms of a participating molecule.

It is evident, therefore, that it is not possible to define one particular effect of B12 on algal cells, or a precise mode of action. It probably has several different functions, not all of which are necessary in any one alga.

## 1.4 VITAMIN B12 UPTAKE MECHANISMS

### 1.4.1 Mammals

Largely due to its importance in human metabolism, where deficiency leads to pernicious anaemia, the mammalian vitamin B12 uptake system has been intensely studied and has some well characterised features. One of the most complete models has been presented by Grasbeck (1979).

There are three types of cobalamin binding proteins in the mammalian system : extracellular, intracellular and membrane-bound. Three extracellular binding proteins have been identified. Intrinsic factor (IF) is the main protein involved in B12 uptake from the intestine, and this has an association constant for cyanocobalamin around  $8 \times 10^9 \text{ M}^{-1}$  (Hippe and Olesen 1971; Allen and Mehlman 1973). It is a glycoprotein with a molecular weight around 50 000, which shows a tendency to form dimers and oligomers when bound to its substrate. This complex has a greater affinity for the IF receptor in the cell membrane than free IF, probably due to the binding of the vitamin causing an allosteric effect on the binding site. The moiety bound to the cobalt atom above the corrin ring has no effect on binding to IF, while few changes are tolerated in the nucleotide side chain. This may suggest that the

cobalamin molecule attaches to its binding site with the nucleotide portion facing inwards.

Cobalophilin (CP) represents a micro-heterogeneous group of glycoproteins. However, its main extracellular function is the transport of cobalamins in body fluids, not uptake. Transcobalamin (TC) is a protein present in much lower quantities than IF, although its properties and functions are almost identical.

The most important membrane-bound protein is IF receptor. This is a high molecular weight glycoprotein consisting of sub-units, either of two types or one type with two conformations, R1 and R2. As mentioned above, it shows a tendency to form oligomers with the cobalamin-IF complex, a process similar to IF dimer formation. This binding of the IF complex to its receptor is necessary for uptake, and requires the interaction of calcium. It is thought that IF is related to its receptor, and derived from it, by gene duplication.

TC also has a membrane-bound receptor protein, and a similar situation exists in terms of structure and function as for IF and its receptor.

The third type of mammalian B12 binders are those proteins which bind the vitamin intracellularly in the cytosol. Less is known about these, although three different proteins have been identified, the most prominent being cobalophilin.

The proposed uptake mechanism is represented in Figure 1.3.

It is suggested that the first stage in cobalamin uptake is its binding to IF, followed by dimerisation. This in turn forms a pseudo-oligomer with the IF receptor in the membrane. This process is energy independent, but does require the presence of calcium. Transport across the membrane occurs either by transfer between the two subunits or is accompanied by the conformational change from R1 to R2 form. It is not yet certain whether this stage requires energy. Intracellular binders accept the vitamin in the cytoplasm, and this may facilitate a diffusion process across the membrane.

Much of the detailed information on this process has been obtained by the isolation and characterisation of the proteins involved using affinity chromatography e.g. Olesen, Hippe and Haber 1971; Marcoulis and Rothenberg 1984. The latter have shown that the IF receptor exists as two species, of molecular weights approximately 350 000 and 700 000, each of which can bind IF. Upon binding a single species of molecular weight 680 000 is found, suggesting that the larger receptor consists of two of the smaller species. This concurs with the suggested dimerisation process.

Hence the main features of the mammalian B12 uptake system are an extracellular protein which pre-



Figure 1.3 The proposed mammalian vitamin B12 uptake system. The extracellular protein IF binds the vitamin and then forms a dimer. This in turn forms a pseudo-oligomer with the related membrane receptor R1. R1 either undergoes a conformational change to R2, or transfers the vitamin to an R2 sub-unit, in either case transporting B12 across the membrane. Intracellular binders such as Cobalophilin [CP] then accept the vitamin in the cytosol.

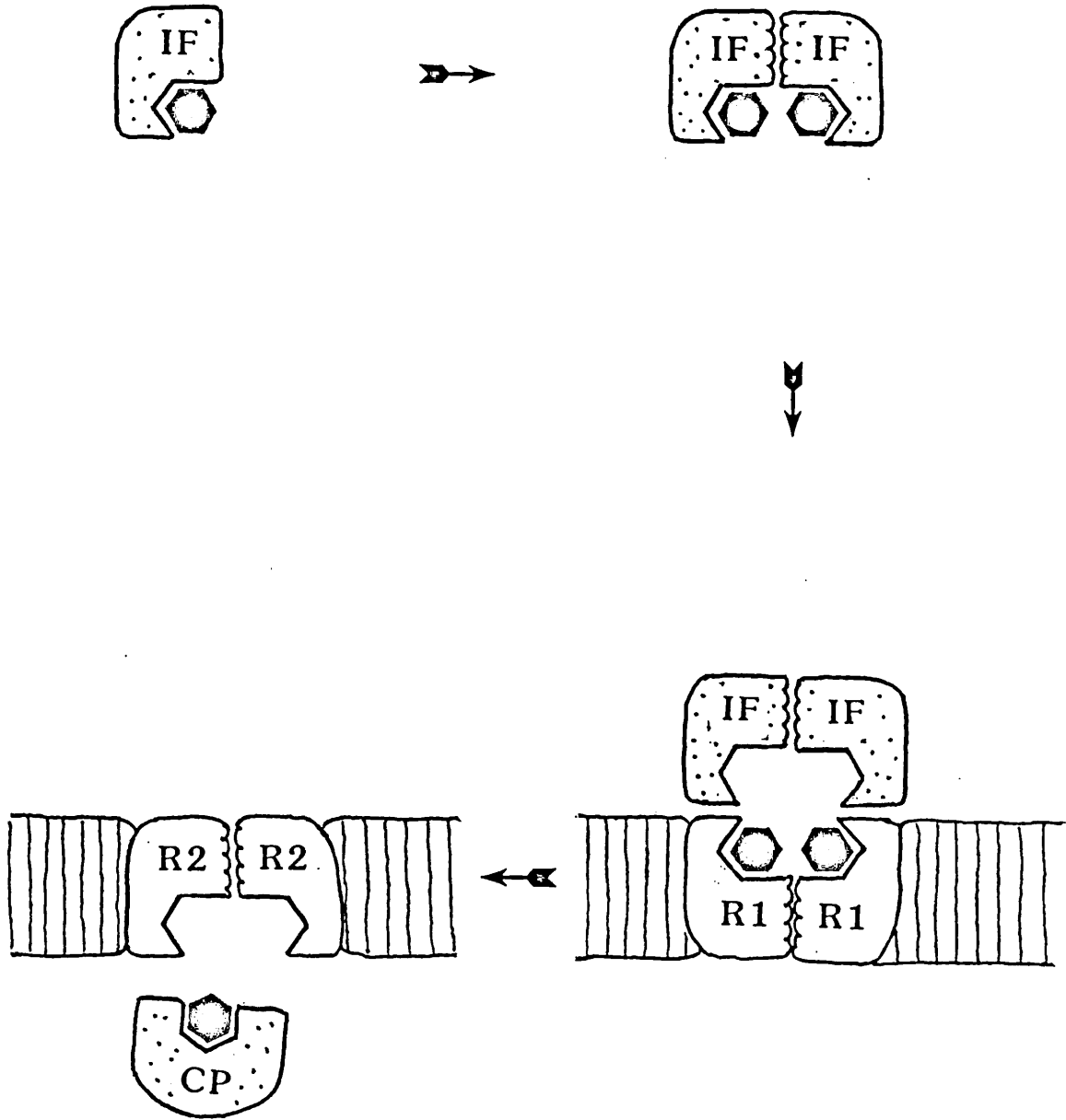

binds the vitamin, followed by dimerisation. This then binds to a related membrane-bound receptor protein which effects transport into the cell.

#### 1.4.2 Bacteria

A considerable amount of research has also been done on the bacterial B12 uptake system. Most of the work has been on the Gram negative bacterium Escherichia coli. The experimental approach has been somewhat different to that used for mammals, and much valuable information has been gathered using genetic mutants unable to produce one or more of the proteins required for uptake. Using the accumulated evidence, Bradbeer (1979) was able to propose two models for the bacterial B12 uptake system, which can be amplified following a recent study (DeVeaux, Clevenson, Bradbeer and Kadner 1986).

As in the mammalian system, more than one cobalamin binding protein is involved, but in E.coli the system is further complicated by the presence of an outer envelope through which the molecule must pass, necessitating two transport systems.

There are four proteins known to be required for cobalamin uptake which are designated [A], [B], [C] and [D] in Figure 1.4. [A] is located in the outer envelope and has a component fragment [a] which is required for

uptake to take place. [B] is located in the inner membrane, separated from [A] by the periplasmic space, as are [C] and [D] which are closely associated. There is also good evidence to suggest that there is a fourth cobalamin binding protein required, which is confined to the periplasmic space, referred to as [P].

B12 uptake in E.coli is biphasic, showing an initial rapid uptake followed by a slower, energy dependent phase of active transport into the cell. Protein [A] acts as an initial receptor for the vitamin and deficient mutants show no uptake at all.

Cells deficient in either the [a] fragment or protein [B] show only the initial rapid binding to receptor [A]. Cells unable to utilize energy from the proton motive force also show initial uptake only. It is therefore concluded that transfer from the receptor protein [A] requires an interaction between [a] and [B], and energy from the proton motive force.

[C-] mutants possess both phases of uptake, but the second phase is diminished and reaches a plateau not seen in wild type cells. A similar but less pronounced effect is shown in [D-] mutants. From this it is concluded that the [C] and [D] proteins are responsible for cobalamin transport across the inner membrane, and that deficient cells accumulate the vitamin in the periplasmic space.

The isolated inner membrane shows no direct

cobalamin binding activity, demonstrating that the vitamin must be bound to a donor molecule, either [P] or [A], before it can bind to [C].

Figures 1.4a and 1.4b show the two proposed models that are consistent with the data. They differ primarily in the presence of a periplasmic binding protein [P], which transfers the vitamin from [A] to [C] across the periplasmic space, as opposed to a direct transfer. It is now most likely that a periplasmic binder is involved (DeVeaux et al. 1986).

Unlike the mammalian system, E.coli will take up factor B showing less specificity, and can therefore utilize the full range of B12 analogues.

Recently, Bradbeer and co-workers have shown that the outer membrane receptor, [A], has a high affinity for cobalamins, with an association constant around  $3.7 \times 10^9 \text{ M}^{-1}$ . However, binding affinity is dependent on the presence of calcium, particularly at higher pH values, and subsaturating concentrations of this ion result in diminished vitamin binding (Bradbeer, Reynolds, Bauler and Fernandez 1986). An analogous situation has already been noted in the mammalian system.

Therefore the main features of bacterial B12 uptake are as follows: an outer membrane receptor binds the vitamin from the medium, but must then interact with an inner membrane protein for further uptake to

Figure 1.4 Two alternative schemes for bacterial B12 uptake. The outer membrane receptor [A] binds the vitamin. An energy dependent interaction between fragment [a] and inner membrane protein [B] then allows vitamin transfer to inner membrane protein [C], either directly (Fig. 1.4a), or via a periplasmic binding protein [P] (Fig. 1.4b). [C] and an associated protein [D] then effect transport into the cell.

Fig. 1.4a

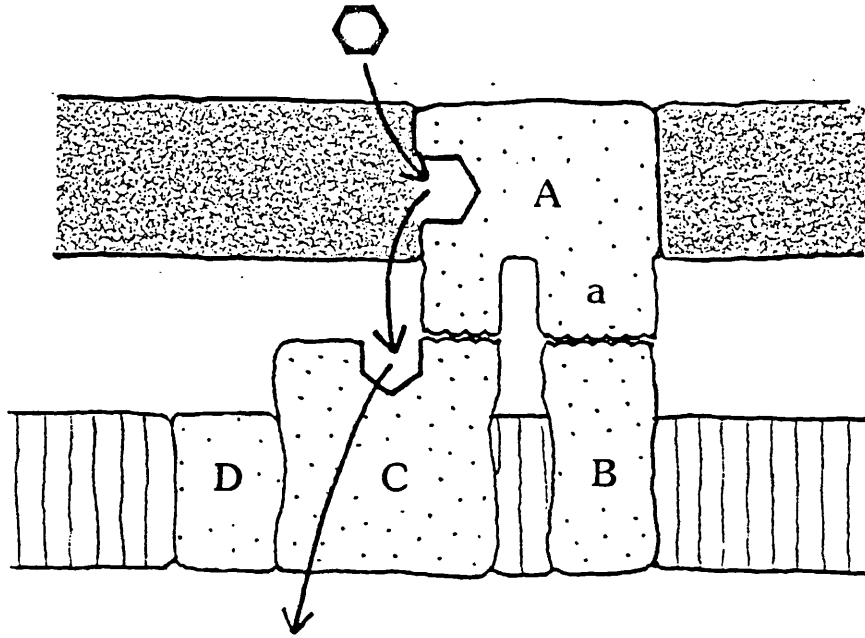
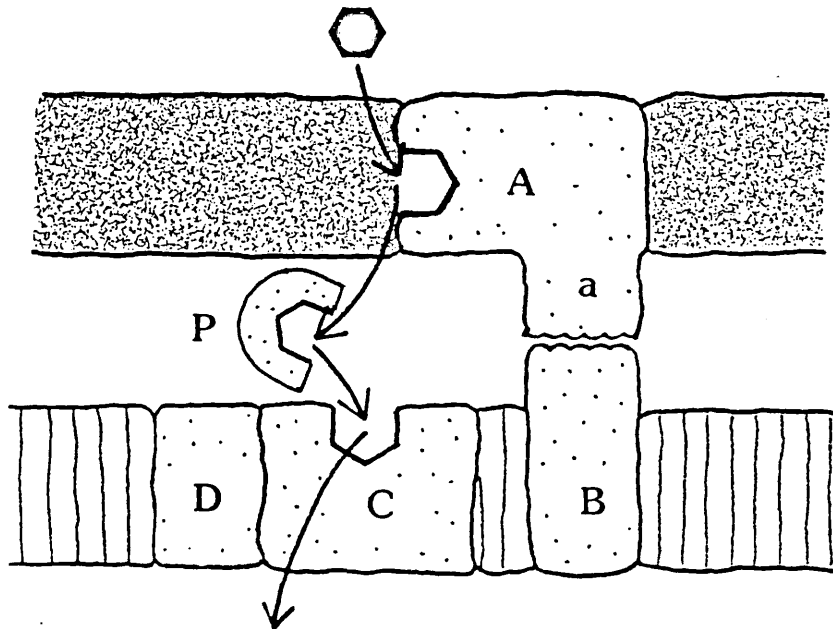

Fig. 1.4b



occur. This allows the transfer of the vitamin to separate inner membrane proteins which effect active transport into the cell. It is apparent that the system is quite complex, although no extracellular binding is involved.

#### 1.4.3 Algae

In contrast to the well characterised bacterial and mammalian systems, less detailed information is available on algal B12 uptake. However, there have been several studies on the B12 binding characteristics of unicells.

As in the mammalian system, three types of algal vitamin B12 binder have been recognized: extracellular, intracellular cytosolic, and, by inference, a membrane-bound binder. An extracellular binding protein (EBP) was first identified in the medium of E.gracilis by Kristensen (1955,1956). Since then many species, from all the major taxonomic groups including both auxotrophs and autotrophs, have been shown to produce a B12 binding factor (Droop 1968; Pintner and Altmeyer 1979; Davies and Leftley 1985).

In all the cases studied, binding activity is lost as a result of autoclaving or treatment with proteolytic enzymes. These binding factors are non-dialysable and render bound B12 unavailable to either



the producing organism or others. The only biochemical characterisation of one of these factors has been by Daisley (1970). He found that E.gracilis EBP was a glycoprotein of molecular weight in excess of 200 000 containing 8-17% reducing sugars, namely xylose and fucose, and hexosamines.

In the same paper, Daisley identified an intracellular binding protein (IBP) showing very similar characteristics to EBP. Cytosolic binding was found in E.gracilis by Varma, Abraham and Hansen (1961) and in O.malhamensis by Reeves and Fay (1966), demonstrating the presence of intracellular binders.

Unidentified membrane-bound binders (MBP) were shown in the cell membrane of E.gracilis by Varma et al. (1961) and inferred in O.malhamensis by Bradbeer (1971). Bound B12 was solubilised from E.gracilis chloroplast membranes by Sarhan, Houde and Cheneval (1980). Thus there is strong indirect evidence for membrane-bound binders.

The kinetics of vitamin B12 uptake by Pavlova (Monochrysis) lutheri were studied by Droop (1968). He found that B12 was rapidly and irreversibly adsorbed onto the cell surface, followed by a much slower steady state uptake into the cell. He suggested that this transport inwards was by diffusion. He also found that the cell surface binding capacity decreased substantially as the cells entered stationary phase.

B12 uptake in O.malhamensis was also found to be biphasic (Reeves and Fay 1966). The first stage of uptake was extremely rapid, less than 1 minute, and like the second, showed saturation kinetics. The secondary phase was much slower, reaching a steady state in 4 hours. This phase was sensitive to the metabolic inhibitors 2,4 dinitrophenol and sodium fluoride. Uptake showed pH dependence with a sharp decrease above 6.5, due to an effect on the initial stage. An effect of calcium ions, the presence of which stimulated uptake at higher pH, was also observed. Addition of the analogue anilide-B12 reduced cyanocobalamin uptake, showing that it competed for the same uptake mechanism.

Bradbeer (1971) confirmed these results and also showed that the secondary phase was temperature dependent with a marked optimum at 34°C. Less than 10% of the B12 bound is exchangeable with the medium. Methyl-, aqua- and deoxyadenosyl- cobalamins were all shown to be taken up at similar rates to cyanocobalamin, but uptake of factor B was negligible.

Bunt (1970), working on marine macro-algae, showed almost steady state B12 uptake over a 4 hour period in several species. No samples were taken after short incubation periods however. It was not possible to differentiate between a facilitated diffusion process and active biological transport, although no work was

done with metabolic inhibitors.

Euglena gracilis B12 uptake was studied by Varma et al. (1961) and showed saturation kinetics. It was pH and temperature dependent with optima at 3.7 and 32°C respectively. Intracellular cobalamins were identified as being bound to particulate fractions, but not to the chloroplasts. Labelled B12 was not lost from intact cells, but when bound to cell membrane fragments was exchangeable with vitamin in the medium.

Biphasic uptake in E.gracilis was shown by Sarhan et al. (1980). The first stage was rapid, reaching a plateau in five minutes, while the secondary phase continued for at least four hours. Both stages were sensitive to pH variation, but the second also showed a high degree of temperature dependence with a sharp optimum at 30°C. This phase was completely inhibited by 2,4 dinitrophenol, potassium cyanide and sodium azide suggesting it was energy dependent. Bound B12 was inexchangeable; thus accumulation is irreversible. It was also found, in contrast to the results of Varma et al. (1961), that at least 60% of B12 was associated with the chloroplasts. These organelles showed uptake kinetics similar to whole cells, but were unaffected by inhibitors. This led to the suggestion by Sarhan et al. that chloroplasts are the main B12 binding site, and may regulate cell uptake.

Also working on E.gracilis, Isegawa et al. (1984)

showed that cyanocobalamin taken up by cells is converted to coenzyme forms within 30 minutes. These cobalamins were shown to be bound to all sub-cellular fractions, but the chloroplast binding accounted for only 21% of the total. 80% of cobalamin incorporated into the chloroplasts was located on the thylakoids, while only 15% was associated with the envelope. This suggests that the chloroplast is not a major B12 binding site.

The auxotrophic diatom Thalassiosira pseudonana shows substrate saturable B12 uptake (Herold and Sullivan 1980). The process is pH, temperature and light dependent, and can be suppressed by metabolic inhibitors. There is no loss of B12 to vitamin-free medium, but some exchange takes place between bound vitamin and that in the medium. Uptake is competitively inhibited both by B12 analogues which support growth and some which do not.

It is apparent from the results of Reeves and Fay (1966) already mentioned that the presence of B12 analogues can reduce cyanocobalamin binding. Factor B, which can be utilized for growth by Skeletonema costatum and Agmenellum quadruplicatum, competitively inhibits cyanocobalamin uptake in these organisms. However, it has no effect on uptake by P.lutheri which cannot utilize it (Leftley pers. comm.). The inactive analogues pseudovitamin B12 and factor A competitively

inhibit cyanocobalmin binding in O.malhamensis (Ford 1958). This correlates with the results of Bradbeer (1971) who showed additionally that factor B was not taken up.

It may therefore be suggested that there is a single type of B12 binding site in each organism, for which different analogues compete. However, it appears that there are differences in specificity between organisms, although these are not necessarily related to their ability to utilize the various analogues.

Most recently association constants for the extracellular B12 binding proteins from a range of algae have been determined by Davies and Leftley (1985). These binders have extremely high affinities for the vitamin, with  $K_a$  values ranging from  $3.3 \times 10^{10}$  to  $5.8 \times 10^{11} \text{ M}^{-1}$ . These are even higher than that of mammalian intrinsic factor.

In no case has an extracellular B12 binding protein been found to be necessary for cellular uptake. Moreover, it has been shown that EBP actually reduces uptake by binding free vitamin, thus rendering it unavailable (Kristensen 1955, 1956; Droop 1968). It would seem highly probable therefore that EBP plays no part in cellular B12 uptake.

There appears to be a general picture of biphasic B12 uptake by unicellular algae. The first phase is extremely rapid and relatively insensitive to modifying

factors. The secondary phase proceeds at around 2% of the initial rate and is energy dependent, being blocked by metabolic inhibitors. It is also sensitive to environmental factors, especially temperature.

A relatively simple model can therefore be suggested for micro-algal B12 uptake. The first stage represents the rapid binding of the vitamin to a B12 receptor in the cell membrane. In this state the bound vitamin has a limited ability to exchange with free substrate in the medium.

This binding facilitates a transport process across the membrane in an energy dependent step, rendering the vitamin inexchangeable. Clearly however, only an outline picture of algal B12 uptake is possible, and the detailed nature of the process is not yet understood.

In particular, there are several important features of the binding and uptake of this vitamin by algae which are so far unknown :

- 1) The nature of the cell membrane transport system, and how many proteins are involved.

- 2) The fate of the vitamin once it enters the cell, particularly the role of cytosolic binding proteins, and whether there is one organelle principally responsible for intracellular binding.

- 3) The function and origin of extracellular B12 binders, and whether there is any relationship to cellular binding proteins.

### 1.5 STRUCTURE AND CHARACTERISTICS OF THE ALGAE

To enable as much information as possible on algal vitamin B12 binding to be obtained, representatives of both B12 auxotrophic and autotrophic species were chosen for study. A number of features were considered desirable when selecting the organisms:

- 1) Established production of large amounts of B12 binding protein.
- 2) Availability in axenic culture.
- 3) A close phylogenetic relationship.

Consideration of the third point would have allowed the study of any differences attributable to nutrient requirement status. Although not all three criteria could be satisfied, the two naked, unicellular marine flagellates D.primolecta and P.lutheri, each of which possess a single large chloroplast, were readily available. These fulfilled the important requirements 1) and 2), and were adopted for study, allowing the investigation of whether the mechanisms operating were similar in a wider range of algae.

Pavlova (formerly Monochrysis) lutheri (Droop) is an auxotroph requiring cyanocobalamin and thiamine (Droop 1958). It shows type L specificity towards B12, utilizing all analogues with a side chain, but not

factor B (Droop, McLaughlin, Pintner and Provasoli 1959). It is a member of the Haptophyceae, and therefore shows similar pigmentation to the golden brown Chrysophyceae in which it was formerly placed. It is a marine species preferring a brackish environment. Its structure has been elucidated by Green (1975, 1980).

It is broadly ovate to rhombic in shape, and concavo-convex in lateral view. Cell dimensions are within the range 7-9 x 5-7 x 3-4  $\mu\text{m}$ . Two unequal flagella and a haptonema, which is covered in knob scales, arise close together from the middle of the ventral surface. There is a single bilobed yellow-green chloroplast, but no pyrenoid is present. A pale stigma (eye spot) is located under the short flagellum, and the nucleus is situated at the anterior end of the cell.

Although cells are naked with no cellulose wall present, a periplast is visible under the electron microscope. This consists of the plasmalemma and cisternae of the endoplasmic reticulum sandwiching a thin layer of cytoplasm. It forms a continuous layer around the periphery of the cell except at the site where the flagella emerge, and frequently becomes detached during fixation (Veer 1979, Green 1980).

Cells are always motile and proceed with the long anterior flagellum directed forwards, beating in an S-



shaped wave action. The posterior flagellum is directed backwards and beats with a stiff jerky action. This normally causes cells to spin rapidly about the longitudinal axis while swimming. Reproduction is by longitudinal division whilst in the motile phase, and sexual reproduction is unknown.

Dunaliella primolecta (Butcher) is a unicellular autotrophic Chlorophyte, and hence shows no absolute requirement for any exogenous vitamin supply. It is a marine species showing marked halotolerance. Information on its structure comes from light and electron microscope studies by Eyden (1975), and from Hoshaw and Maluf (1981).

In logarithmic phase cells are ovoid, measuring 10 x 7  $\mu\text{m}$ . In stationary phase they are 10  $\mu\text{m}$  diameter spheres. Two equal flagella are anteriorally inserted. As in P.lutheri there is no cell wall, but there is sometimes an amorphous layer of variable thickness and distribution. This cell coat has been shown in the closely related species D.tertiolecta to have a large glycoprotein component (Klut, Bisalputra and Antia 1983).

Internally the cell is dominated by a large cup-shaped chloroplast. The pyrenoid is penetrated by thylakoids and a stigma is also situated within the chloroplast envelope at the anterior end. Starch granules are clearly visible, but are more prominent in

the stationary phase. The nucleus is roughly central in the cell, and in logarithmic phase clear vacuoles are present. It has been suggested (Eyden 1975) that the golgi apparatus located above the nucleus may secrete the cell coat materials.

A whole cell of D.primolecta is shown in Plate 6.2 (Chapter 6).

## 1.6 VITAMIN B12 AND ALGAL ECOLOGY

### 1.6.1 Vitamin B12 concentration in natural waters and its determinants

Algae which are autotrophic are capable of synthesising vitamins at rates in step with cell division (Provasoli and Carlucci 1974). However, for B12 auxotrophs and those facultative autotrophs stimulated by the vitamin, cyanocobalamin will be a growth-regulating factor. Therefore the availability of this vitamin under natural conditions may be of some significance in algal ecology.

The concentration of B12 in natural waters is highly variable, depending on both locality and season. In the Pacific, concentrations vary between averages of 0.1 ng l<sup>-1</sup> in the open ocean to 2.9 ng l<sup>-1</sup> in coastal regions (Carlucci 1970). These values are

typical for seawaters (Provasoli and Carlucci 1974), but values as low as  $0.01 \text{ ng l}^{-1}$  and undetectable have been recorded (Menzel and Spaeth 1962). Open ocean waters generally show the lowest concentrations, while intermediate depths show the highest levels of vitamins (Daisley and Fisher 1958). In the upper waters, which are most involved in biological activities, levels fluctuate during the year. However, the pattern of seasonal variation differs between locations, thereby precluding the description of a general pattern (Swift 1980).

Freshwater B12 concentrations also vary with location and season from undetectable to  $62.5 \text{ ng l}^{-1}$  (Swift 1980). Daisley (1969) found low B12 levels ( $0.1 \text{ ng l}^{-1}$ ) in oligotrophic lakes and high levels ( $15 \text{ ng l}^{-1}$ ) in eutrophic lakes. This pattern of low levels in oligotrophic lakes and high levels in eutrophic lakes was also reported by Kim, Park, Jeon and Kong (1986), with values ranging from  $0.3$  to  $11.9 \text{ ng l}^{-1}$ .

River water has been found to contain between 2 and  $11 \text{ ng l}^{-1}$  B12, while treated wastewater inputs varied between 6 and  $42 \text{ ng l}^{-1}$  (Furuki, Kubo, Moriguchi and Kitamara 1984).

Estuarine waters at Long Island Sound, New York showed seasonal variations in B12 levels, with the highest peaks recorded between June and September. The concentration of B12 itself varied from undetectable

(less than  $0.05 \text{ ng l}^{-1}$ ) to  $14.3 \text{ ng l}^{-1}$ , with a mean value of  $2.2 \text{ ng l}^{-1}$ . Additionally, the concentration of other analogues varied between undetectable and  $29.4 \text{ ng l}^{-1}$ , mean value  $3.3 \text{ ng l}^{-1}$  (Bruno, Staker and Curtis 1981).

It should be noted that these levels are all in the same range as the limiting concentrations of B12 for algae as reported in section 1.1.

There are two main groups of vitamin-producing organisms in natural waters. Carlucci and Bowes (1970a) showed that several ecologically important phytoplankton species released vitamins into the medium. They have also shown that vitamins excreted by these autotrophs can support the growth of vitamin-requiring algae grown in the same vessel, a phenomenon known as syntrophic growth (1970b). However, not all autotrophs secrete vitamins in this way. Maximum release of vitamins takes place during stationary phase when cell lysis begins to occur, but excretion also occurs during logarithmic growth (Carlucci and Bowes 1970a).

Bacteria are the principal group of aquatic vitamin producers, and it has been shown that algae can utilize the B12 released (Haines and Guillard 1974). In some cases a symbiotic relationship can be formed. For example, Chattonella antiqua receives required B12, while the producing bacteria utilize excreted glycolate

(Furuki and Kubo 1984). However, B12 production by these organisms is somewhat different since many bacteria are known to produce B12 analogues which not all algae can necessarily utilize. Available B12 derivatives in seawater have been found to include methyl-, aqua- and 5'deoxyadenosyl- cobalamins (Furuki et al. 1984).

There are several other factors in the study of B12 ecology which should be taken into account. Firstly, the vitamin content of sediments and suspended material is a substantial component of the total (Burkholder and Burkholder 1956). White and Wetzel (1985) showed that approximately 10% of B12 added to "hard" lake water containing calcium carbonate became absorbed and precipitated with this compound. Furuki et al. (1984) found that the concentration of B12 in sea-bottom sediments was around 50 times that in the waters of the Sea of Harima, Japan, where typical levels varied between undetectable and 20 ng l<sup>-1</sup>. Thus there are considerable natural reserves of B12, and mixing of water levels in any aquatic system provides a source of vitamins, as does drainage or input into a lake from tributaries.

Secondly, the transfer of vitamin B12 between trophic levels has been shown by Droop and Scott (1978). In an algal-herbivore system with a marine rotifer grazing on a green alga, 60 % of the B12

present in the alga was incorporated into the herbivore. 25 % was released as soluble B12, making it available to other organisms, and 15 % remained in ungrazed algae.

Degradation by solar radiation and physiochemical destruction is also known to occur (Carlucci, Silbernagel and McNally 1969). Therefore, the available vitamin concentration in any particular situation is determined by the balance between many producing and consuming processes. The dominant processes almost certainly vary during the year, accounting for seasonal variations.

A further complicating element is the production of extracellular B12 binding factors by algae which will be discussed later.

#### 1.6.2 Ecological implications

There have been a number of studies attempting to elucidate the possible ecological role of vitamin B12 under natural conditions, but in many cases it has not been possible to draw firm conclusions due to the complexities of the vitamin's cycle. However, there is good evidence to show that B12 can act as a growth controlling nutrient.

For example, Wetzel (1965, 1966) showed that the addition of B12 to hardwater lakes could result in

significant increases, typically up to 50%, in the rate of carbon fixation and primary productivity. More recently, of three red tide causing flagellates, cyanocobalamin was found to be an important growth-promoting secondary nutrient for Eutreptiella sp. Without sufficient addition of this vitamin, increased yields due to nitrogen and phosphorous could not be supported (Yamochi 1984).

In a detailed study of the growth potential of artificially enriched phytoplankton samples from Cabo Frio seawater, Brazil, nitrogen was found to be the primary limiting factor. Neither this, nor phosphorous, altered the species' composition when added. However, the addition of EDTA and vitamins, including B12, was required to achieve maximum yields. This dramatically reduced the number of species and the pattern of dominance.

Turning to specific investigations to evaluate the ecological role of the vitamin in particular environments, a moderate diatom bloom was observed in the Sargasso Sea when B12 concentrations were highest. As the B12 level fell to barely detectable, the diatom population decreased. However, it was not thought that vitamin B12 limited primary productivity, but that it may well have influenced the composition of the phytoplankton (Menzel and Spaeth 1962).

Working in Pacific coastal waters off California,

Carlucci (1970) found no conclusive evidence that total phytoplankton productivity was limited by vitamins, although some positive correlations were found. B12 concentrations dropped sharply when the red tide causing dinoflagellate Gonyaulax polyedra became dominant, and an effect on individual species was not precluded.

Fiala and Oriol (1984) found a positive correlation between vitamin concentration and phytoplankton density in the Antarctic Ocean. This was thought to be due to the stimulation of diatom growth by vitamin B12. A similar effect was observed in a detailed study of the Gulf of Maine by Swift (1981). She reported stimulation of the spring diatom bloom by B12.

In Lake Sagami, Japan, there was an increase in vitamin B12 during the growth of Anacystis cyanea. However, when diatom species became dominant, there was a decrease in B12 concentration (Ohwada and Taga 1972).

Therefore there is good evidence to show that changes occur in the biological properties of waters during algal blooms i.e. the removal of vitamins required and / or the release of other vitamins. This could condition the water to favour the subsequent growth of particular algae, and may be one of the factors operating in the seasonal succession of algal species (Provasoli 1971).



The first dominant species in the seasonal succession are frequently diatoms, many of which require vitamin B12 or are stimulated by it. These will remove the initially high concentrations of B12. However, as the bloom reaches an end, cell lysis may release vitamins from cells. Thus the various vitamin concentrations may be quite different from those preceding the bloom, which again suggests that the species which follow may be influenced (Swift 1980).

The somewhat enigmatic production of extracellular B12 binding factor has already been mentioned. Maximum release of these binders occurs as the stationary phase is entered (Pintner and Altmeyer 1979), while 90 % of available B12 is taken up during the first third of the logarithmic phase (Droop 1968). The binder therefore probably only affects the latter stages of growth, or subsequent species. However, its significance is unclear.

Messina and Baker (1982) showed that the growth of a B12-requiring species, Skeletonema costatum, could be competitively inhibited by B12 binders from other algae. This occurs at vitamin concentrations and cell densities possible in natural waters, and therefore B12 binding factors may have an effect on species' succession. The observed inhibition of C.antiqua by other algae (Furuki and Kubo 1984) could have been due to this species being starved of B12 by extracellular

binders.

Provasoli (1971) has suggested that the release of B12 binders may allow the initially dominant species to maintain its population longer by making B12 unavailable to auxotrophs. Another ecological effect may be to slow down growth rates, and preserve some B12 in unbound form (Provasoli and Carlucci 1974). Whether this bound B12 can act as a reserve of B12 will depend on the relative rates of degradation of the binding complex by micro-organisms, and physio-chemical destruction of the vitamin.

### 1.6.3 Conclusion

By means of their uptake mechanisms, both auxotrophs and autotrophs can accumulate B12, if available, far in excess of (600 to 1000 times) their minimum requirement (Bradbeer 1971 ; Sarhan et al. 1980). This amount of stored B12 would permit growth for 10 subsequent generations in the absence of available B12. In addition, extracellular B12 binding factor can clearly influence the amount of available vitamin.

It would appear that vitamin B12 can almost certainly influence species succession, and may even affect total algal productivity. In this case, B12 uptake and binding is of considerable potential importance in aquatic systems.

CHAPTER 2 - THE DEVELOPMENT OF CULTURING AND  
B12 BINDING ASSAY METHODOLOGY.

INTRODUCTION

A prerequisite for this study of B12 binding and uptake by unicellular algae was the optimisation of suitable culturing techniques to maximize yields of the two algae being employed, and hence produce sufficient quantities of the B12 binders for study.

Also, although procedures for assaying B12 binding by unicells are well documented, for example Reeves and Fay 1966 ; Bradbeer 1971, it was necessary to find an efficient method for assaying soluble B12 binding activity. Pintner and Altmeyer (1979) had previously used a method of inhibition neutralisation (the amount of added cyanocobalamin necessary to overcome the inhibition of growth of a B12 auxotroph by soluble B12 binders) to study extracellular binding. Gel filtration has been used to separate free and bound B12 (Daisley 1961). However, neither of these methods was considered practical for the necessary accurate and rapid determination of B12 binding.

Recently, the work of Davies and Leftley (1985) describes the use of an ultrafiltration method for the separation of free from extracellular bound vitamin. A

similar technique for assaying soluble algal B12 binding, and suitable culturing methods, for use in later detailed studies were therefore developed.

#### MATERIALS AND METHODS

Algal culturing.

Cultures of D.primolecta (SMBA strain number 57  $\equiv$  CCAP 11/34) and P.lutheri (SMBA strain number 261), were obtained from the culture collection of the Scottish Marine Biological Association.

Initially, both species were cultured axenically in static 100 ml and 250 ml conical flasks, with occasional mixing, in the ASP2 medium of Provasoli, McLaughlin and Droop (1957). After the trials of illumination and medium composition detailed under results, a modified version of this medium, the composition of which is given in Table 2.1, was used. The vitamin mix was only added to cultures of P.lutheri.

Illumination was normally maintained at a constant  $72 \mu\text{E m}^{-2} \text{s}^{-1}$  ( $\equiv 33 \mu\text{E m}^{-2} \text{s}^{-1}$  PAR) from white and warm-white fluorescent tubes. The temperature was kept at  $18.5^\circ\text{C} \pm 1.5^\circ\text{C}$ . For large scale cultivation, 5 litres of medium in a 10 litre Pyrex bottle was gently

<u>COMPOUND</u>	<u>CONCENTRATION IN MEDIUM (g l<sup>-1</sup>)</u>	
Na Cl	18.0	
Mg SO <sub>4</sub> .7H <sub>2</sub> O	5.0	
K Cl	6.0 x 10 <sup>-1</sup>	
Ca Cl <sub>2</sub>	1.0 x 10 <sup>-1</sup>	
K NO <sub>3</sub>	1.0	
K <sub>2</sub> HPO <sub>4</sub>	2.5 x 10 <sup>-2</sup>	
Na <sub>2</sub> EDTA	3.0 x 10 <sup>-2</sup>	
Tricine	1.0	
Fe Cl <sub>3</sub>	2.3 x 10 <sup>-3</sup>	} Pl Metals
H <sub>3</sub> BO <sub>3</sub>	3.4 x 10 <sup>-3</sup>	
Mn Cl <sub>2</sub> .4H <sub>2</sub> O	4.3 x 10 <sup>-4</sup>	
Zn SO <sub>4</sub> .7H <sub>2</sub> O	6.7 x 10 <sup>-4</sup>	
Na <sub>2</sub> MoO <sub>4</sub> .2H <sub>2</sub> O	3.0 x 10 <sup>-6</sup>	
Co Cl <sub>2</sub> .6H <sub>2</sub> O	1.2 x 10 <sup>-6</sup>	
Cu SO <sub>4</sub> .5H <sub>2</sub> O	3.0 x 10 <sup>-7</sup>	} Vitamin mix <u>P.lutheri</u> only.
Cyanocobalamin	7.5 x 10 <sup>-8</sup>	
Thiamine	2.5 x 10 <sup>-5</sup>	
Biotin	5.0 x 10 <sup>-6</sup>	

Table 2.1 The composition of the modified ASP2 medium, buffered to pH 7.6 with 0.1 M NaOH.

<u>CHEMICAL</u>	<u>AMOUNT PER LITRE</u>
Napthalene	60 g
P.P.O	4 g
P.O.P.O.P	0.2 g
Methanol	100 ml
p-dioxane	up to 1 litre

Table 2.2 The composition of Bray's scintillant.

aerated with 0.5% CO<sub>2</sub> enriched air. This was humidified and filter-sterilised by passing through a primary 1 µm glass micro-fibre filter (Gamma 12-10, Whatman), a Dreschel bottle containing sterile H<sub>2</sub>O and a Millex FG50 unit containing a 0.2 µm PTFE filter, prior to inflow.

Sterility tests were performed at regular intervals on stocks, and before harvesting experimental cultures. 0.1 ml of medium was incubated at 37°C on 1.5% agar/ASP2, enriched with 1.5% glucose and 0.5% peptone. After 24 hours, plates were observed for the presence of colonies. Microscopic examination was also used to confirm sterility.

Accurate determinations of cell density were made by haemocytometric counts. A calibration graph of absorbance at 675 nm, measured on an LKB Ultrospec spectrophotometer, against cell density was constructed and commonly used to estimate cell numbers.

#### Assay of soluble B12 binding.

The principle used was to add a quantity of the radionuclide <sup>57</sup>Co B12 (type CT2 Amersham International) to medium containing soluble binding protein, followed by separation and counting of free and bound radioactive vitamin. Medium was first pre-filtered through a Whatman GF/A glass microfibre filter which

removed larger particles and most cells, and a 0.2  $\mu\text{m}$  cellulose nitrate membrane filter to remove any remaining cells and culture debris. 0.1 ml of  $^{57}\text{Co}$  B12 solution containing 0.454 ng of vitamin was then incubated at 23°C for 1 hour with 1 ml of the medium. An Amicon Micro Partition System (MPS) ultrafiltration unit with a YMT membrane was used to separate free and bound B12. (This is shown in Figure 2.1). 0.8 ml of solution was ultrafiltered at 23°C under centrifugation at 700g for 4 minutes. Assays were performed at least in duplicate.

Initially, counting of  $^{57}\text{Co}$  B12, a gamma emitter, was by the mini-vial method of Helman and Ting (1973), in a Beckman LS232 liquid scintillation counter. Counting efficiency in  $\text{H}_2\text{O}$  and ASP2 medium was investigated using two scintillants: Brays (composition given in Table 2.2) and cocktail "W" (BDH chemicals). These trials, details of which are given under Results, determined the adoption of Brays scintillant as the standard. When an LKB Mini-Gamma counter became available, this was used by counting 0.2 ml of radioactive solution in stoppered polycarbonate vials.

The efficiency of the MPS method for separating B12 was determined in two ways. Firstly, the possibility of non-specific binding was investigated by adding  $^{57}\text{Co}$  B12 to sterile, 0.2  $\mu\text{m}$  filtered ASP2 medium, which was then ultrafiltered through the MPS

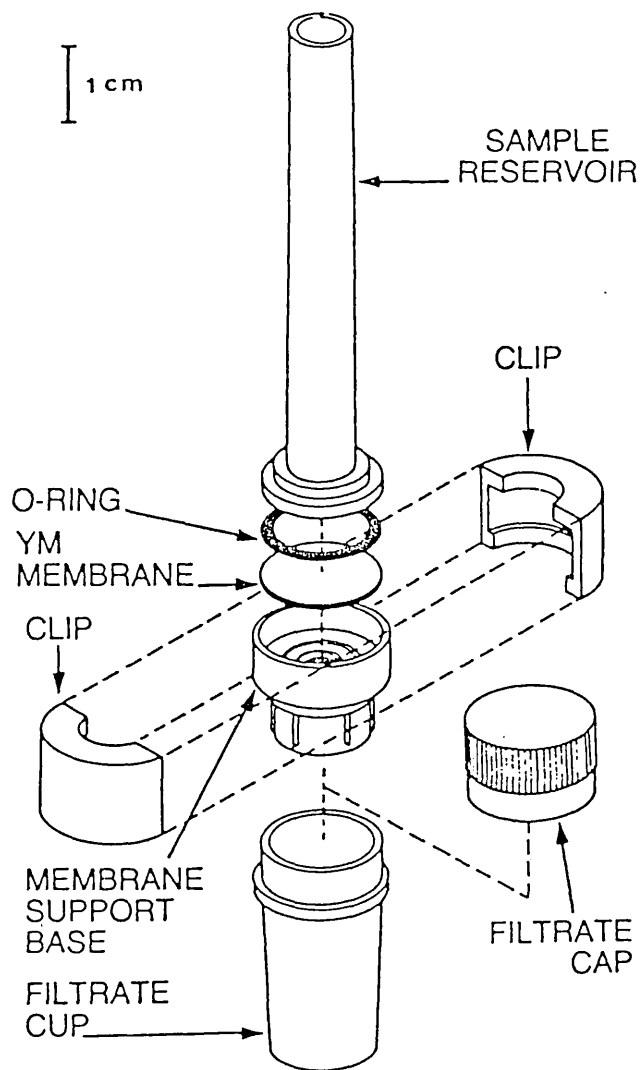

Figure 2.1 The Amicon micro partition system (MPS-1 unit) used to separate free and bound vitamin B12.



unit before counting. Secondly, the efficiency of free and bound B12 separation was investigated. 0.454 ng of radioactive vitamin was incubated with 1 ml of a solution of hog non-intrinsic factor (Sigma) with a B12 binding capacity of 0.250 ng for 1 hour, followed by MPS separation. The B12 present in the ultrafiltrate was then counted.

Parameters which might affect the assay were investigated using filtered D.primolecta medium containing extracellular binding protein. Firstly, the effect of the volume of medium ultrafiltered on free B12 recovery was determined by varying the centrifugation time of 1 ml of the original incubation mixture to obtain between 0.2 and 0.8 ml ultrafiltrate.

Secondly, binding capacity was assayed after incubation periods ranging from 20 to 120 minutes to investigate any possible time dependence effect.

Finally, the filtered medium of D.primolecta and P.lutheri cultures in stationary phase was diluted by varying factors with sterile medium before assay. This increased the ratio of  $^{57}\text{Co}$  B12 to extracellular binding protein, and enabled the dilution factor ensuring saturation of the binders present to be determined.

## RESULTS

### Algal culturing.

The calibration graph obtained for absorbance at 675 nm against cell density as estimated by haemocytometric counting is shown in Figure 2.2. A linear relationship was found over the range investigated, up to  $10^7$  cells  $\text{ml}^{-1}$ , and this method was frequently used for the rapid determination of cell numbers.

The effects of variations in the total level of illumination, and the nitrogen and phosphorous content of the ASP2 medium on the growth of 250 ml cultures of D.primolecta cultures are given in Table 2.3. As a result of these trials, the modified ASP2 medium of Table 2.1, containing 10 times the standard nitrogen content and 5 times phosphorous, was used. This gave a maximum yield of  $9.21 \times 10^6$  cells  $\text{ml}^{-1}$ . Increasing the concentration of the phosphorous compound further resulted in unacceptable levels of precipitation in the medium.

Illumination above  $72 \mu\text{E m}^{-2}\text{s}^{-1}$  resulted in the initial more rapid growth of the culture, but no increase in final yield, and in premature ageing of the culture. When cultivation was scaled up to 5 litre batches, the yield of static cultures was only  $1.09 \times$

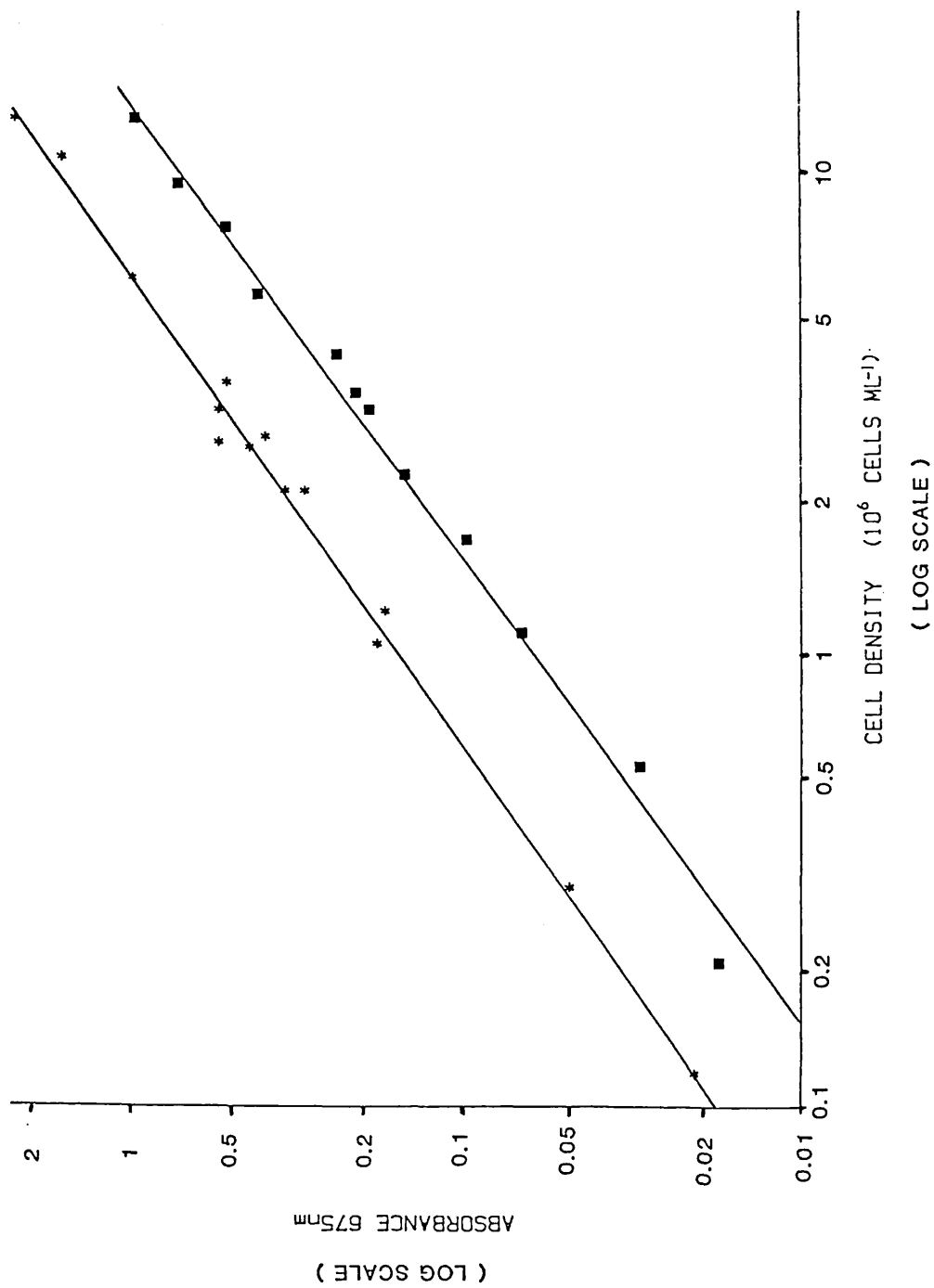

Figure 2.2 Absorbance measured at 675 nm against cell density of *D. primolecta* ( \* ) and *P. lutheri* ( ■ ) cultures.

CONDITIONS		MAXIMUM DENSITY	APPROXIMATE TIME TO MAX. DENSITY
ASP2	ILLUMINATION		
Original	72 $\mu\text{E m}^{-2} \text{s}^{-1}$	3.04 x 10 <sup>6</sup>	25 Days
Original	48 $\mu\text{E m}^{-2} \text{s}^{-1}$	2.95 x 10 <sup>6</sup>	32 Days
Original	273 $\mu\text{E m}^{-2} \text{s}^{-1}$	3.02 x 10 <sup>6</sup>	18 Days
2 x N+P	72 $\mu\text{E m}^{-2} \text{s}^{-1}$	5.28 x 10 <sup>6</sup>	29 Days
5 x N+P	72 $\mu\text{E m}^{-2} \text{s}^{-1}$	8.70 x 10 <sup>6</sup>	32 Days

Table 2.3 The effect of variations in the composition of ASP2 growth medium and total illumination, on the final yield and time taken to reach maximum density of D.primolecta cultures.

$10^6$  cells  $\text{ml}^{-1}$ . These cultures were therefore gently aerated, increasing the average maximum yield to  $5.11 \times 10^6$  cells  $\text{ml}^{-1}$ .

To minimize the amount of extracellular B12 binding protein becoming complexed to the vitamin, the B12 concentration in the medium was reduced. Initially  $30 \text{ ng l}^{-1}$ , as used by Pintner and Altmeyer (1979), was adopted for P.lutheri cultures only. However, a decrease in cell density became apparent. Therefore, a level of  $75 \text{ ng l}^{-1}$  was tested, and subsequently used successfully.

B12 binding assay.

The efficiencies of the different  $^{57}\text{Co}$  B12 counting systems used are shown in Figure 2.3. The gamma counter has the highest efficiency, 86% , and was also found to be completely linear up to  $2 \times 10^6$  cpm. Liquid scintillation counting shows a marked quenching effect dependent on the composition of the medium, and starts to become non-linear above approximately  $10^6$  cpm. Clearly, the direct gamma counting method was preferable.

It was demonstrated that 99.4% of B12 dissolved in sterile ASP2 medium, then filtered through the MPS system, was recovered in the ultra-filtrate (Table 2.4). Using hog non-intrinsic factor to bind

approximately half of the B12 in solution, 97.8% of the expected free B12 (44.9 % of the total) was recovered after separation (Table 2.4).

It was therefore concluded that there was negligible non-specific binding of B12 by the apparatus, and also that it was suitable for separating free and bound vitamin.

It was found that neither the volume of medium ultrafiltered (Figure 2.4), nor the length of the incubation period of B12 with binding protein solution (Figure 2.5), affected the estimated B12 binding capacity. These were standardised at 0.5 ml and 1 hour respectively.

Figure 2.6 shows the saturation curves obtained for increasing ratios of  $^{57}\text{CoB12}$  to binding proteins of D.primolecta and P.lutheri. A 1 in 20 dilution (5% of the original concentration) of the binding proteins appears to effectively saturate the binding capacity.

However, at the highest ratio, namely a 1 in 20 (5%) dilution, variation in the estimated binding capacity increased noticeably in comparison to lower dilution factors. (See Table 2.5). It was therefore decided to use a standard dilution of 1 in 10 for soluble B12 binding assay.

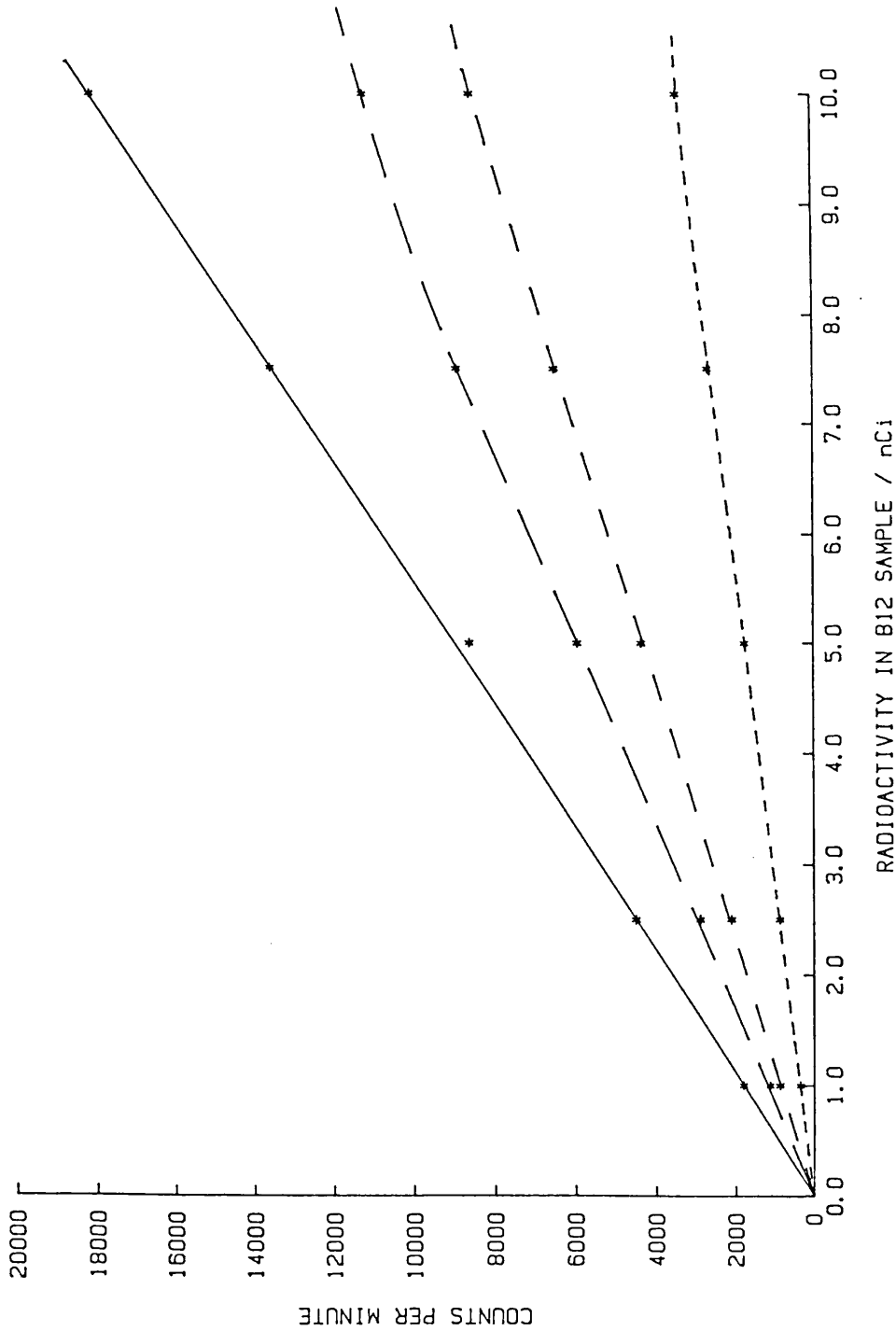

Figure 2.3 The counting efficiency of <sup>57</sup>Co B12 in different radioactivity counting systems.  
( ——— Gamma counter, - - - - - Bray's in H<sub>2</sub>O, - - - - - BDH "W" in ASP2, - . - . - Bray's in ASP2).

SAMPLE ULTRAFILTERED	TOTAL B12 cpm	FREE B12 cpm	% B12 IN ULTRAFILTRATE	
			ACTUAL	EXPECTED
Sterile ASP2 medium	8341	8289	99.4	100.0
Hog non-intrinsic factor solution.	8295	3645	43.5	44.9

Table 2.4 The efficiency of the MPS ultrafiltration system for separating free and bound B12.



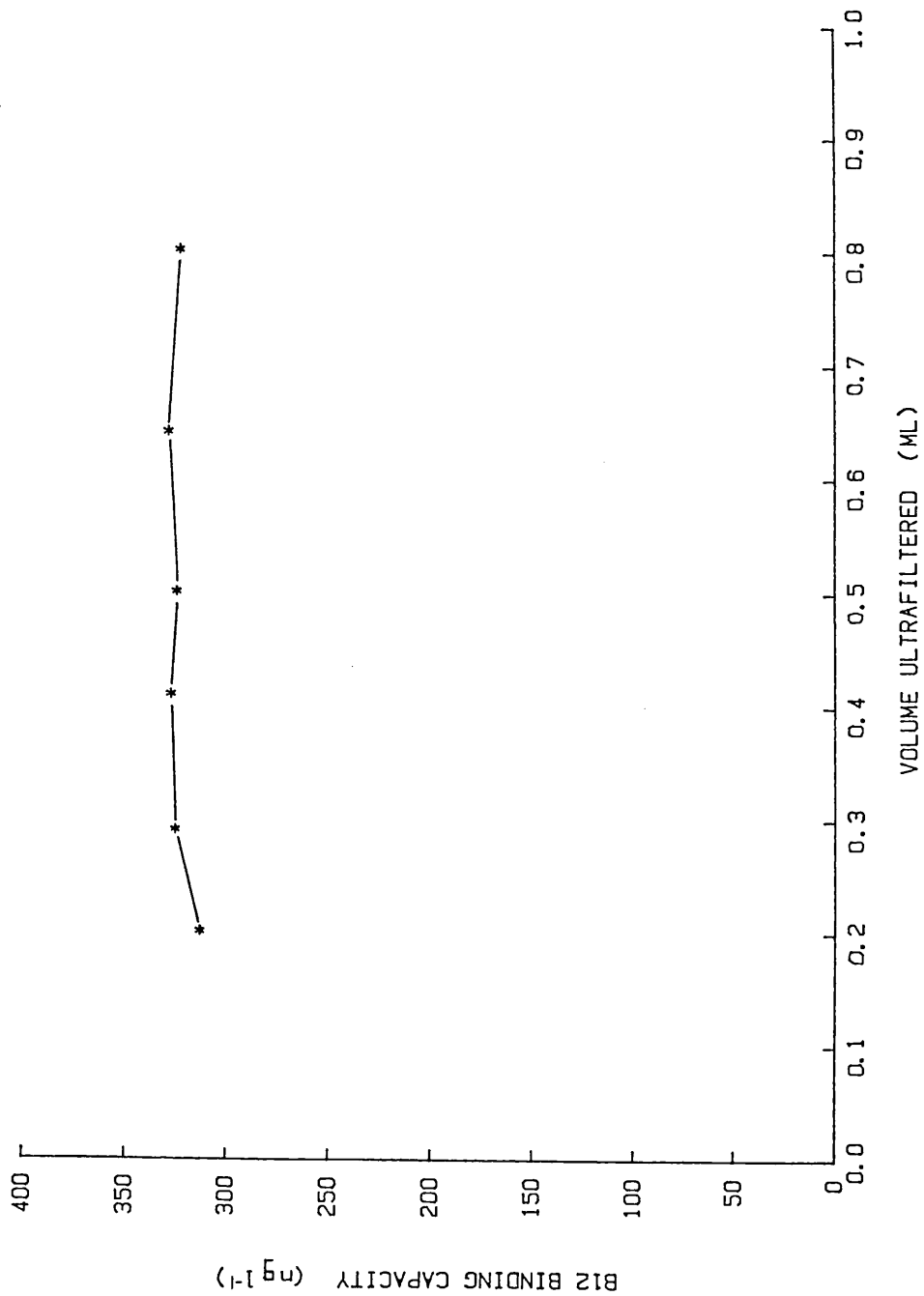

Figure 2.4 The effect of different volumes of ultrafiltrate collected on the B12 binding capacity of filtered D.primolecta medium estimated by ultrafiltration assay.

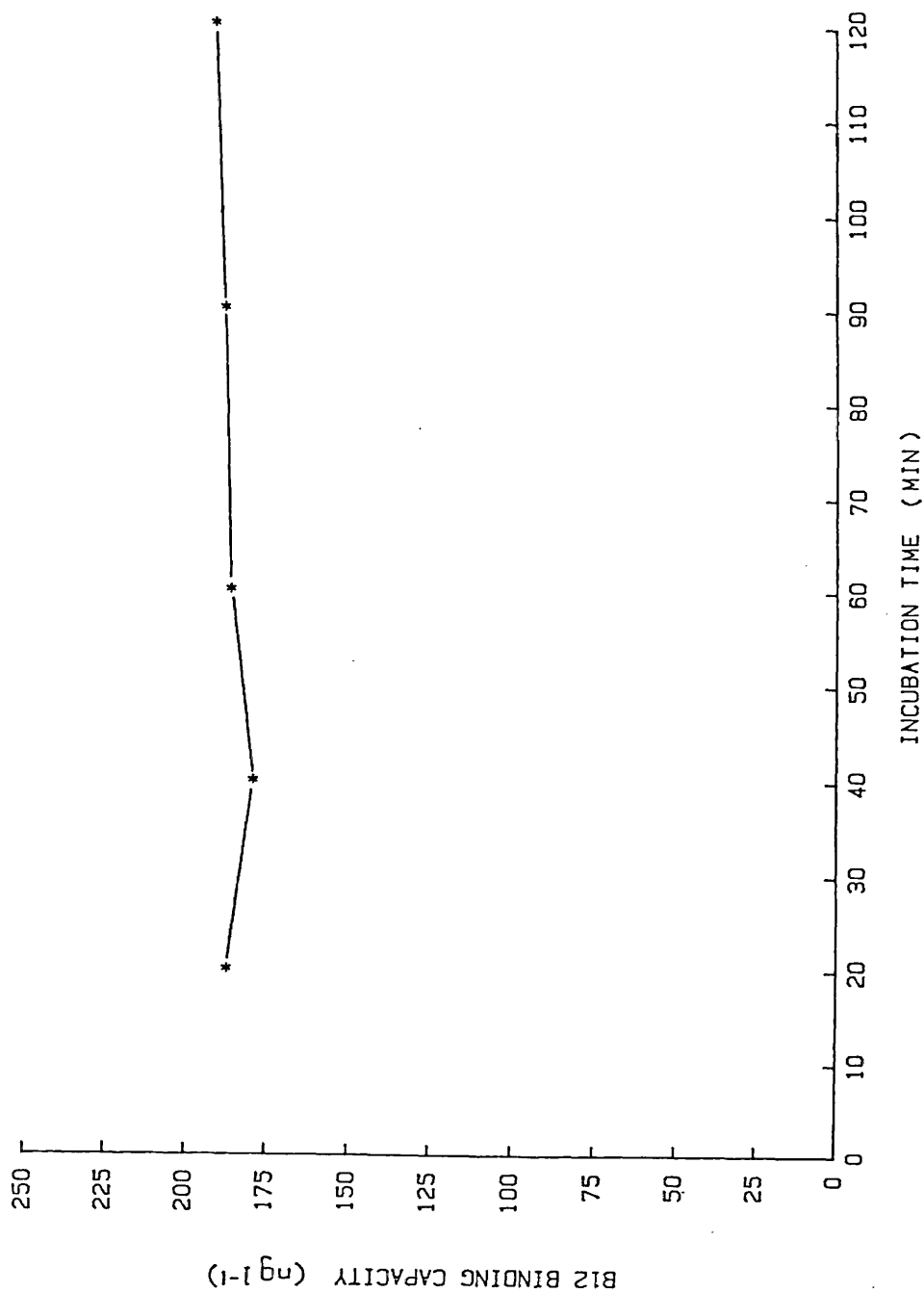

Figure 2.5 The effect of different incubation periods of <sup>57</sup>Co B12 with filtered D. primiolecta medium on the estimated binding capacity.

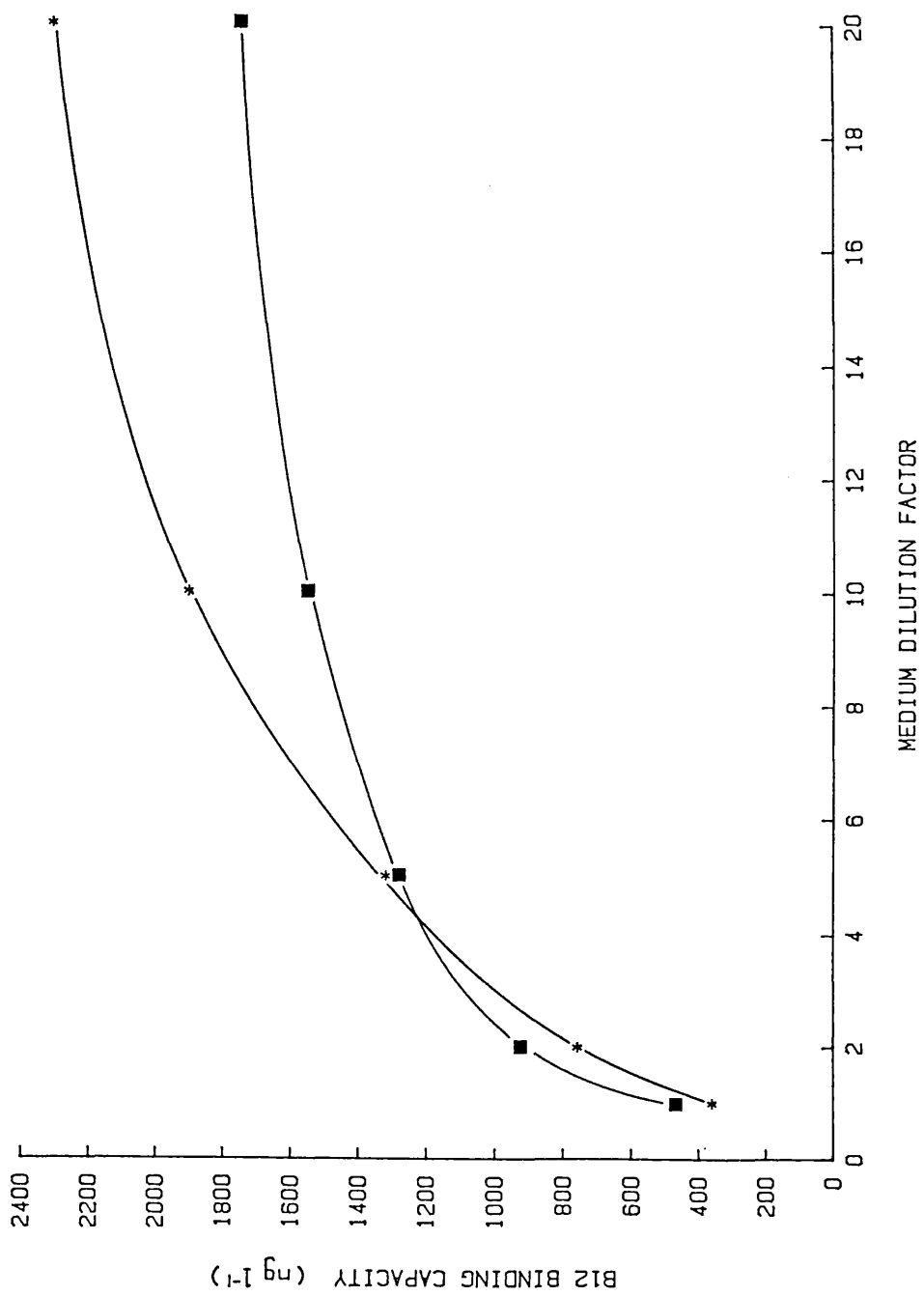

Figure 2.6 The estimated B12 binding capacity of filtered media of D. primolecta ( \* ) and P. lutheri ( ■ ) with different medium dilution factors used for assay.

DILUTION FACTOR (% ORIGINAL CONC.)	MEAN ESTIMATED B12 BINDING CAPACITY	MEAN STANDARD ERROR	% VARIATION
1 in 5 (20%)	1274 ng l <sup>-1</sup>	+/- 45 ng l <sup>-1</sup>	3.5
1 in 10 (10%)	1339 ng l <sup>-1</sup>	+/- 59 ng l <sup>-1</sup>	4.4
1 in 20 (5%)	1548 ng l <sup>-1</sup>	+/- 197 ng l <sup>-1</sup>	12.7

Table 2.5 Variation in the estimated B12 binding capacity of D.primolecta medium with different dilution factors used for assay.

## DISCUSSION

Although P.lutheri is commonly grown in alternative media such as S50 and S88 (Droop 1958, 1968), it was found to grow well in ASP2, enabling a common medium to be used for all studies.

From the simple trials conducted here, it appears that the nitrogen and phosphorus content of the medium was of prime importance in determining final yield. The necessity for the aeration of 5 litre cultures is thought to be mainly due to the inadequacy of simple diffusion for gaseous exchanges in the large volume of medium. Poor light penetration may also have been a factor. However, the culture conditions adopted enabled large quantities of the algae to be readily obtained.

After the comprehensive investigations described, it was clear that the B12 binding assay method was both rapid and reliable. This was in direct contrast to the inhibition neutralisation method of Pintner and Altmeyer (1979) which required culturing of the alga Thallassiosira pseudonana for 14 days for each assay. Additionally, the ultrafiltration technique provides a direct method for measuring B12 binders, and B12 binding capacities as low as 50 pg, equivalent to 35 fmole, were found to be detectable using the assay developed here.

Experiments into the parameters affecting the

assay resulted in the following standard procedures :  
0.454 ng of <sup>57</sup>Co B12 in 0.1 ml was added to 1 ml of 1  
in 10 diluted medium containing soluble binder. After  
incubation at room temperature for 1 hour, the free B12  
in 0.8 ml was separated by ultrafiltration, and the  
radioactivity in 0.1 ml of the free and total fractions  
counted. The B12 binding capacity of the sample can  
then be calculated as follows :

$$\frac{(\text{Total} - \text{Free}) \text{ cpm}}{\text{Total cpm}} \times \text{B12 concentration in incubation sample} \times \text{Dilution factor.}$$

It therefore provides a simple and accurate method  
for determining soluble B12 binding.

CHAPTER 3 - AN INVESTIGATION OF THE GENERAL  
CHARACTERISTICS OF ALGAL B12 BINDING PROTEINS.

INTRODUCTION

Comparatively little is known about algal B12 binders. Several studies have shown that a vitamin B12 binding factor is present in the medium of micro-algae (Ford, Gregory and Holdsworth 1955; Kristensen 1955; Droop 1968). Pintner and Altmeyer (1979) surveyed 21 species from 7 algal classes, and it is clear that extracellular binders are produced by a whole range of autotrophic and auxotrophic algae from both marine and freshwater environments.

These binders are proteinaceous in nature (Daisley 1970; Pintner and Altmeyer 1979) and have been shown to inhibit cell uptake, which operates on native B12, by competitively binding available vitamin (Droop 1962, 1968). Such inhibition is not species specific. The greatest quantities of these binders are found in the media of old cultures, but it is not clear whether they are released from cells at a constant relative rate, as suggested by Droop (1968) with the amount present depending on time and cell density, or whether extracellular binding is directly proportional to cell density alone (Ford 1958).

A series of experiments were therefore conducted to determine the pattern of extracellular B12 binder release, and other characteristics of these proteins. An investigation was also made into cellular B12 binding proteins, and a procedure developed for the isolation of extracellular, soluble intracellular and membrane-bound micro-algal binders to facilitate further study.

#### MATERIALS AND METHODS

##### Extracellular production.

For the investigation of extracellular production, 2 x 250 ml cultures in 500 ml conical flasks of both D.primolecta and P.lutheri were inoculated from logarithmic phase cultures to give  $1.0 \times 10^4$  and  $1.1 \times 10^4$  cells ml<sup>-1</sup> respectively, and grown axenically under the conditions detailed in Chapter 2.

Samples were taken aseptically at regular intervals for 55 days, and filtered through Whatman GF/A glass micro-fibre and 0.2  $\mu$ m cellulose nitrate membrane filters prior to protein determinations. Cell density was determined during the first few days of growth by Sedgewick rafter counts, and later by haemocytometric counting.



Extracellular B12 binder production was followed using a 1 in 10 dilution of the filtered medium, and the ultra-filtration assay described in Chapter 2. Additionally, total extracellular protein production was monitored using a variation of the coomassie brilliant blue (CBB) dye binding method of Bradford (1976). Modifications were as follows : The CBB G-250 reagent was filtered through a Whatman No.1 filter prior to use ; 0.2 ml of medium was added to 1 ml reagent to increase sensitivity.

Stability of extracellular binders.

The stability of the extracellular binders, in terms of their ability to bind B12, was investigated under a variety of conditions. Medium from cultures entering stationary phase was filtered as previously described, but aseptically and at 4°C to avoid contamination, then stored in sterile glass 10 ml containers. Binding capacity ultrafiltration assays were performed immediately, and subsequently at periods ranging from 2.5 hours to 1 month afterwards.

Relative cell and extracellular binding of B12 in the medium.

Using an aerated 5 litre batch culture of

P.lutheri in S88 medium containing  $100 \text{ ng l}^{-1}$  B12, the relative B12 binding affinities of cells and extracellular binder were investigated at 3 stages in the growth curve. A range of  $^{57}\text{Co}$  B12 concentrations between 24 and  $546 \text{ ng l}^{-1}$  were incubated with 10 ml of undiluted medium containing cells and binder. Aliquots were withdrawn at 1 and 3 hours. Cell binding was determined by collecting the cells by filtration onto a GF/F filter, and washing twice with fresh medium before counting in a sodium iodide well, crystal photo-multiplier head, coupled to a Panax Reigate Series RAD 54 scaler. The medium was then further filtered through a  $0.2 \mu\text{m}$  cellulose nitrate filter, before determining extracellular binding by ultrafiltration assay, using positive pressure from a syringe to achieve separation. Cell counts were performed using a Coulter Counter model B.

Relative B12 binding capacities of cellular and extracellular fractions.

The separative procedure developed to isolate extracellular, intracellular soluble and membrane-bound product fractions from unicellular algal cultures is shown in schematic form in Figure 3.1. Cells were harvested by centrifugation at  $5000g$  and  $10^\circ\text{C}$ . A continuous flow rotor system was used for culture

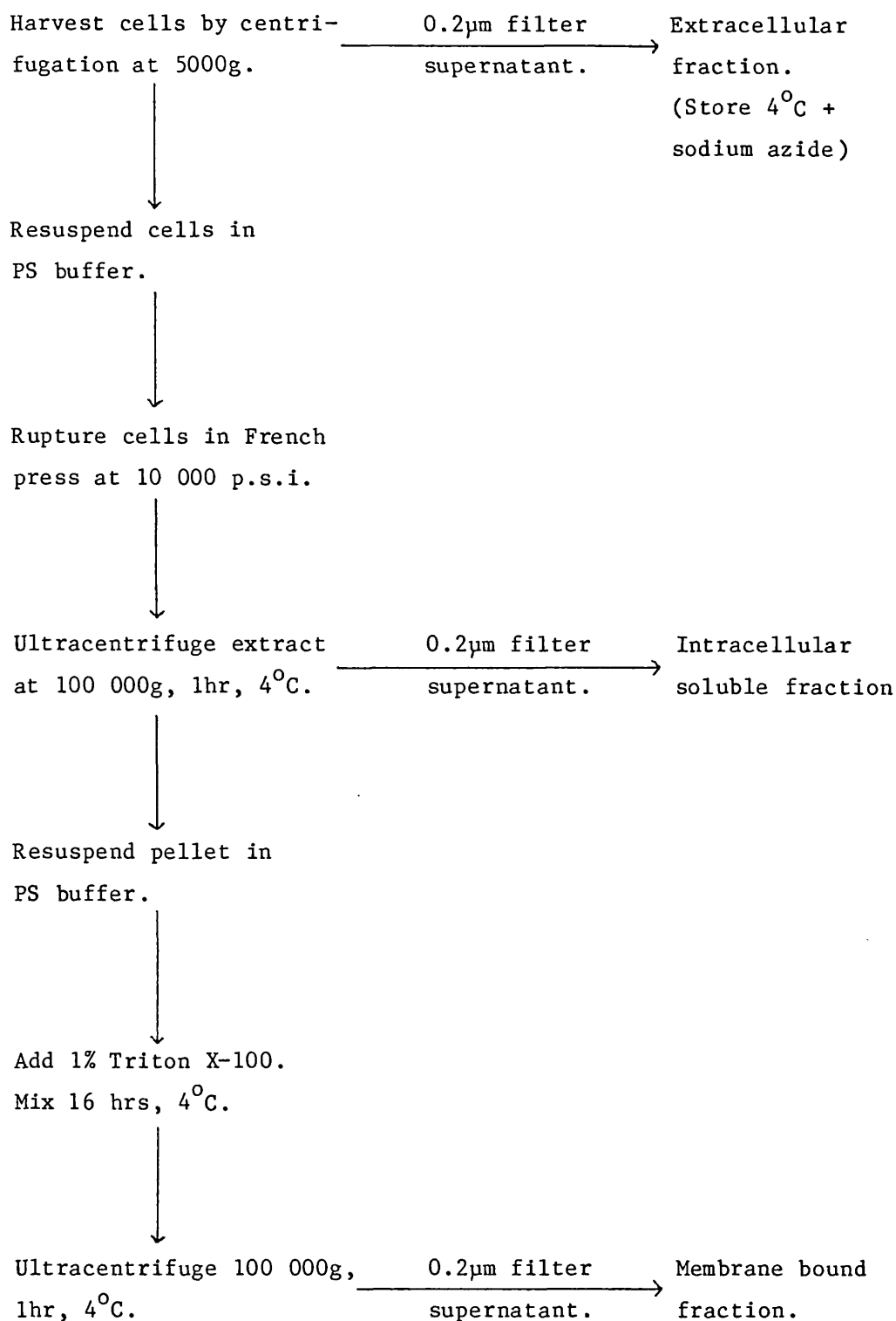

FIGURE 3.1 Outline of the procedure used to isolate extracellular, intracellular cytosolic and membrane bound product fractions from unicellular algal cultures.

volumes in excess of 1 litre. The supernatant medium, containing the extracellular products, was collected in a sterile container on ice, and filtered through a high loading capacity GF/B glass micro-fibre filter, then a 0.2  $\mu\text{m}$  cellulose nitrate filter to remove any remaining cells and debris. 0.01% sodium azide was added to inhibit any microbial growth, and the medium kept at 4°C prior to use. Ultrafiltration assay tests showed that B12 binding was completely unaffected by the presence of 0.02% sodium azide.

Cells were resuspended in 80 ml 0.5 M NaCl / 0.05 M potassium phosphate buffer, pH 7.2 (PS buffer) at 4°C. This was followed by rupture in a French pressure cell at 9000 to 10 000 p.s.i, pre-cooled to 4°C. The resultant slurry was ultracentrifuged at 100 000g and 4°C for 1 hour. The supernatant, containing intracellular soluble products, was GF/A and 0.2  $\mu\text{m}$  filtered, and 0.02% sodium azide added. This was then stored at 4°C before use.

The pellet containing membrane fragments and organelles was resuspended in 80 ml PS buffer, and mixed with 1% Triton X-100 at 4°C for 16 hours. This treatment has been shown to solubilise membrane proteins (Seligman and Allen 1978). A final ultracentrifugation at 100 000g and 4°C for 1 hour gave a supernatant containing membrane-bound cell products. This was also GF/A and 0.2  $\mu\text{m}$  filtered, and 0.02%

sodium azide added as above, prior to storage at 4°C.

Using extracts prepared by this procedure, and diluted to 10% of their original concentration, the soluble B12 binding capacity of all three fractions was determined by ultrafiltration assay.

## RESULTS

### Extracellular production.

The extracellular production of total and B12 binding proteins by cultures of D.primolecta and P.lutheri is shown in Figures 3.2 and 3.3 respectively. It is clear that the amount of binder and total protein present in the medium of both species is primarily a direct function of the cell density. Release does not, therefore, depend on the age or growth phase of the culture. There is, however, a small rise in protein concentrations 30 to 35 days after inoculation, approximately 10 days into stationary phase. This could be due to the release of intracellular material resulting from cell lysis and / or the small amount of binder released by those new cells which are produced.

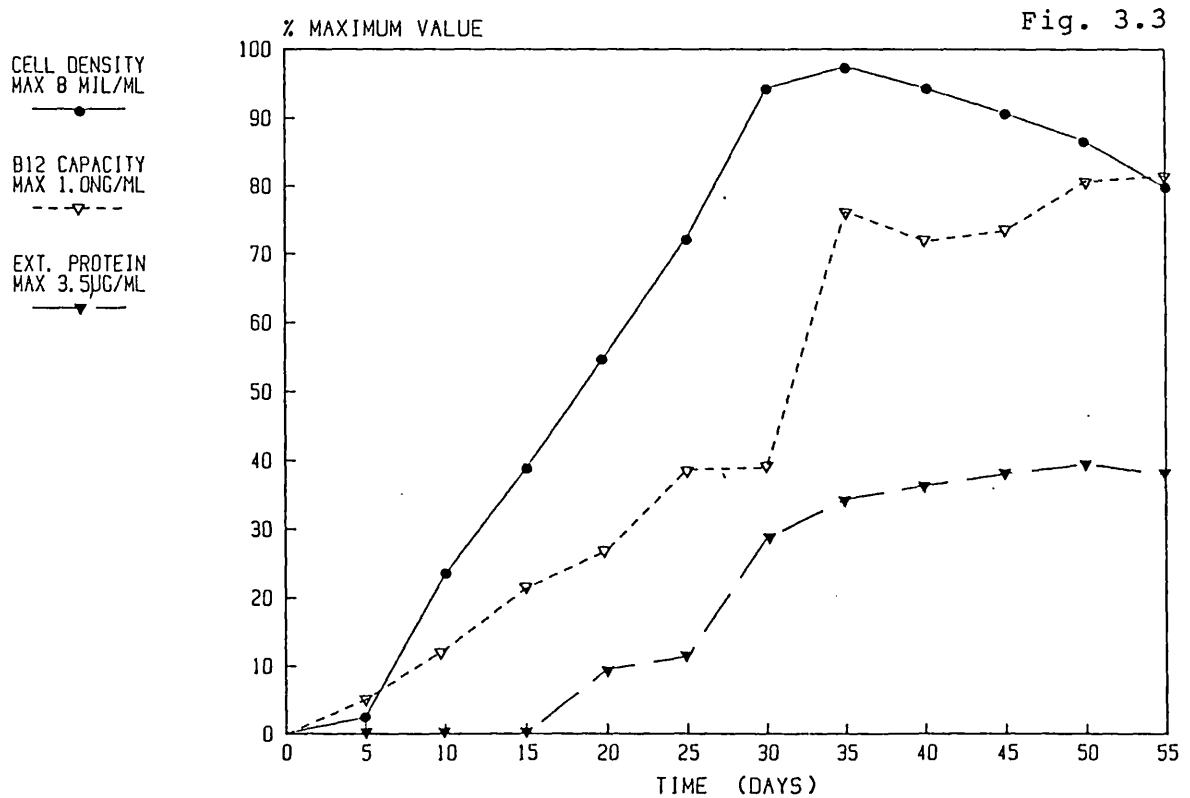
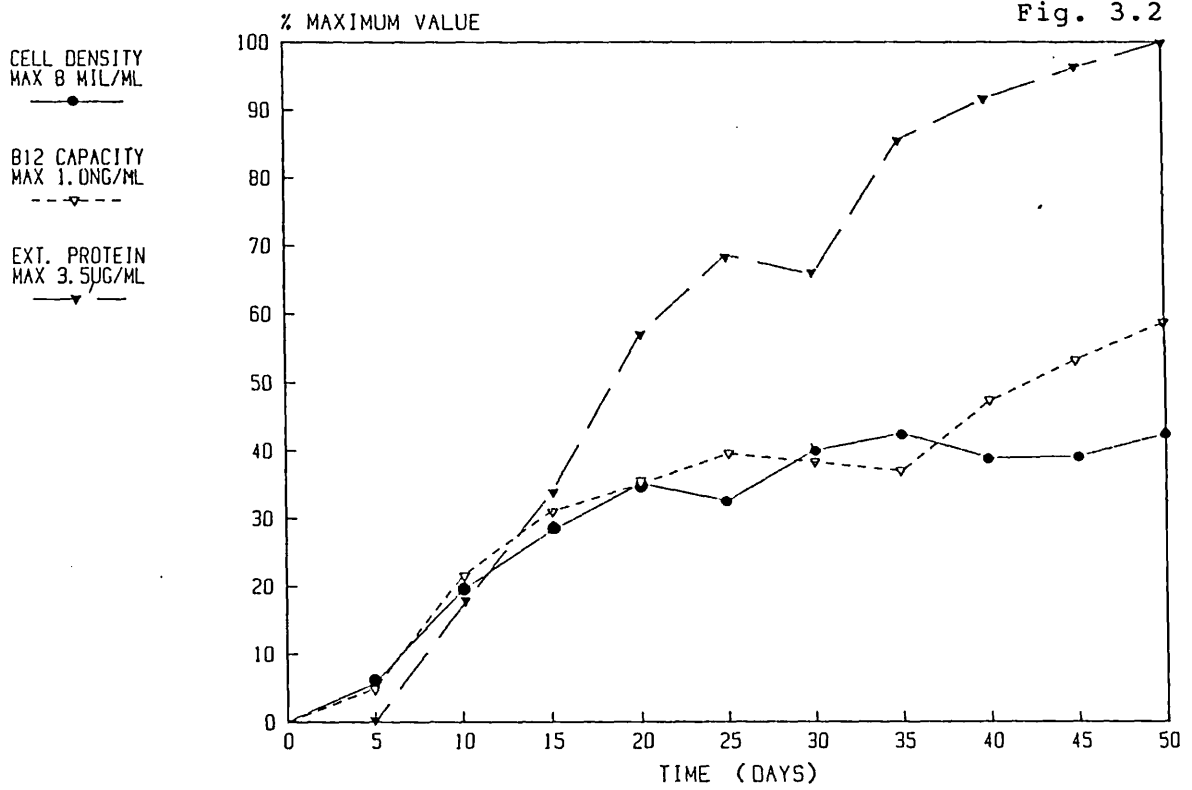

Figures 3.2 and 3.3 The cell density, extracellular B12 binding and total extracellular protein production of *D. primolecta* (3.2) and *P. lutheri* (3.3) monitored throughout the growth curve.

Stability of extracellular binders.

Table 3.1 shows the B12 binding capacity of extracellular binders of D.primolecta and P.lutheri, stored under various conditions for up to 1 month, relative to their original binding activity. In most cases, over 90% of B12 binding capacity is retained. However, storage in the presence of cells, or at room temperature in the light for 28 days, results in a significant loss of binding activity. Binders from the two species behave slightly differently under these conditions, although this is not particularly significant.

It is, of course, possible that some or all of the observed loss of B12 binding capacity is due to breakdown resulting from microbial contamination. This is not thought particularly likely though, due to the use of aseptic techniques. The slight increases in binding activity reported are considered to be due to experimental error. As might be expected, both show a small decrease in binding after storage at  $-20^{\circ}\text{C}$ . This is thought to be due to deformation of the tertiary protein structure upon freezing.

It would appear therefore that under natural conditions, extracellular B12 binders should be relatively stable, but would be gradually degraded and inactivated.

STORAGE CONDITIONS	STORAGE PERIOD	% ORIGINAL B12 BINDING CAPACITY D.primolecta medium      P.lutheri medium	
Room temperature in light	2.5 Hours	98.9	98.6
	24 Hours	98.4	101.7
R.T in dark	7 Days	96.9	-
	28 Days	88.8	65.3
4°C in dark	28 Days	101.9	80.6
	28 Days	103.2	105.4
4°C in dark + cells	28 Days	81.9	90.8
	28 Days	90.7	92.4
Frozen	28 Days		

Table 3.1 The B12 binding capacity of extracellular proteins of D.primolecta and P.lutheri stored under various conditions relative to their original binding activity.



Relative cell and extracellular binding of B12 in the medium.

The concentration dependence of B12 binding by cells and extracellular binding protein, incubated together with the vitamin, was examined at three phases in the growth curve of P.lutheri as follows :

Figure 3.4 shows the results obtained when the culture was entering log. phase with a cell density of  $0.106 \times 10^6 \text{ ml}^{-1}$ , 3 days after inoculation and a subsequent short lag phase. The sampling in mid-logarithmic phase with a cell density of  $1.09 \times 10^6 \text{ ml}^{-1}$  is shown in Figure 3.5, and Figure 3.6 shows results with the culture at the end of its logarithmic phase and  $2.03 \times 10^6 \text{ cells ml}^{-1}$ .

At low cell densities, before the exponential phase has got underway, the cells are saturated above  $125 \text{ ng l}^{-1}$  of B12. Extracellular binding, while negligible at low B12 concentrations, increases with incubation concentration up to the maximum of  $537 \text{ ng l}^{-1}$ . In mid-logarithmic phase, cell binding does not approach saturation, even at  $546 \text{ ng l}^{-1}$  B12. Although somewhat higher at incubation concentrations below  $150 \text{ ng l}^{-1}$  than in the earlier sampling, extracellular B12 binding increases relatively little at higher concentrations, representing only 5.4% of cell binding. However, as the culture approaches

Figures 3.4, 3.5 and 3.6 The concentration dependence and partition of B12 binding by cells ( \* ) and extracellular binder ( ■ ) of P.lutheri at three stages in the growth curve: at the start of the logarithmic phase (Fig. 3.4), during exponential growth (Fig. 3.5) and entering stationary phase (Fig. 3.6).

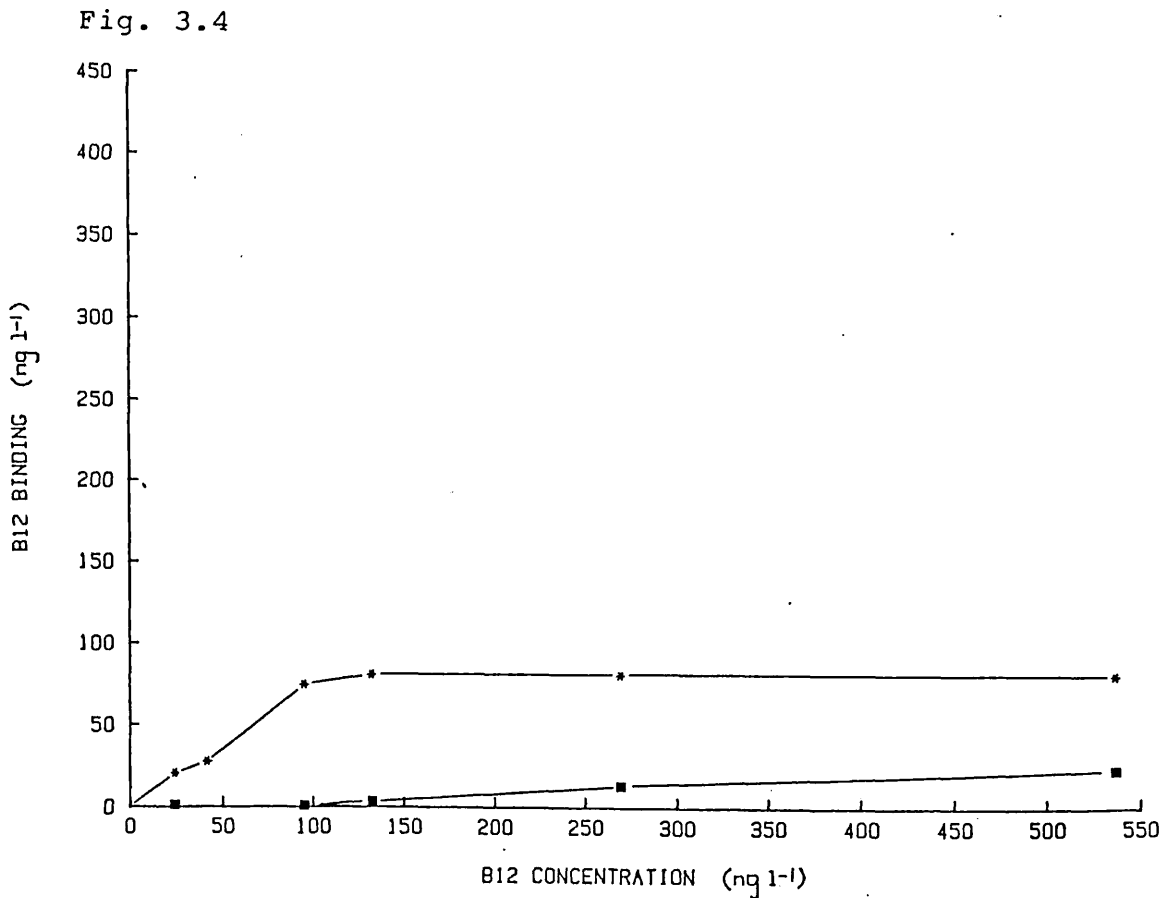

Fig. 3.5

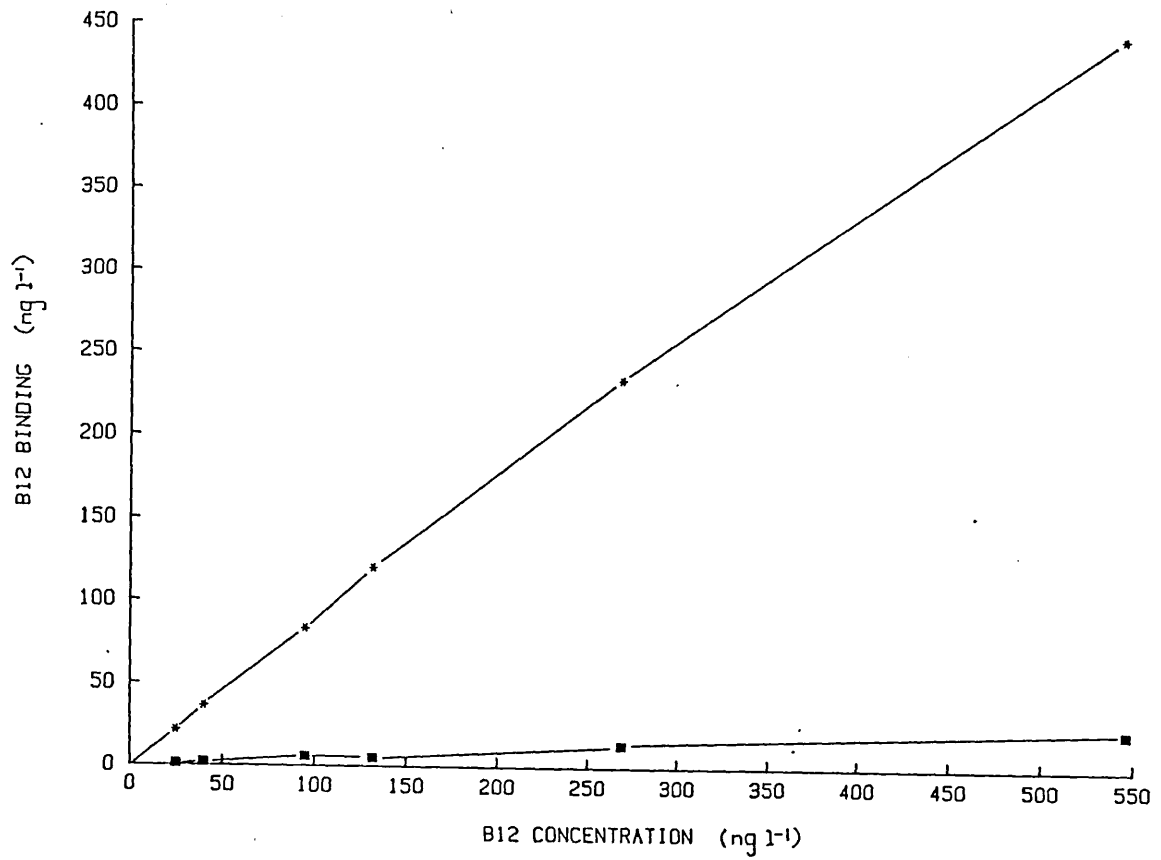
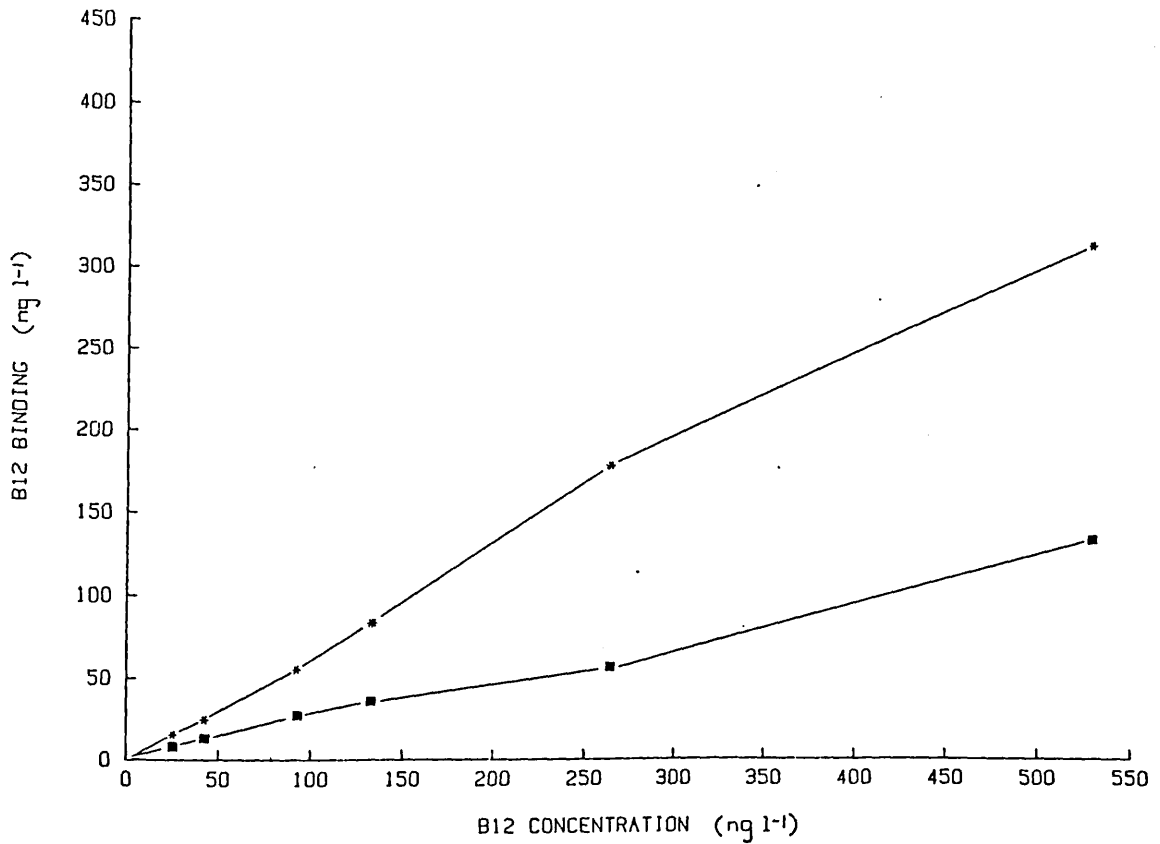

Fig. 3.6



stationary phase, extracellular binding increases dramatically and represents 42.2% of cell-bound B12.

It therefore seems that at early stages of growth, cells have a high affinity for B12 and bind a higher proportion of available vitamin. As the culture ages, cell binding affinity decreases while extracellular binding increases markedly.

Relative B12 binding capacities of cellular and extracellular fractions.

Using the separative procedure previously described, it was found possible to identify B12 binding proteins associated with the intracellular cytosolic and membrane-bound fractions, as well as in the extracellular medium of both D.primolecta and P.lutheri. The average total B12 binding capacity of each fraction is given in Table 3.2.

The relative proportions are shown in Figure 3.7. However, samples taken from different D.primolecta cultures showed variation in the relative binding capacities of the three fractions, particularly in the proportion of intracellular binder. This is shown in Table 3.3.

PRODUCT PHASE	D.PRIMOLECTA	P.LUTHERI
Membrane-bound	809 ng l <sup>-1</sup>	568 ng l <sup>-1</sup>
Intracellular	264 ng l <sup>-1</sup>	161 ng l <sup>-1</sup>
Extracellular	434 ng l <sup>-1</sup>	556 ng l <sup>-1</sup>

Table 3.2 The average total B12 binding capacity associated with the three product fractions isolated from D.primolecta and P.lutheri.

PRODUCT PHASE	MINIMUM BINDING	MAXIMUM BINDING
Membrane-bound	42.8 %	57.5 %
Intracellular	11.4 %	31.0 %
Extracellular	26.2 %	31.1 %

Table 3.3 Variation in the % of total B12 binding capacity of the three product phases isolated from D.primolecta.

DUNALIELLA PRIMOLECTA PROTEINS

PAVLOVA LUTHERI PROTEINS

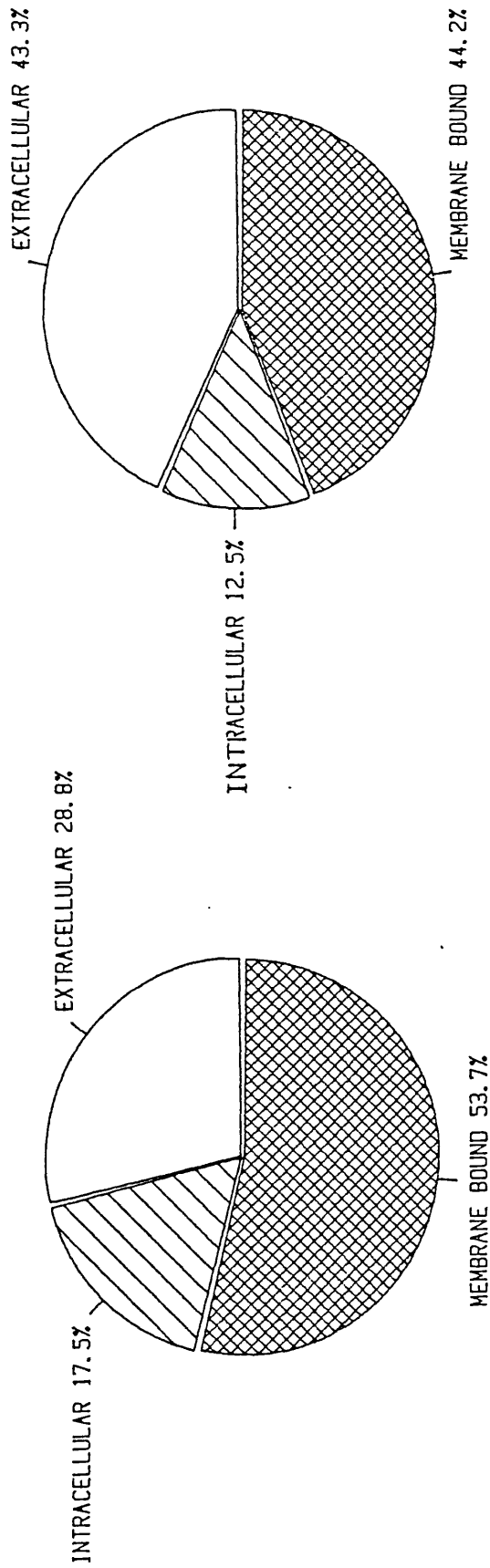

Figure 3.7 The relative total B12 binding capacities of proteins isolated from the extracellular, intracellular and membrane-bound fractions of D.primolecta and P.lutheri.

DISCUSSION

The pattern of extracellular B12 binding protein release shown for D.primolecta and P.lutheri supports the suggestion of Ford (1958) working on Ochromonas malhamensis, and the findings of Pintner and Altmeyer (1979) for P.lutheri, that the amount of binder present in the medium is primarily proportional to the cell density alone. However, in the same paper Pintner and Altmeyer reported that binder was released at a constant rate by D.primolecta cultures, and that the amount of extracellular binding depended on the age of the culture. This conclusion was almost certainly due to only four sampling points, resulting in a highly unreliable data fit. The indirect method of assay, namely inhibition neutralisation, may also have led to inaccuracies.

The studies on cell and extracellular B12 binding at various stages in the growth curve reported here reveal interesting changes in the amounts bound by the two phases. While in the middle of exponential growth, cells bind over 90% of available B12, and extracellular binding is negligible. As stationary phase approaches in batch culture, cell and extracellular binding of B12 represents 59% and 25% of the available vitamin respectively.

However, it has already been demonstrated that the

amount of extracellular binder is directly proportional to cell density. Thus greater EBP release does not account for the observed changes in cell and extracellular binding.

What has been shown is that total B12 binding by cells decreases after mid-logarithmic phase. A similar observation was made by Droop (1968) who reported a ten-fold decrease in cell surface B12 binding between cells in exponential and stationary phases. This was concomitant with an increase in the half saturation constant for cell surface B12 adsorption.

It may therefore be argued that the high cell binding affinity in exponential phase precludes a large amount of extracellular binding. Hence the observed fall in cell bound B12, and the higher proportion of extracellular binding shown as the culture approaches stationary phase, is due primarily to a lower cell binding affinity, rather than increased extracellular binder.

This change in affinity and relative cell and extracellular binding may suggest two different mechanisms, and is considered to be of interest to the general situation regarding algal B12 binding.

As the proportion of B12 bound by extracellular proteins remains small until the end of the log. phase, it will not therefore significantly affect vitamin uptake and hence growth rate at earlier stages. Thus



the development of an initial bloom of either an autotroph or auxotroph would be unaffected by their extracellular production. However, if it remains in the environment it will clearly sequester some of the available B12, which is likely to be in limited supply, and thus retard the growth of subsequent species.

As what might be regarded as "medium-term" stability of the extracellular binder under natural conditions, feasibly retaining around 50% of its activity during a single growth season, has now been demonstrated, this is a distinct ecological possibility.

If binder released into the medium does indeed have an inhibitory effect on later-developing competitive species, this would provide an explanation for the initially apparently deleterious production of the extracellular binders. Additional support for this idea comes from the work of Messina and Baker (1982) and Davies and Leftley (1985). The former showed that, in laboratory culture, the aseptically filtered medium of Gonyaulax tamarensis and Cyclotella cryptica competitively inhibited the growth of B12 limited cultures of the auxotroph Skeletonema costatum. This was due to the presence of extracellular B12 binder.

Davies and Leftley (1985) found that extracellular algal B12 binders from a range of species had a high affinity for the vitamin, with values for the

association constant,  $K_a$  , around  $2.9 \times 10^{11}$  to  $10^{12}$   $M^{-1}$ . This perhaps suggests that these are not merely randomly released by-products, but may have some functional significance.

Furthermore, the current investigation of cellular B12 binders reveals the large proportion of extracellular binding, around 30-40% of the total bound B12. This was somewhat unexpected, and is not readily explained unless extracellular binders perform some role, as the excretion of high molecular weight compounds from the cell is considered to be an energy requiring process.

However, these theories attributing a role as an ectocrine, i.e. a substance with growth inhibiting properties influencing other species, to extracellular binders are somewhat hypothetical. Clearly, information on the origin of these proteins and their relationship to the cellular B12 binders is therefore required to further elucidate their significance in algal B12 binding.

CHAPTER 4 - THE DEVELOPMENT OF A PURIFICATION  
SYSTEM FOR ALGAL VITAMIN B12 BINDING PROTEINS.

INTRODUCTION

To determine the origin of algal vitamin B12 binding proteins, their functions in uptake of the vitamin and the mechanism of the actual uptake process, more information was required regarding the nature of the proteins themselves.

As mentioned in Chapter 1.4, much information about the mammalian B12 uptake system has been obtained by the isolation and characterisation of the proteins involved. Consequently, it was decided to attempt purification of algal B12 binders from all three fractions in which they had been identified.

Daisley (1970) tried to purify extracellular and intracellular binders from Euglena gracilis. However, final yields and homogeneity were poor. Similar difficulties had beset mammalian studies until the development of affinity chromatography purification systems, utilizing vitamin B12 derivatives. Early methods necessitated two-stage procedures or harsh recovery conditions (Allen and Mehlman 1973; Francis, Smith, Toskes and Sanders 1977). In contrast, a method reported by Jacobsen, Montejano and Huennekens (1981)

is a rapid, essentially single-step process based on a photo-sensitive B12 derivative, aminopropylcobalamin.

It was therefore decided to develop a purification scheme based on this procedure.

#### MATERIALS AND METHODS

Concentration of B12 binding proteins.

To reduce the large volume of the extracellular media containing binding proteins, and to facilitate handling of the binder preparations, it was desirable to have a way of concentrating binding proteins in solution. Several methods were investigated for their efficiency using filtered D.primolecta medium containing binder.

Firstly, an attempt was made to adsorb the binding protein onto calcium phosphate gel, enabling it to be subsequently liberated into a smaller volume of buffer of suitable ionic strength. Initially, gel was added to the medium in the ratio 3mg dry weight gel per mg total protein, as estimated by the coomassie blue technique described in Chapter 3. This was thoroughly mixed for 30 mins at room temperature, and the gel collected by centrifugation at 700g for 10 mins. The gel was then sequentially washed in 0.02 M and 0.1 M phosphate

buffer pH 7.4 by resuspension and mixing in the buffer for 20 min, followed by centrifugation. The B12 binding capacity of the original medium, the treated medium and the phosphate buffer washes was determined by ultrafiltration assay using undiluted samples. Subsequently, a similar experiment using 100 mg gel per mg total protein was tried.

Secondly, concentration was attempted by ultrafiltration using an Amicon YM10 membrane and stirred ultrafiltration cell model 12. 20 ml medium was reduced to 2.09 ml by ultrafiltration under 15 p.s.i, and then diluted back to 20 ml with fresh ASP2 medium. Ultrafiltration assays were performed on this and the original medium.

Aquacide IV (Calbiochem) is a polyacrylamide granular crystalline solid which absorbs water and other small compounds with molecular weights below approximately 20 000. 11 ml of medium was added to 2 g aquacide IV for 5 hours at room temperature, which reduced the volume to 1.01 ml. This was diluted back to 11 ml with fresh, sterile ASP2 and assayed for B12 binding capacity, along with a sample of the original medium. This procedure was also followed using filtered P.lutheri medium.

Finally, 5 ml of D.primolecta medium contained in Visking cellulose tubing was dialysed against granular sucrose until the volume had been reduced to

approximately 1 ml, and then exhaustively against PS buffer. This was performed at 4°C with changes of dialysates as necessary. The contents of the dialysis tubing were diluted to 5 ml, and the B12 binding capacity compared with a sample of original medium.

Development of an affinity chromatography procedure.

Preparation of the affinity adsorbent on which the purification scheme was based required a suitable support matrix and the synthesis of the affinity ligand, aminopropylcobalamin (APC). The latter was achieved by the conversion of commercially available hydroxocobalamin (Sigma) by the method detailed in Table 4.1. This was produced by Prof. Golding and Ruth Dixon of Newcastle University, and resulted in a homogeneous product.

The original method of Jacobsen et al. (1981) utilized sephacryl S-200 as the support matrix. However, this has a nominal exclusion limit of 250 000. Since the work of Daisley (1970) suggested a molecular weight in excess of 200 000 for algal B12 binders, S-200 would represent a highly inefficient matrix as the binding proteins would be unable to occupy affinity sites within the beads. This was therefore considered unsuitable, and CN-Br activated sepharose 4B, with an exclusion limit of around 20 million, was chosen for

Dissolve 1.5 g hydroxocobalamin in 100 ml H<sub>2</sub>O along with 50 mg Co(NO<sub>3</sub>)<sub>2</sub>, and degas by N<sub>2</sub> bubbling for 30 min.

Add 0.3 g sodium borohydride in 5 ml H<sub>2</sub>O.

Add 1.3 g 3'-chloropropylamine hydrochloride dissolved in 5 ml H<sub>2</sub>O, and continue N<sub>2</sub> flushing. (At this stage a complete conversion to 3'-aminopropylcobalamin is shown by TLC).

Add 1 ml acetone to decompose excess borohydride, then extract by the addition of phenol : CH<sub>2</sub>Cl<sub>2</sub> (100 gm in 100 ml).

Wash the organic extracts once with H<sub>2</sub>O and remove CH<sub>2</sub>Cl<sub>2</sub> by the passage of N<sub>2</sub>.

Pour the residual phenolic solution into 200 ml acetone : ether (1:9) to precipitate the cobalamin, which can then be collected by centrifugation.

Wash several times with dry ether to remove traces of phenol.

Store at -20°C in an air-tight, foil wrapped vial in the dark.

Table 4.1 The method for preparation of 3'-aminopropylcobalamin from hydroxocobalamin.

initial development.

APC was coupled to this matrix as follows :  
APC was dissolved in 0.2 M NaHCO<sub>3</sub> to produce a 2.5 mM solution. CN-Br activated sepharose 4B was pre-swollen in 1 mM HCl (200 ml gm<sup>-1</sup>) for 15 mins at room temperature in a ratio of 1 gm : 2 ml, before washing with the bicarbonate buffer. The swollen beads were then immediately added to the APC solution, and mixed for 16 hrs at 4°C. These conditions minimised non-specific coupling and hydrolysis of the active ester groups in the matrix. This and all subsequent stages involving APC were carried out under dim red safe light illumination to avoid photolytic conversion to aquacobalamin, which occurs below approximately 600 nm.

The beads were collected by gentle suction filtration onto a Sinta-glass filter porosity 3, and mixed with 1 M sodium glycinate for 2 hrs at room temperature to block any remaining unoccupied coupling sites. They were then washed three times with PS buffer, and stored prior to use in 5 mM EDTA/PS buffer at 4°C in the dark. The NaHCO<sub>3</sub> solution containing unbound APC, sodium glycinate solution and PS buffer used to wash the beads were collected and their absorption determined at 538 nm, the principal APC absorption band. This allowed the efficiency of coupling of APC to the gel support to be calculated by comparison with the absorption of the 2.5 mM APC



solution, and hence the total affinity ligand bound to matrix determined.

In order to assess whether this affinity purification matrix was an effective method for recovering algal B12 binding proteins, an initial trial was conducted to determine the percentage of binding activity adsorbed onto the APC-sepharose 4B with varying contact times. A volume of the affinity matrix, with an APC concentration equivalent to 100 times the estimated B12 binding capacity of the sample of filtered D.primolecta medium to be used, was packed under gravity into a 1.6 cm diameter LKB chromatography column fitted with flow adaptors. This was equilibrated with PS buffer at 50 ml hr<sup>-1</sup> for 1 hr. Filtered culture medium was then passed through the column at room temperature, using a peristaltic pump at the three different rates, and the eluates collected. These were assayed for B12 binding capacity, along with a sample of the original medium.

Since APC is a relatively small molecule (MW=1387), it was thought possible that steric hindrance effects could reduce the binding efficiency of the proteins. Therefore, a supporting matrix incorporating an integral 10 atom spacer arm to which APC would couple, namely affi gel 10 (Bio-Rad), was investigated for possible use. Coupling procedure was identical to that used for sepharose 4B, except that

affi gel 10 is supplied pre-swollen and was merely washed prior to use, and the recommended mixing period of 4 hrs was used. This chemical coupling of APC to affi gel 10 and sepharose 4B is shown diagrammatically in Figure 4.1.

Experiments were conducted to compare the efficiency of the two matrices and the effect of medium flow rates through the affinity columns on binding protein recovery. The method used was similar to that in the initial trial of APC-sepharose 4B, and medium was pumped through columns of equal volumes of the two matrices, at flow rates of 50, 100, 200 and lastly 25 ml hr<sup>-1</sup> for 2 hrs, 1 hr, 0.5 hr and 2hrs respectively. Eluates were collected at each flow rate after allowing 25 ml to pass through the column, and assayed for B12 binding capacity. Following pumping of the medium, the columns were washed with PS buffer at 100 ml hr<sup>-1</sup> for 2 hrs to remove all extraneous materials, which was confirmed by undetectable absorbance at 280 nm in the eluate. This was followed by photolysis for 30 mins using 3 x 100 W tungsten bulbs at 30 cm and 2 fluorescent room lights, with cooling from an electric fan to prevent any significant temperature increase. The column volume was pumped out and collected, and this photolysis procedure repeated twice more. Thus all APC, and any material bound to it, was liberated from the support matrix and collected.

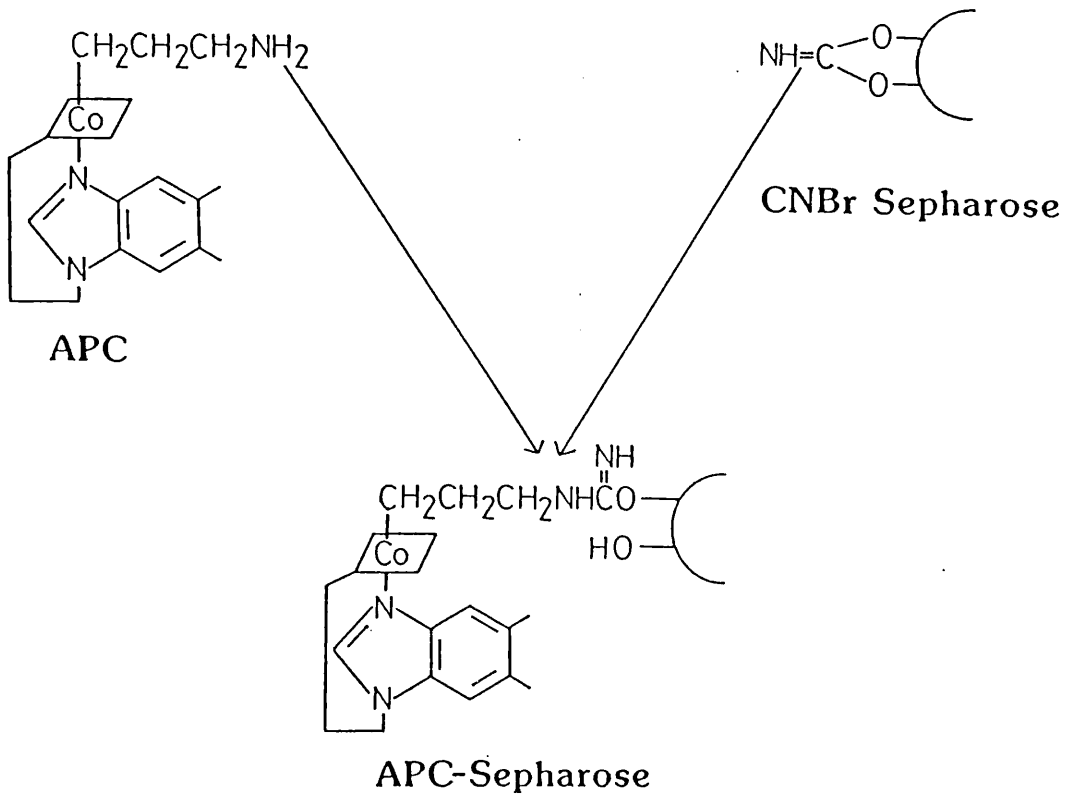
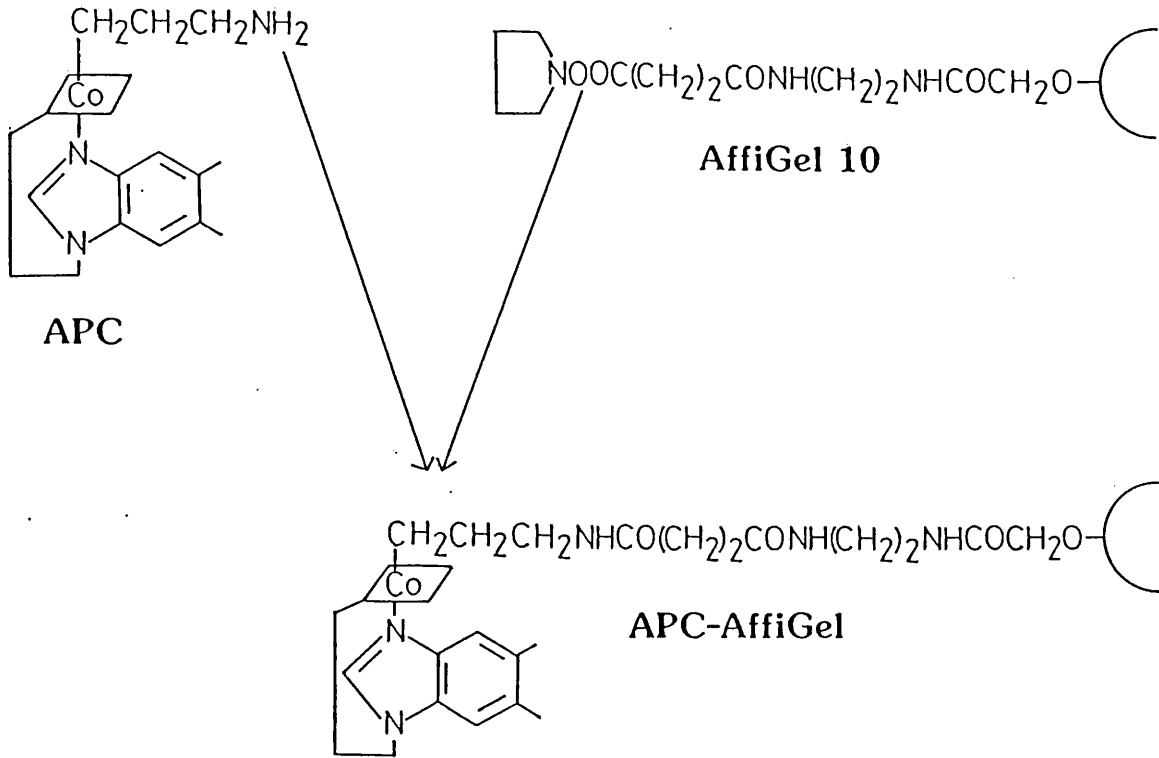

Figure 4.1 A diagrammatic representation of the coupling of APC to affi gel 10 and CN-Br activated sepharose 4B matrices.

As it was desired to carry out the purification procedure at 4°C to minimise contamination, the effect of temperature on the system was investigated. The efficiency of binding protein recovery was determined after pumping medium through an APC-affi gel 10 column at 4°C, and room temperature (23°C), using a flow rate of 200 ml hr<sup>-1</sup>. Also, a variation of the column method was investigated at these temperatures by batch mixing 100 ml of medium with the affinity matrix in a 250 ml stoppered dark reagent bottle. This allowed much longer contact times to be achieved. After mixing, the beads were collected by suction filtration onto a Sinta-glass filter porosity 3, then washed 6 times with PS buffer and photolysed in a procedure similar to that for the column. Centrifugation at 700g was also used to collect the beads after batch mixing.

Separation of free and protein bound cobalamin.

The medium collected after photolysis contained both B12 binding protein complexed to aquacobalamin and the free derivative. It was therefore necessary to achieve separation. The three photolysates were combined, and concentrated to approximately 1 ml by sucrose dialysis. Separation was performed at 4°C on a 13 x 2.6 cm column of Sephadex G-75 using a flow rate of 40 ml hr<sup>-1</sup>, and PS buffer as eluent. Outflow was

monitored at 277 nm using an absorbance range of 0.2 for the complexed protein and 1.0 for the free cobalamin. 50 drop fractions, equivalent to 2.45 ml, were collected.

Investigations were also carried out to determine whether the gel filtration matrices G-75, and G-200 (used subsequently for characterization) adsorbed the purified binding proteins. 1 ml of filtered P.lutheri medium containing binder was mixed with 0.5 ml swollen gel for 24 hrs at 4°C. The gel matrix was collected by centrifugation at 700g, and the binding activity of the supernatant compared with that of untreated medium by ultrafiltration assay. A correction factor due to dilution by the void volume was calculated and applied to the results.

Estimation of purified binding protein concentration.

It was clearly necessary to be able to estimate the quantities of purified binding protein recovered, preferably by a non-destructive procedure. Three methods were compared as follows :

The concentration of a protein solution can be estimated by its absorption characteristics at 260 and 280 nm. This non-destructive method as given in Dawson, Elliot, Elliot and Jones (1969) was used, but required an additional modification, due to the

presence of aquacobalamin bound to the protein. This has an absorption co-efficient at 282 nm of  $\epsilon_{mM}=19.2$ , as well as a principal absorbance band at 538 nm ( $\epsilon_{mM}=8.8$ ) when bound to protein (Jacobsen et al. 1981). Determination of the absorption spectrum of aquacobalamin revealed that absorbance at 260 nm and 280 nm was almost identical to that at 282 nm. Therefore measurement of the absorbance of the sucrose dialysis concentrated protein-complex solution at 538 nm allowed a value for absorption due to the cobalamin at 260 and 280 nm to be calculated. This was subtracted from the measured 260/280 values to give the absorption due to protein alone as follows :

Absorption wavelength	Absorption of protein-complex solution
260 nm	$X_1$
280 nm	$Y_1$
538 nm	$Z$

Absorption at 260 nm due to protein alone

$$X_2 = X_1 - Z \times 19.2 / 8.8$$

Absorption at 280 nm due to protein alone

$$Y_2 = Y_1 - Z \times 19.2 / 8.8$$

The coomassie blue dye binding technique (see Chapter 3) was also used to determine protein concentration; 0.2 ml of the pooled fractions eluted from the G-75 column containing the binding protein complex were added to 1 ml reagent. Although assaying the unconcentrated solution gave a low absorbance reading at 595 nm, and therefore probably resulted in a reduction in accuracy, it minimised the loss of purified protein by this destructive method.

An additional method of calculating the concentration of the purified protein was used when it was subsequently analysed for amino acid composition (see Chapter 5). The area of each amino acid peak was determined from the trace obtained to give the amount present. These were then added together to give the total amount of proteinaceous material present in the concentrated sample analysed.

## RESULTS

### Concentration of binding proteins.

The results of adsorbing the binders onto calcium phosphate gel, and subsequent liberation into phosphate buffer, are shown in Table 4.2. At the recommended figure of 3 mg gel per mg protein, which represented an

Ca PO <sub>4</sub> per mg protein	Sample assayed	B12 binding activity present
3 mg	Original medium	438 ng l <sup>-1</sup>
	Treated medium	345 ng l <sup>-1</sup>
	0.02 M buffer	85 ng l <sup>-1</sup>
	0.1 M buffer	47 ng l <sup>-1</sup>
100 mg	Original medium	440 ng l <sup>-1</sup>
	Treated medium	111 ng l <sup>-1</sup>
	0.02 M buffer	112 ng l <sup>-1</sup>
	0.1 M buffer	100 ng l <sup>-1</sup>

Table 4.2 The B12 binding capacity present in filtered original, and calcium phosphate gel treated, D.primolecta medium, and in the phosphate buffers used to elute binder from the gel.



Concentration method	Concentration factor	Original B12 binding (ng l <sup>-1</sup> )	Treated B12 binding (ng l <sup>-1</sup> )	% binding retained
Ultrafiltration	x 9.6	598	75	12.5
Aquacide IV	x 11.0	526	59	11.2
Aquacide IV *	x 11.0	513	109	21.2
Sucrose dialysis	x 5.0	534	490	91.8

Table 4.3 The proportion of B12 binding activity in filtered medium of D.primolecta and P.lutheri (\*), retained after various concentration techniques and dilution to original volume.

extremely small volume of gel, only around 25% of binding activity was adsorbed onto the gel. Therefore, the ratio of 100 mg gel per mg protein was tried. Although in this case 75% of B12 binder became adsorbed, elution into the ionic buffer only released between 23% and 26% at each stage. This method was therefore clearly unsuitable.

Table 4.3 shows the proportions of B12 binding activity retained after concentration by ultrafiltration, addition of aquacide IV and sucrose dialysis. Only this last method retains the majority of the binding protein (91.8%), while the two more sophisticated techniques retain only 11.2% to 21.2% of original activity. Concentration against sucrose, with subsequent dialysis against PS buffer to remove sugar contamination, was therefore adopted as the method for reducing sample volumes.

Development of the affinity chromatography procedure.

The efficiency of APC coupling to sepharose 4B was found to be 90.8%, giving 4.82  $\mu\text{mol}$  of vitamin  $\text{ml}^{-1}$  gel. Coupling to affi gel 10 was 61.7% efficient, equivalent to 3.09  $\mu\text{mol}$   $\text{ml}^{-1}$  gel. Both these figures compare very favourably with the 20% coupling efficiency (1  $\mu\text{mol}$  of APC  $\text{ml}^{-1}$ ) obtained with sephacryl S200 (Jacobsen et al. 1981).

The results of the initial trial using an affinity column of APC-sepharose 4B are given in Table 4.4. With 70% of B12 binding protein being retained on the column, and only a small effect of flow rate apparent, the basic technique was clearly satisfactory.

The data obtained from the comparison of affi gel 10 and sepharose 4B as affinity matrices is shown in Table 4.5. Again, protein binding efficiencies around 70% are demonstrated, although there is little relationship shown between flow rate and binding efficiency. The lower than expected recoveries at 25 ml hr<sup>-1</sup> flow rates may be due to the fact that binder containing medium was first pumped through the column at the higher flow rates. Thus some APC binding sites, particularly those most accessible, would already be occupied. However, the lower binding figures at 100 ml hr<sup>-1</sup> cannot be readily explained, except by experimental error. Most importantly though, protein recovery using both matrices is efficient, even at high flow rates. As shown in the last column of Table 4.5, binding per  $\mu\text{mol}$  available APC was significantly more efficient to APC-affi gel 10. A further factor was that during the photolysis procedure, it was found that only 2 photolysis steps were required to release > 99% of the APC coupled to affi gel 10, whereas 3 photolyses were required to release 98% from sepharose 4B. APC-affi gel 10 was therefore adopted as the affinity

Table 4.4 The effect of flow rate through an APC-sepharose 4B column on the recovery of D.primolecta extra-cellular binding protein.

Flow rate (ml hr <sup>-1</sup> )	B12 binding capacity in eluate (ng l <sup>-1</sup> )	% binding efficiency
50	223	73
100	248	70
200	265	68
Original extract	827	—

Table 4.5 A comparison of the binding efficiency of D.primolecta EBP to APC-affi gel 10 and APC-sepharose 4B affinity columns at varying flow rates.

Support	Flow rate (ml hr <sup>-1</sup> )	B12 binding in eluate (ng l <sup>-1</sup> )	% binding efficiency	B12 binding (ng l <sup>-1</sup> / $\mu$ mol APC)
Affi gel 10	25	343	68	82.1
	50	300	72	87.0
	100	397	63	76.1
	200	355	67	80.9
Sepharose 4B	25	287	73	56.5
	50	196	82	63.5
	100	380	65	50.3
	200	326	70	54.2

Table 4.6 The effect of temperature on binding efficiency of D.primolecta EBP to APC-affi gel 10 by continuous flow and batch mixing methods.

Method of contact	Contact time	Temp. (oC)	% binding effic.
200 ml hr <sup>-1</sup> continuous flow through column.	0.03 hr	4	< 1
	0.03 hr	23	67
Batch mixing.	1 hr	4	54
	1 hr	23	79

matrix.

The results of the final trials of this affinity chromatography system, to determine the effect of temperature on protein binding efficiency and to evaluate the batch mixing procedure, are shown in Table 4.6. Using a continuous flow rate of 200 ml hr<sup>-1</sup> through an APC-affi gel 10 column at 4°C, the recovery of the proteins from the medium was negligible. However, the use of batch mixing, resulting in a much longer contact time, was highly successful. Although a significant reduction in binding efficiency at 4°C in comparison to room temperature is shown, the use of longer contact times facilitated the recovery of the majority of B12 binding protein.

Separation of free and protein-bound cobalamin.

Plate 4.1 shows the trace obtained when free cobalamin was separated from the complexed protein on a G-75 column, collecting 2.45 ml fractions. The binder complex comes off in the void fractions 8 and 9, while the vitamin derivative elutes between fractions 18 and 23. The separation was therefore complete and efficient.

However, Table 4.7 demonstrates that a proportion of B12 binding activity is lost when run on sephadex columns.

Plate 4.1 Elution monitored at 277 nm from a sephadex G-75 gel filtration column showing the separation of a binding protein sample complexed to APC (first peak, A=0.2) from unbound APC (second peak, A=1.0).

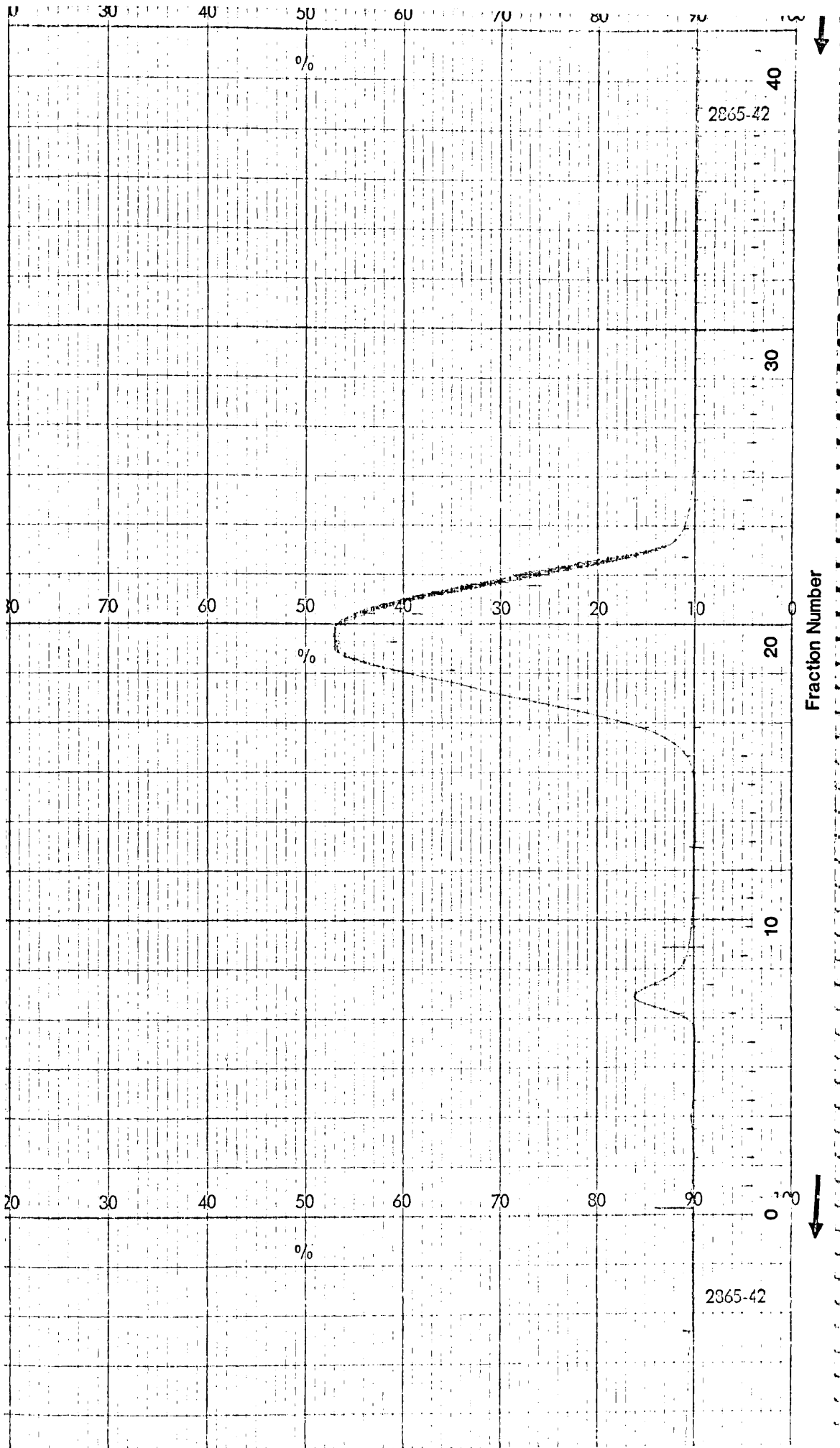

Matrix tested	Original B12 binding (ng l <sup>-1</sup> )	B12 binding after incubation (ng l <sup>-1</sup> )	% original binding capacity
G-75	298	232	77.9
G-200	298	218	73.1

Table 4.7 The effect of incubating filtered P.lutheri medium with sephadex gel filtration matrices after applying a correction factor for the void volume.



Method of protein assay	Estimated quantity of protein
Absorption 260/280 nm	147 $\mu$ g
CBB dye binding	13.6 $\mu$ g
Amino acid analysis	24.9 $\mu$ g

Table 4.8 The quantity of purified D.primolecta extra-cellular binding protein as estimated by three different methods.

Estimation of purified binding protein concentration.

Table 4.8 shows the quantity of D.primolecta extracellular binding protein as determined by A<sub>260/280</sub>, CBB dye binding and amino acid analysis. Clearly there is substantial variation, which is considered in the discussion. However, it was found in estimations of other D.primolecta samples by A<sub>260/280</sub> and CBB dye binding methods that the ratio of results obtained by these techniques was relatively constant at about 10:1. This enabled A<sub>260/280</sub> measurements to be used to give a comparative estimate of binding protein quantities.

#### DISCUSSION

The figure for protein concentration obtained from amino acid analysis is considered to be the most accurate, as it represents a direct measurement of the protein components. However, it was obviously not practicable to use this destructive method for regular estimations.

Estimation of protein concentrations by CBB dye-binding has been found to be extremely sensitive, but shows considerable variations in response to different

proteins (Van Kley and Hale 1977; Read and Northcote 1981). This could well have produced the apparently low values obtained if the binding proteins did not respond strongly to this assay. The dilute protein solution assayed may also have contributed to these inaccuracies.

It is apparent that assay of binding protein concentration by  $A_{260/280}$  measurements produced considerable over-estimations, 5 to 6 times the figure obtained from amino acid analysis. It is thought that the presence of bound cobalamin and the application of correction factors, resulting in an indirect measurement of the protein present, may have been a major cause of the high values.

However, the relatively constant ratio between the values obtained by the different methods meant that reliable, non-destructive estimates of binding protein concentration could be made, using absorbance measurements.

Although sucrose dialysis was found to be by far the most suitable method of those investigated for concentrating binders, it had the disadvantage of requiring a further series of dialyses against PS buffer. This was due to the fact that the cellulose dialysis tubing used was permeable to the sucrose, which became solubilised during dialysis, and therefore infiltrated the protein sample. An alternative would

have been to perform the concentration by dialysis against a high molecular weight material such as sephadex or aquacide III, which would absorb the water and to which the dialysis tubing would be impermeable. The results obtained when attempting to concentrate the binding protein by ultrafiltration or the addition of aquacide IV suggest that these proteins may have unusual properties, in particular a tendency to bind non-specifically. This is supported by the observed binding to sephadex matrices. Apparently, such binding occurs readily and in significant amounts. This was of considerable importance to the development of the purification scheme.

Apart from this tendency to bind non-specifically during procedures commonly used during purification, several other problems were known to exist. When attempting to purify B12 binding proteins from E.gracilis, Daisley (1970) found a tendency for the constituent sub-units to disaggregate during handling and storage. In addition, precipitation with trichloroacetic or perchloric acids, and dialysis against phosphate buffered urea or guanidinium chloride, were found to interfere markedly with vitamin B12 binding capability. It was therefore necessary to handle the binders with extreme care, avoiding any harsh reactions conditions, and to minimize the number of purification steps. A further complication was the

low concentrations of B12 binding protein found in algal media.

Therefore, the single step affinity chromatography procedure, recovering over 70% of B12 binding capacity, was considered eminently suitable. The basis of this method is shown diagrammatically in Figure 4.2. The high recoveries maintained when using higher flow rates at room temperature enabled the large volume of extracellular medium to be processed successfully. It was not possible to use flow rates above 200 ml hr<sup>-1</sup>, as this would have exceeded the maximum operating flow rate, but this figure sufficed quite adequately for the volumes used.

A somewhat surprising discovery was the drastically reduced binding efficiency at 4°C, as the work of Davies and Leftley (1985) shows the high affinity of algal binders for vitamin B12. However, this was overcome by running the affinity column at room temperature for the extracellular medium, with sodium azide added to prevent contamination and consequent clogging. For the intracellular and membrane-bound extracts, which could be resuspended in a convenient volume of buffer, batch mixing for 16 hrs at 4°C was most satisfactory.

These methods enabled B12 binding proteins from all three fractions to be purified following a single harvesting. The detailed procedures developed and

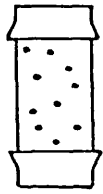

Immobilise the affinity ligand , aminopropyl cobalamin (APC) on affinity support.

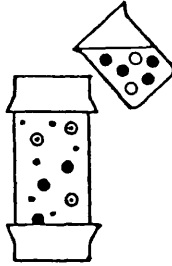

Apply medium or cell extract containing binding protein to column. APC specifically binds B12 binding proteins.

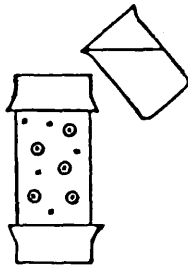

Wash column to remove extraneous proteins.

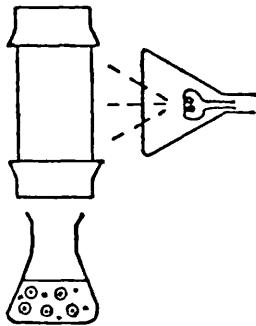

Photo-irradiate column to release binding protein bound to cobalamin and free cobalamin.



Separate purified binding protein from free cobalamin by gel filtration on sephadex G-75.

Figure 4.2 A diagrammatic representation of the purification scheme developed for algal B12 binding proteins.

finally adopted were as follows:

1) A column of APC-affi gel 10, containing cobalamin equivalent to approximately 100 times the B12 binding capacity of the sample to be purified, was packed under gravity and equilibrated with 50 ml PS buffer.

2) Medium containing the binding protein, with sodium azide added, was pumped through the column at 23°C and flow rates up to 200 ml hr<sup>-1</sup>.

3) When pumping was complete, the column was washed with 200 ml PS buffer at 200 ml hr<sup>-1</sup> to remove extraneous proteins and any other unwanted material.

4) The column was irradiated with tungsten filament and fluorescent illumination for 30 min under cooling. The cobalamin and bound material in the column was pumped out and collected. The complete step was then repeated.

5) The material collected from the column was concentrated by sucrose dialysis to approximately 1 ml, then run on a G-75 column at 40 ml hr<sup>-1</sup>. The fractions containing the void volume i.e. protein material, were collected and re-concentrated by sucrose dialysis.

6) The resultant material was exhaustively dialysed against PS buffer, before freeze-drying and storage at -20°C.

Note: All procedures up until stage 4) were conducted under dim red safe light illumination.

This continuous flow method was used as standard for the extracellular fraction. Intracellular and membrane-bound fractions were normally processed in parallel by batch mixing using a similar method with the following variations:

- 1) The affinity matrix was contained in a darkened glass, stoppered reagent bottle.

- 2) The sample was mixed with the matrix for 16 hrs at 4°C, then the gel collected by centrifugation at 700g.

- 3) The gel was washed 6 times with PS buffer, before being photolysed and separated on G-75.



CHAPTER 5 - CHARACTERISATION OF THE ALGAL  
VITAMIN B12 BINDING PROTEINS.

INTRODUCTION

One of the main objectives of this investigation of vitamin B12 uptake by unicellular algae was to elucidate the nature and possible role of the binding proteins produced. It was therefore clearly necessary to obtain detailed information regarding their characteristics and properties. This would allow any similarities and relationships between the proteins produced by an organism to be examined, and also allow a comparison between species. It was also hoped to shed light on the mechanism of the uptake process itself by determining the number and nature of the proteins involved.

To this end, isolation and purification procedures had been developed to facilitate characterisation of the purified binders. However, the small quantities of purified binding protein found to be produced represented a considerable limitation. This problem had also been encountered by Daisley (1970). This was therefore a major factor in the characterisations carried out.

## MATERIALS AND METHODS

Preparation of purified protein samples.

15 litres of D.primolecta and P.lutheri were grown axenically in 3 x 5 litre aerated cultures. They were harvested upon reaching stationary phase, and extracellular, intracellular cytosolic and membrane-bound fractions isolated as described in Chapter 3.

B12 binding proteins were purified from each fraction, using the system developed in Chapter 4. They were then dialysed exhaustively against distilled H<sub>2</sub>O at 4°C, freeze-dried in approximately 0.75 ml, and stored at -20°C prior to characterisation.

Estimation of native molecular weight.

This was carried out by gel filtration on an 81 x 1.6 cm column of sephadex G-200. Samples were run at 4°C in 1 ml PS buffer, at a flow rate of 15 ml hr<sup>-1</sup>, collecting 50 drop fractions equivalent to 2.39 ml. Outflow was monitored at 277 nm, using an absorbance range of 0.02 for binding protein samples, and 0.2 for standard samples.

The column was precalibrated using 5 mg purified samples of cytochrome C (MW=12 500), bovine serum albumin (MW=67 000), aldolase (MW=158 000), catalase

(MW=240 000) and thyroglobulin (MW=669 000). 1 ml blue dextran and aquacobalamin solutions were also used to determine the void and column volumes respectively.

D.primolecta binding proteins were dissolved in 1 ml PS buffer from the freeze-dried state for determination. In order to conserve as much material as possible, P.lutheri proteins were run on the G-200 column directly after collection from the affinity column, and concentration to 1 ml i.e. with the free cobalamin present. This effectively performed separation and molecular weight determination in a single step. In addition to giving a figure for native molecular weight, gel filtration also provided an indication of homogeneity.

After all the purified protein samples had been run on the G-200 column, it was used to confirm the values obtained for the binders as follows: crude extracellular, intracellular and membrane-bound extracts were prepared and concentrated 10 times to increase the B12 binding capacity of the samples. 1 ml of each concentrated extract was then incubated with 2.27  $\mu\text{g}$   $^{57}\text{Co}$  B12 for 1 hr at room temperature, to allow the binders to complex with the radioactive vitamin. This sample was then run on the G-200 column as previously described, and fractions collected and counted in an LKB Mini-Gamma counter to determine the radioactivity present.

Determination of sub-unit composition.

As the native protein molecular weight was found to be well in excess of that for a single polypeptide chain, SDS polyacrylamide gel electrophoresis was investigated as a method of estimating sub-unit size, and to confirm sample homogeneity.

16.2% acrylamide gels were prepared with the following composition:

5.4 ml 40% acrylamide, 1% bis-acrylamide

5.0 ml 1 M Tris/HCl pH 8.8

1.3 ml 1% sodium lauryl sulphate (SDS)

0.6 ml 1.5% ammonium persulphate

1.0 ml H<sub>2</sub>O

1 drop 10% TEMED.

75 x 5.5 mm rods were set at room temperature for 1.5 hr, then used immediately.

Standard samples were prepared with equal volumes of protein solution, 1% SDS, 1 M tris/HCl pH 8.8, 50% glycerol and dilute bromophenol blue to mark the migration front. These solutions were also warmed with mercaptoethanol in a hot water bath for 15 min prior to use, to ensure total dissociation. Freeze-dried D.primolecta extracellular binding protein was dissolved in 2 drops of a solution containing equal volumes of 1% SDS, 1 M tris/HCl pH 8.8 and dilute

bromophenol blue in 50% glycerol, with 20% mercaptoethanol added, and warmed for 15 min.

1 drop of standard protein samples and 2 drops of the binding protein sample, representing 142  $\mu\text{g}$  as estimated by  $A_{260/280}$ , (25.8  $\mu\text{g}$  nominal), were loaded onto the gels. These were run at a constant 3 mA per rod, equivalent to approximately 80 V. The reservoir buffer contained 14.4 g glycine, 3.1 g tris and 1.0 g SDS per litre. Gels were removed after 1.25 hrs, then fixed and stained for 18 hrs with coomassie brilliant blue R-250 (2.5 g  $\text{l}^{-1}$ ) in 40% methanol and 7% glacial acetic acid in  $\text{H}_2\text{O}$ . Destaining was with the same solvent.

#### Analysis of amino acid composition.

Around 50  $\mu\text{g}$  of purified extracellular, intracellular and membrane-bound B12 binding proteins, as estimated by  $A_{260/280}$  measurements, from both D.primolecta and P.lutheri were analysed for amino acid constituents. Freeze-dried samples were dissolved in 0.7 ml 6 M HCl, and hydrolysed in evacuated glass tubes for 20 hrs at  $110^\circ\text{C}$ . The HCl was then removed by freeze drying.

Samples were taken up into 0.7 ml 0.2 M sodium citrate buffer, and loaded onto an LKB 4101 amino acid analyser. 0.5 ml was separated on a 30 x 0.6 cm

sulphonated polystyrene cation exchange resin column at 52°C. This was pre-equilibrated for 45 min, then fractionation performed using the following sequence of sodium citrate buffers :

- A) pH 3.25, 0.2 M for 10 min.
- B) pH 4.25, 0.2 M for 45 min.
- C) pH 6.45, 1.2 M for 70 min, OR  
pH 5.28, 0.3 M for 165 min.

The temperature was raised to 70°C after 42 min run time.

The pH 6.45, 1.2 M buffer C was used for an initial analysis of an estimated 147 µg D.primolecta EBP sample. Subsequently, the latter buffer was used to improve the separation of basic amino acids.

A 25 nM amino acid standard sample was run after each binding protein analysis. The area of each amino acid peak was determined, and the amount present in the binding protein sample calculated by comparison with the 25 nM standard.

Investigation for carbohydrate components.

A highly sensitive method of analysing for the presence of any carbohydrate moiety in the binders was developed using immobilised lectins. A range of lectins, which specifically bind the carbohydrates and amino-sugars commonly found in glycoproteins, were

obtained immobilised on inert agarose gel substrates. These included Concavalin A (BDH), RCA<sub>120</sub> (BDH), Lotus agglutinin (Sigma) and Glycine max agglutinin (Sigma). 850  $\mu$ l of extract containing B12 binding protein was mixed with 150  $\mu$ l of immobilised lectin gel for 2 hrs at room temperature, then 16 hrs at 4°C. The gel was removed by centrifugation and the B12 binding capacity of the original extract was compared with that of the treated samples by ultrafiltration assay. Thus any loss of B12 binding capacity, resulting from the binding of a carbohydrate moiety in the protein to lectins, could be determined. A correction factor due to dilution of the samples by the volume of gel was calculated and applied to the results.

## RESULTS

Estimation of native molecular weight.

The calibration graph obtained when pure protein samples were run on the G-200 column is shown in Figure 5.1. Aquacobalamin eluted in the column volume of 163 ml. A linear relationship is shown for molecular weights between approximately 10 000 and 500 000. Molecules larger than this travel in the void volume. Catalase, however, shows a small deviation from

linearity. This is thought to be due to a tendency to adsorb to gel filtration matrices, thereby increasing retention time.

The purified B12 binding proteins obtained from D.primolecta and P.lutheri all travelled in the void volume, eluting at around 64 ml. A sample trace of D.primolecta EBP is shown in Plate 5.1. It should be noted, however, that the peak recorded for P.lutheri IBP was very small, and was only 1.8 times the maximum variation in the base line. It would appear, therefore, that these algal B12 binders are very large molecules, with a molecular weight probably in excess of 500 000.

These results were confirmed by the experiments running <sup>57</sup>Co B12 labelled binders on the G-200 column. In each case, a substantial peak of radioactivity was recovered in the void fractions, while the majority of the remainder came off in the column volume. The first peak, therefore, represented radioactive B12 complexed with the binding protein, while the second was due to unbound vitamin.

Similar findings for the molecular weight of B12 binders from E.gracilis were reported by Daisley (1970).



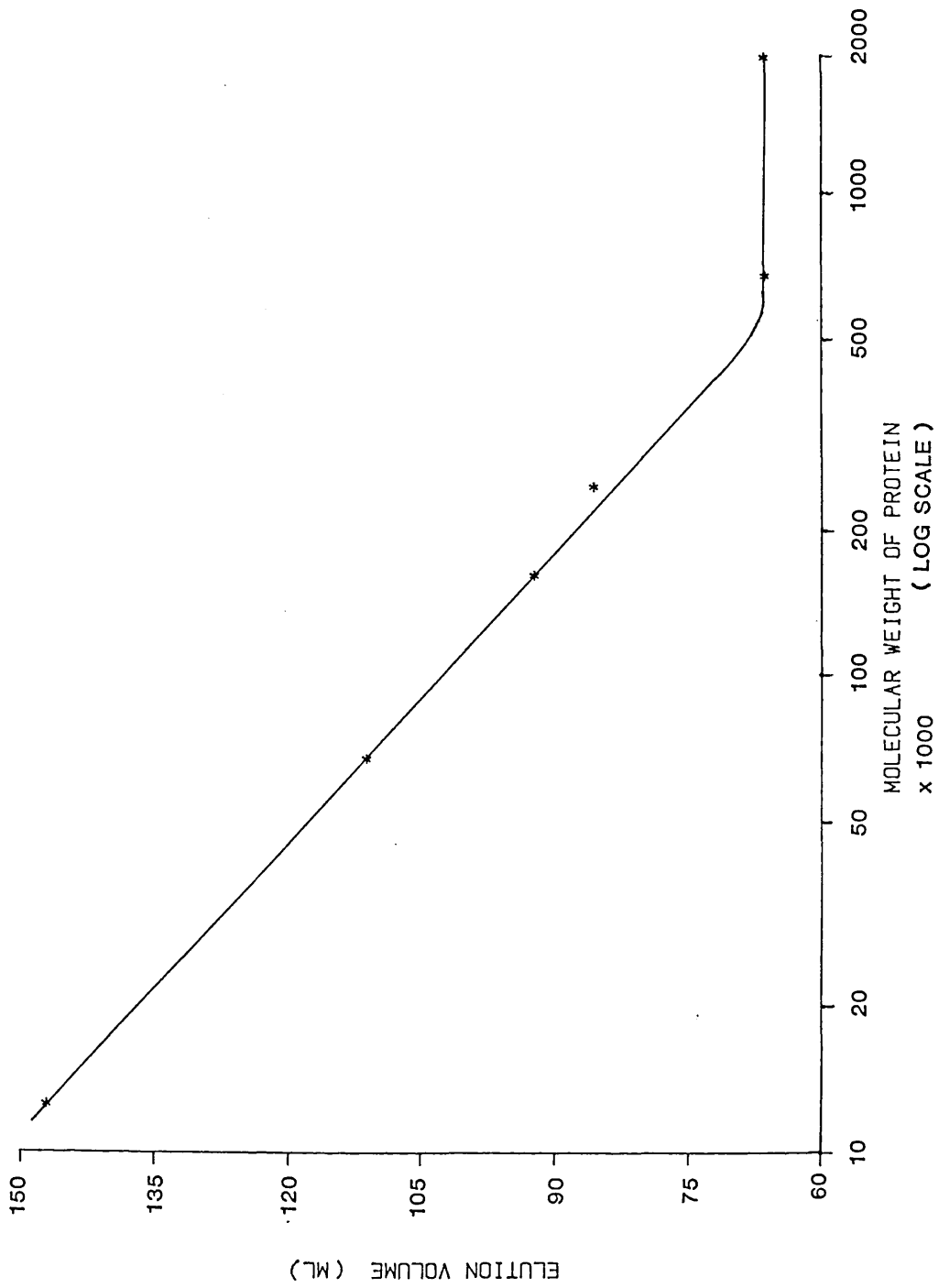
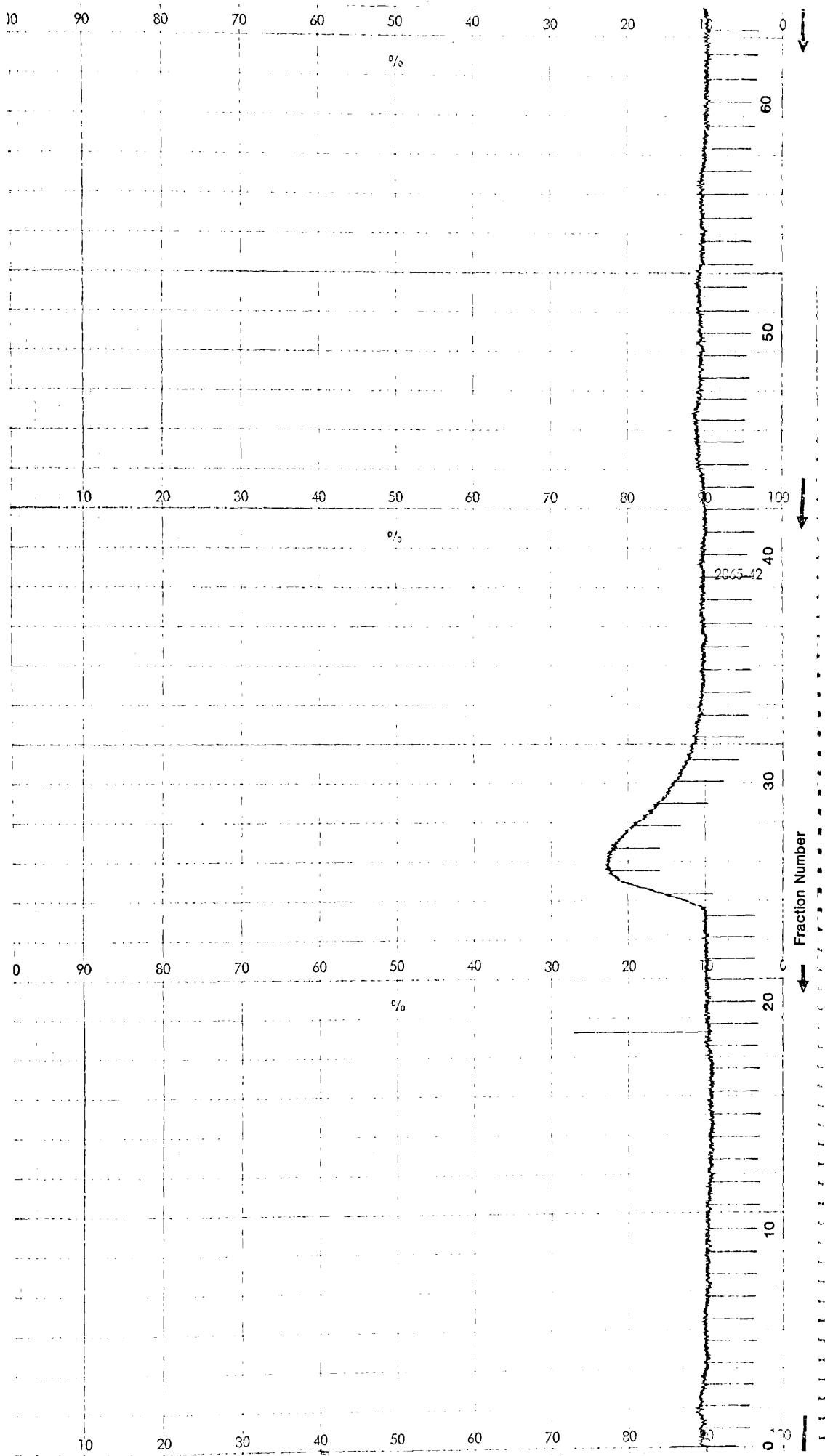

Figure 5.1 The calibration curve obtained when running standard proteins on a 81 x 1.6 cm sephadex G-200 gel filtration column.

Plate 5.1 Elution of a purified D.primolecta extra-cellular binding protein sample from a sephadex G-200 gel flitration column, monitored at 277 nm with an absorbance range of 0.02 and collecting 2.39 ml fractions.



SDS polyacrylamide gel electrophoresis.

Experiments with a range of standard protein samples, with loadings between 44 and 200  $\mu\text{g}$ , showed the technique to give a reliable estimation of constituent molecular weight. Plate 5.2 shows gels run with a Dalton Mark VII-L standard mixture (Sigma) containing a range of 7 calibration proteins, ovalbumin with a 44  $\mu\text{g}$  loading, and the D.primolecta EBP sample nominally representing 25.8  $\mu\text{g}$ .

The standard proteins gave clearly defined bands. However, no band could be detected for the binding protein sample. This could be due to insufficient loading, a problem which was almost certainly compounded by a poor response to the coomassie brilliant blue dye, as already observed with the quantitative protein assay technique.

Analysis of amino acid composition.

The amino acid analysis obtained from an initial sample of 147  $\mu\text{g}$  D.primolecta EBP is shown in Plate 5.3. The 25 nM standard is shown in Plate 5.4. This enabled the amino acid composition of the binder sample to be calculated, and this is given in Table 5.1.

However, the limited quantities of the purified binders subsequently available for analysis resulted in

Plate 5.2 SDS electrophoresis of sample proteins on polyacrylamide gels.

A 25.8  $\mu\text{g}$  (nominal) D.primolecta EBP,

B 44  $\mu\text{g}$  ovalbumin,

C Dalton Mark VII-L standard mixture containing 7 calibration proteins.

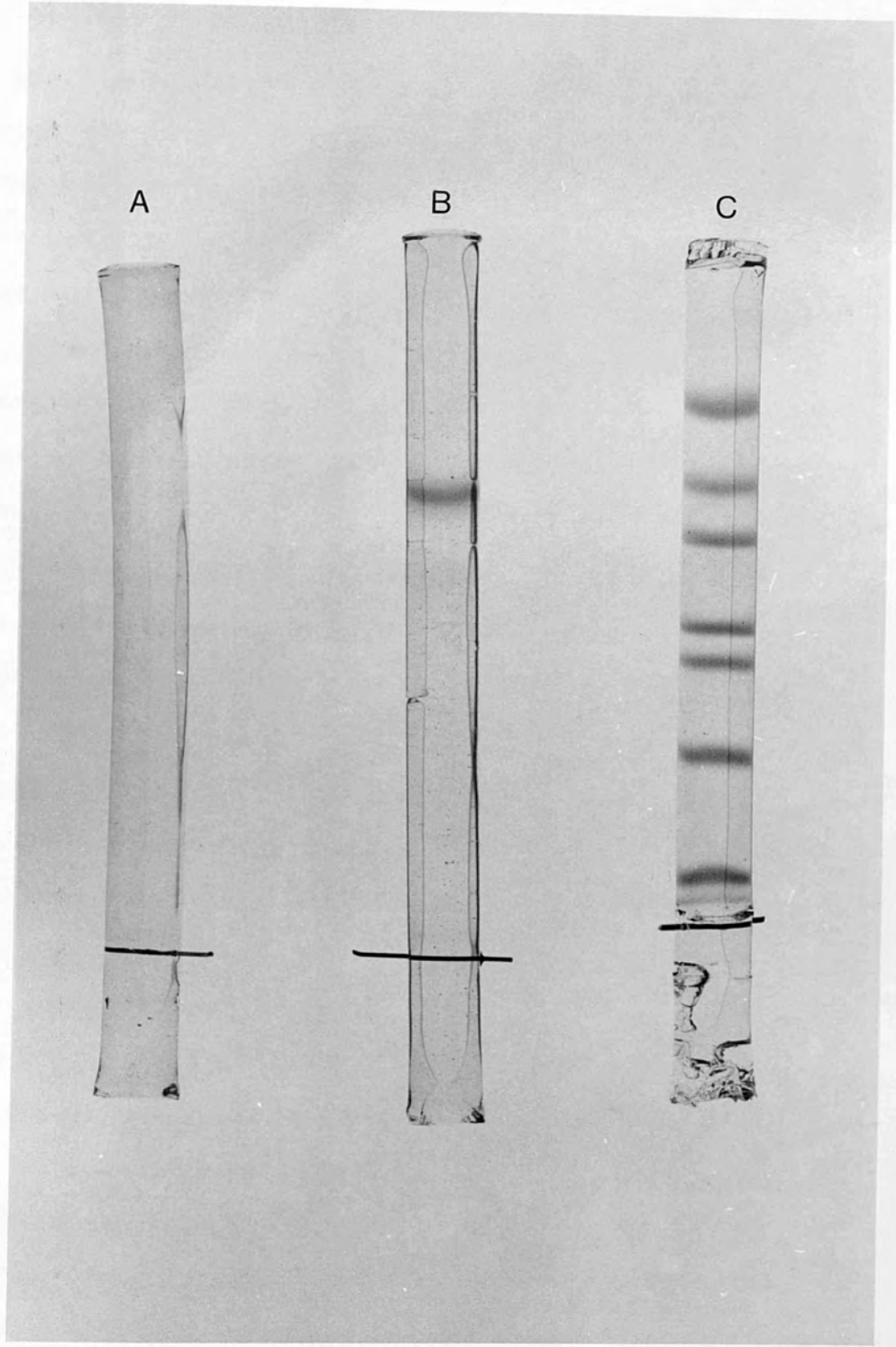

very small peak sizes. (See Plate 5.5). This precluded a meaningful determination of total amino acid composition. However, it was possible to obtain a comparison of the binding proteins by analysing the ratio of the amounts of amino acids which separated adjacent to each other. Three pairs of adjacent peaks were considered: threonine and serine, glycine and alanine, leucine and isoleucine. The relative quantities of these amino acids present in the B12 binding proteins of D.primolecta and P.lutheri are given in Table 5.2.

Although some small variations are shown, these are probably due to the small quantities analysed, and the overall pattern of amino acid ratios demonstrated is similar for all the proteins. Thus, not only do the extracellular, intracellular and membrane-bound binding proteins produced by each species appear to be similar, but this similarity is also shown between the binders of D.primolecta and P.lutheri. Of particular note is the consistent ratio of glycine to alanine, of around 1.8 to 1, as of the two alanine is generally found in greater amounts in proteins. The three amino acid ratios demonstrated in the six smaller samples are similar to those calculated from the complete analysis of D.primolecta EBP. This suggests that these analyses are valid and therefore represent a meaningful comparison of the binders.

Plate 5.3 Amino acid analysis of an estimated 147  $\mu\text{g}$  sample of D.primolecta extracellular binding protein using the 125 minute separation system.



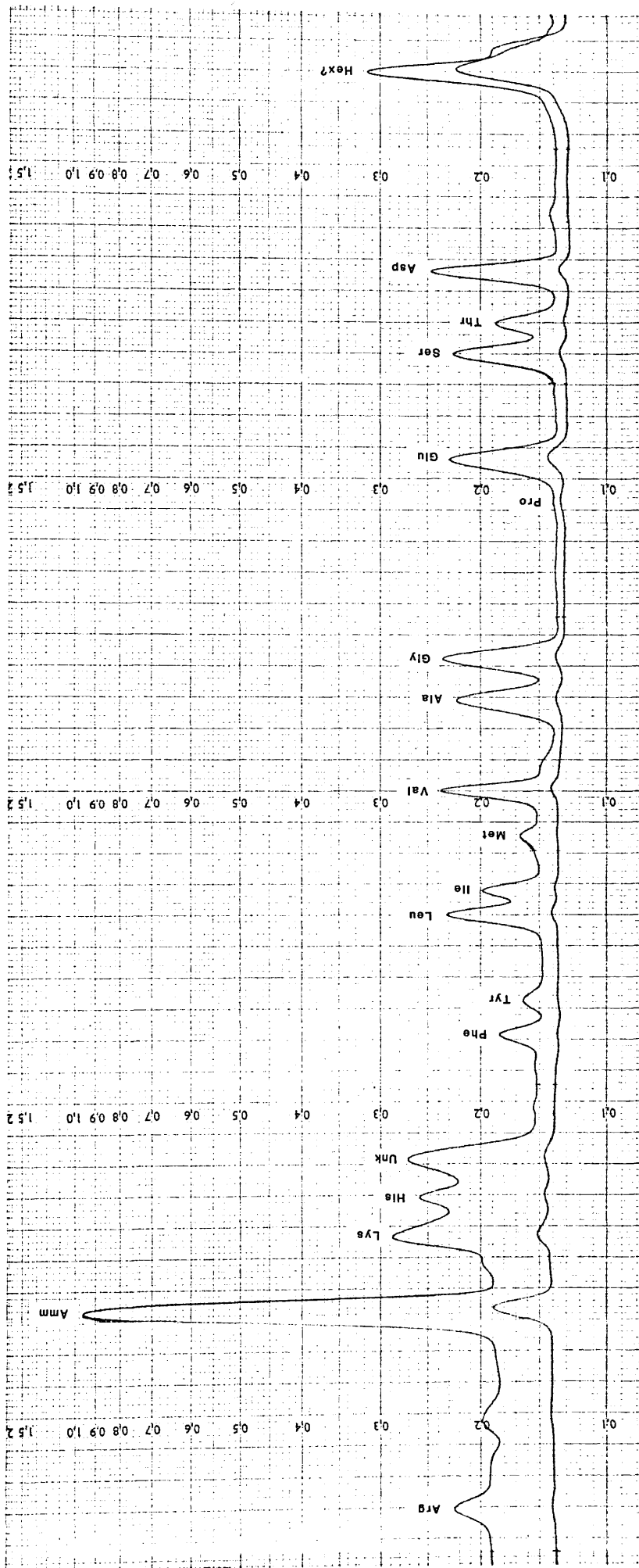

Plate 5.4 Amino acid analysis of a 25 nM standard  
using the 125 minute separation system.

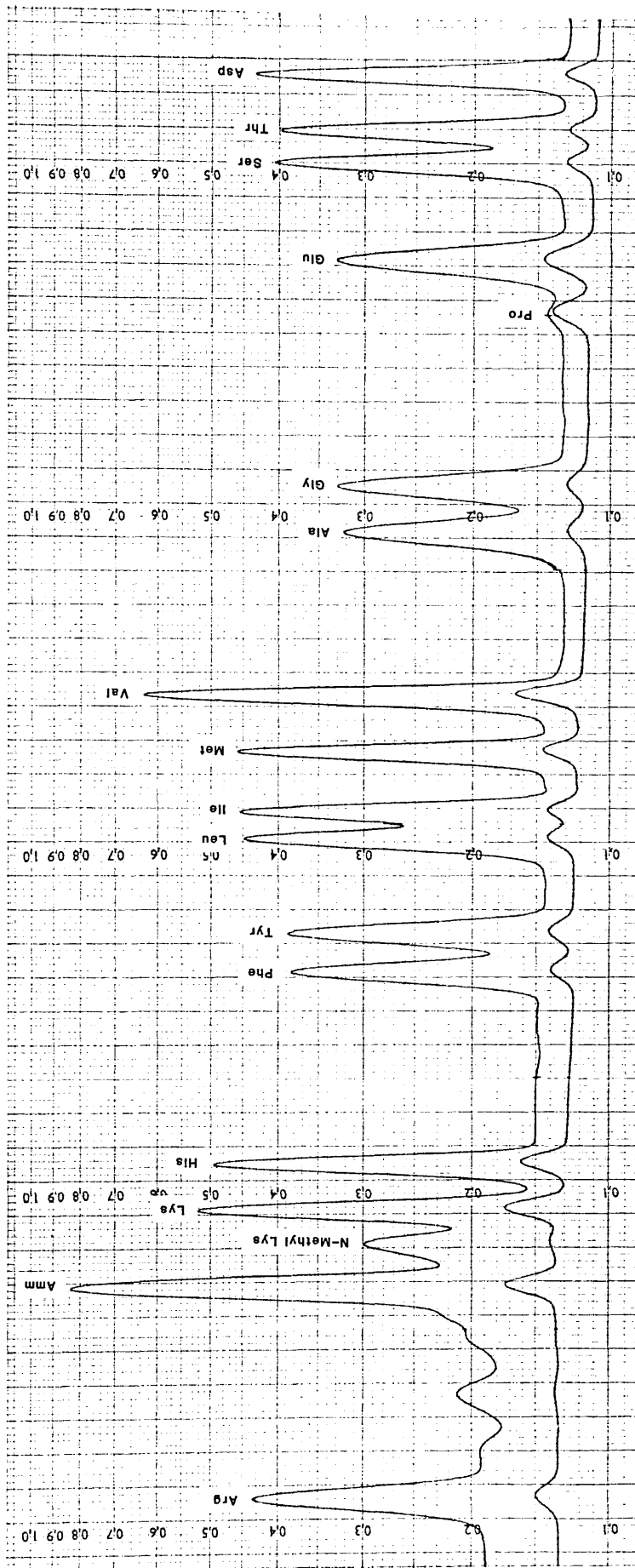
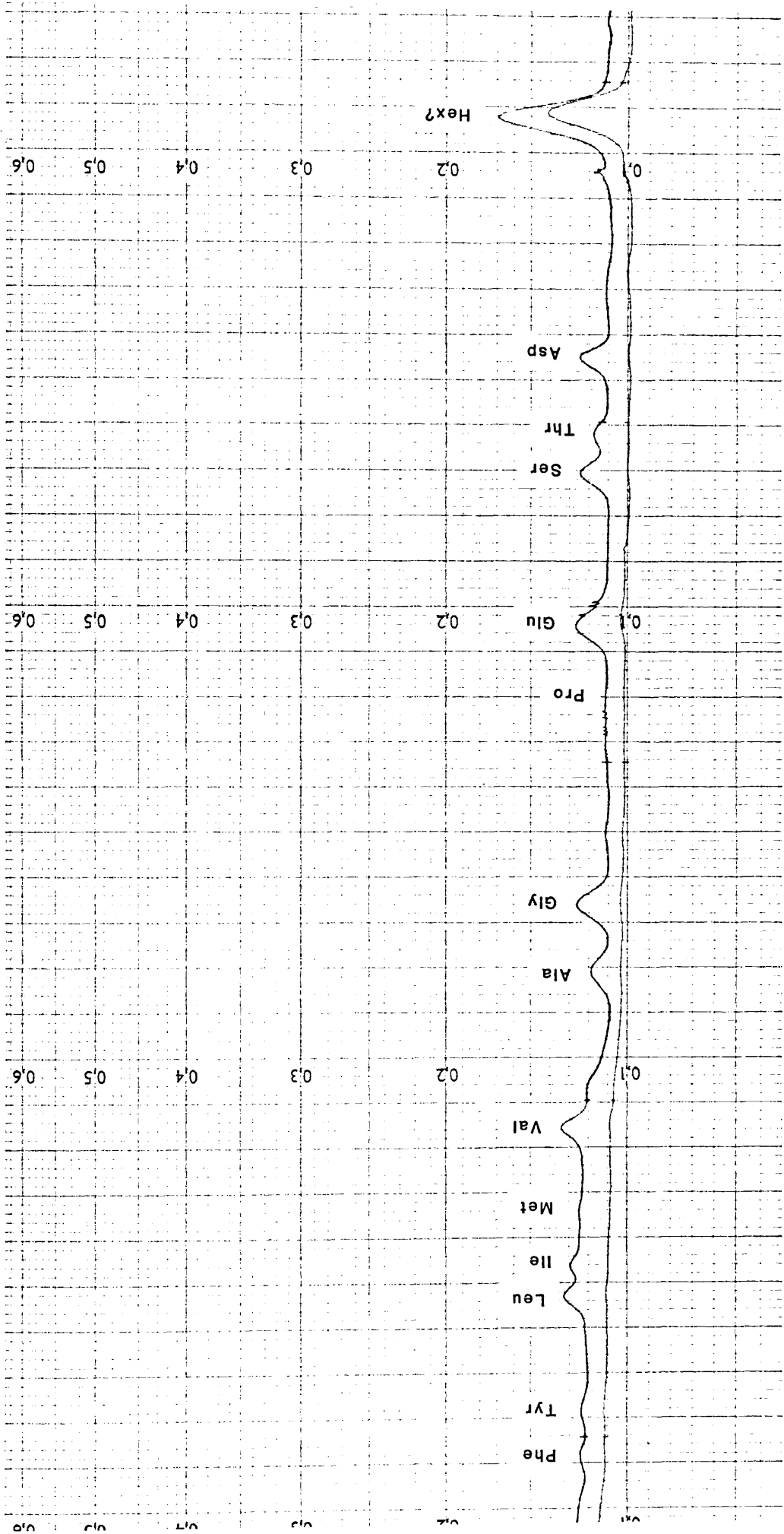

Plate 5.5 Amino acid analysis of a typical purified binding protein sample using the 220 minute separation system, showing the small peak sizes obtained.



Amino acid	Concentration (nM)	% composition
Aspartic acid	10.76	10.34
Threonine	5.78	5.55
Serine	9.76	9.38
Glutamic acid + Glutamine	10.36	9.95
Proline	3.15	3.03
Glycine	12.32	11.84
Alanine	10.96	10.53
Valine	5.09	4.89
Methionine	1.56	1.50
Isoleucine	4.54	4.36
Leucine	6.81	6.54
Tyrosine	1.33	1.28
Phenylalanine	3.09	2.97
Histidine	7.06	6.78
Lysine	8.19	7.87
Arginine	3.32	3.19

Table 5.1 The amino acid composition of D.primolecta extracellular binding protein.

Amino acid ratio	D. primolecta proteins			P. lutheri proteins		
	EBP	IBP	MBP	EBP	IBP	MBP
Thr / Ser	0.56	0.34	0.51	0.56	0.34	0.40
Gly / Ala	1.77	2.00	1.97	1.89	1.65	2.02
Ile / Leu	0.76	0.80	0.75	0.55	0.77	0.66

Table 5.2 The ratios of the nM concentrations of amino acids found in the B12 binding proteins of D. primolecta and P. lutheri.

There were two further features of particular interest in the analyses. All the binders analysed showed the presence of an unidentified basic amino acid which, using the improved buffer separation system, came off between histidine and lysine and in similar quantities. On the shorter analysis, this peak appears just before histidine, and is labelled "Unk" on Plate 5.3. It is therefore a common feature of these binding proteins.

The other feature detected on all the binder analyses was a peak, labelled "Hex" on Plates 5.3 and 5.5, which came off the column before the first amino acid, in the region characteristic of hexosamines. The position of this peak was constant and, although variable in size, it was always considerably larger than the amino acid peaks. Initially it was thought that this peak might represent amino-sugars present in the binding protein sample, or alternatively could be derived from carbohydrate material eluted from the sephadex gel filtration columns.

Subsequently, as the amounts of binding protein analysed were small, it was considered necessary to check that the analysis was not significantly affected by contamination with extraneous protein material. Therefore, a sample of PS buffer which had been used to wash the G-200, and equivalent in volume to the combined fractions in which binding proteins were



recovered, was collected. This sample was concentrated, dialysed and freeze-dried using the same procedure as for the binders. It was then hydrolysed and analysed to determine whether the first peak detected was derived from the sephadex column, and also whether the procedures used had introduced any detectable amino acid contamination. The trace amounts of amino acids found in this sample were undetectable for any practical consideration. However, a peak in the same position as that observed with binding protein samples, although somewhat smaller, was found. It was therefore concluded that this peak was probably derived from the cross-linked dextran sephadex material.

Investigation for carbohydrate components.

Tables 5.3 and 5.4 show the carbohydrate binding specificities of the immobilised lectins, and the proportion of B12 binding retained by extracts of D.primolecta and P.lutheri respectively after incubation. Somewhat greater than normal experimental variations in the values obtained using the ultrafiltration technique were observed. This may be due to non-specific binding effects. However, most treatments resulted in no significant loss of B12 binding activity from the binder-containing extracts, suggesting that there were no carbohydrate components

Lectin	Carbohydrate specificity	% original B12 binding capacity retained extracellular   intracellular   membrane bound		
Concavalin A	Man, Glc, N-Ac-Glc	95.7	102.9	104.8
Lotus agglutinin	Fuc	98.9	96.8	83.4
RCA 120	Gal	106.3	101.6	71.0
Glycine max agglutinin	N-Ac-Gal	94.9	116.2	112.0

Table 5.3 The percentage B12 binding capacity of the three fractions isolated from D.primolecta retained after incubation with carbohydrate binding immobilised lectins.

Lectin	Carbohydrate specificity	% original B12 binding capacity retained extracellular   intracellular   membrane bound		
Concavalin A	Man, Glc, N-Ac-Glc	92.9	87.9	100.0
Lotus agglutinin	Fuc	100.0	85.7	87.3
RCA 120	Gal	89.9	94.3	84.5
Glycine max agglutinin	N-Ac-Gal	29.3	108.5	94.0

Table 5.4 The percentage B12 binding capacity of the three fractions isolated from P.lutheri retained after incubation with carbohydrate binding immobilised lectins.

in the proteins.

A highly significant reduction of 71% is shown in the B12 binding capacity of the extracellular fraction from P.lutheri cultures when incubated with Glycine max agglutinin. This is of the same order of binding efficiency as to the high affinity APC matrix, and suggests a highly specific interaction. It would therefore appear that P.lutheri EBP contains N-acetyl galactosamine moieties.

The D.primolecta MBP extract also shows a noticeable, but inconclusive, loss of 30% binding activity when incubated with RCA<sub>120</sub> which binds D-galactose residues.

#### DISCUSSION

Clearly the major problem encountered in the characterisation of algal B12 binders was the limited quantities produced. A maximum of 150 µg was available for each analysis.

This problem of small amounts of binder was also found by Daisley (1970) who was working with cellular and extracellular proteins purified from E.gracilis to give quantities around a milligram. Apart from poor yields, he also found the material to be non-homogeneous, and three bands were observed using

polyacrylamide gel electrophoresis. Varma et al. (1961) reported an attempt to purify cellular B12 binder from E.gracilis, but no results were produced. It would therefore appear that there are considerable problems of final yield and purity in attempting to characterise algal B12 binders, and this may account for the dearth of previous information on the subject. It was therefore hoped that the affinity chromatography procedure would overcome these difficulties and allow new information to be obtained on these binding proteins.

However, it was apparent from an early stage of characterisation that there would be insufficient amounts of material available for an investigation of possible carbohydrate constituents by paper or gas-liquid chromatography, as this would have required the hydrolysis of around 1 mg of purified protein. Therefore the highly sensitive immobilised lectin method, which could be used with the native binders, was developed.

Daisley (1970), using paper chromatography, had concluded E.gracilis B12 binders to be glycoproteins containing xylose, fucose and small amounts of hexosamines. It should be noted though that the presence of other non-binder material in the final extract may well have contributed to the carbohydrates found. Of the two organisms investigated here, only the

extracellular binder from P.lutheri appears to contain a carbohydrate component, namely N-acetyl galactosamine. However, it should be noted that no lectin binding xylose was available, and only the presence of the other commonly found sugars and hexosamines could be investigated.

The binding of a proportion of D.primolecta membrane-bound B12 capacity to RCA<sub>120</sub>, which binds galactose, cannot be straightforwardly interpreted. It is considered possible that forms of the protein both with and without associated carbohydrate were isolated from the membrane during extraction. It could also be that loss of B12 binding activity was due to the type of non-specific binding previously encountered. However, if this were the case, the other binders would have been expected to show similar effects, which are not so evident, although a substantial amount of experimental variation was demonstrated. This may therefore be the explanation.

The most valuable information was obtained from the determinations of the amino acid composition, and native molecular weight of the binding proteins. These demonstrated that all three binders, from both species, show highly significant similarities in the amino acids present, and their relative amounts. They are all large molecules, in excess of 500 000 M.W, and must therefore be composed of several constituent sub-units. It is

also possible that the binders readily form dimers or oligomers.

For comparison, Daisley (1970) found E.gracilis binding proteins also to have very high molecular weights, but the data obtained from amino acid analysis was somewhat different to that found for D.primolecta and P.lutheri. However, again the probable presence of other proteins could well have affected his analyses.

The initial amino acid analysis of the estimated 147 µg sample of D.primolecta EBP gave adequately sized peaks for a good determination of total composition. Unfortunately, due to an equipment failure and errors in experimental procedure, all the D.primolecta binding proteins used for amino acid analysis and molecular sieving, had to undergo additional dialysis and freeze-drying steps. The binders used for amino acid analysis also had to be rehydrolysed in HCl. It is thought likely that some material was lost at each stage, and that this largely accounted for the reduced quantities available for the later analyses.

The highly specific purification process and the elution of a single peak from the G-200 column suggest that the purified proteins were almost certainly effectively homogeneous. This is in contrast to the purification by Daisley (1970), which resulted in greater quantities of material, but poor homogeneity. Confirmation of purity, however, would require

polyacrylamide gel electrophoresis study.

In the event, SDS PAGE investigations were not continued as, with the loading available, no results could be obtained. This limitation, in common with that affecting the other characterisations, was due to the small quantities of binder available. Despite these problems, it is thought that all the analyses attempted could be carried out more fully using the methods developed in this study. This would involve the careful purification and handling of binders from a large culture, followed by a single characterisation on each sample. It would, therefore, require a considerable expenditure of time and materials. It is not considered practicable to carry out more detailed investigations such as peptide mapping which would require considerably greater amounts of purified protein, but limited further characterisation to provide additional information, such as the isoelectric point of the proteins by isoelectric focussing, should be possible.

Although the amount of information about algal B12 binding proteins obtained by their purification and characterisation was less than had been anticipated, it has permitted the elucidation of the major features of interest.

Firstly, it has been shown that there is almost certainly only a single species of B12 binding protein located in the cell membranes. Consequently, uptake of



the vitamin would appear to be a relatively simple process, and does not involve transfer to other proteins in the membrane. Also, it can be concluded that there is only one type of cell surface B12 receptor site operating.

Secondly, the extracellular and intracellular cytosolic binders are either very similar, or identical to, the membrane-bound protein and to each other. Therefore, in all probability, they are the product of the same gene, although there may be subsequent minor alterations. This in turn suggests that they did not evolve independently to perform a specific role, separate from that of the cell B12 uptake process. Any function now performed is most likely to represent either a chance by-product or an integral part of the main mechanism operating.

Finally, it is considered interesting that the binding proteins produced by different species are similar to one another. It is therefore quite possible that they share a common evolutionary origin, and therefore represent an extremely ancient process.

CHAPTER 6 - LOCALISATION OF CELLULAR B12

BINDING SITES.

INTRODUCTION

Intracellular B12 binding by algae was first found by Varma et al. (1961) in E.gracilis where at least 70% of B12 taken up was attached to sedimentable particles. However, a specific location was not identified.

In O.malhamensis, bound vitamin B12 has also been shown to be principally associated with particulate fractions (Reeves and Fay 1966). It was thought that B12 might be largely bound by mitochondrial, cell wall and ribosomal fractions, as found in a range of bacterial and mammalian cells. Sarhan et al. (1980) showed that the majority of B12 taken up by E.gracilis was located in the chloroplasts. This led them to suggest that the chloroplasts contained the principal binding sites for B12 and could be involved in uptake of the vitamin by the cell. However, subcellular localisation of cobalamin in the same organism (Isegawa et al. 1984) revealed that approximately half of the vitamin was associated with the cytosol. The mitochondria and microsomes, as well as the chloroplasts, bound the rest of incorporated B12.

Daisley (1970) found that antisera to the vitamin B12 binding proteins from E.gracilis did not

agglutinate the cells. There was therefore no evidence that these binders were a component of the cell wall or coat.

Clearly there are two main aspects of the location of algal B12 binding sites which are in doubt. Firstly, whether the initial cell receptor site is indeed in the cell wall or membrane, as might be expected, or whether it is associated with an intracellular structure. Secondly, the sub-cellular distribution of binding sites for the vitamin, and which organelles are principally involved.

It was hoped to discover these features by microscopically visualising the B12 binding sites in D.primolecta and P.lutheri.

#### MATERIALS AND METHODS

Immunocytofluorescent microscopy.

The principle employed was that of indirect immunofluorescence, using a rabbit antibody to B12 which would bind to the vitamin, and a sodium isothiocyanate fluorescein (FITC) labelled anti-rabbit serum to act as the luminescent marker.

Initially, fixation and bleaching of chlorophyll from the cells prior to immunofluorescent study was

attempted by the method of Vladimirova, Markelova and Semenenko (1982). This uses 96% ethanol to fix and bleach cells directly on the slide. However, poor preservation of cellular detail, as well as fluorescence from residual chlorophyll was found. The following procedure was therefore adopted. Cells were harvested by centrifugation at 500g and resuspended in 0.1 M phosphate buffer, pH 7.4. Fixation was in 3% glutaraldehyde in phosphate buffer for 1 hr, followed by washing. The cells were then passed through a series of 30%, 50% and 75% ethanol for 10 min each, then 95% for 30 min. Two or three drops of this suspension were air dried on a microscope slide and washed with phosphate buffer before use. (These preparations could be stored overnight at 4°C).

In the first immunocytological investigations, cells of D.primolecta grown in axenic culture with 15  $\mu\text{g l}^{-1}$ , and also with no added B12, were harvested in mid-logarithmic phase and fixed as above. The cells were covered with 2 to 3 drops of anti-B12 serum (RB12-101 kindly supplied by RIA) diluted x 100 with phosphate buffer, in a humid chamber for 30 min at room temperature. Excess serum was thoroughly washed off with buffer and the slide allowed to dry. The cells were then similarly incubated with a 50 x dilution of the FITC labelled antiserum (SWAR / FITC Nordic immunological laboratories) for 1 hr in the dark before

being thoroughly washed and mounted in phosphate buffer containing 10% glycerol. Subsequently a 10 x dilution of the anti-B12 and 5x dilution of the anti-rabbit serum were also used with this method.

Cells were observed on a Leitz Dialux 20 EB microscope under transmitted visible light, and incident ultraviolet illumination using the exciting filter BP 340-380 nm and LP 430 nm suppression filter. Micrographs were taken on an Olympus OM 2 camera containing Ilford FP4 film, downrated to ASA 64.

The second method of antibody treatment investigated used D.primolecta cells grown without B12, and a vitamin-antibody complex to bind to the cell B12 receptor sites. This complex was prepared by incubating 0.1 ml of diluted anti-B12 serum with a vitamin binding capacity of  $5 \mu\text{g ml}^{-1}$ , with 0.9 ml phosphate buffer containing 525 ng B12, for 1 hour at room temperature. Uncomplexed, free B12 was removed by ultrafiltration using the MPS apparatus. Freshly harvested, exponentially growing cells were incubated with  $50 \text{ ng ml}^{-1}$  of the complex in phosphate buffer for 10 min, to allow binding to the cell receptor proteins. The cells were then fixed and prepared onto slides before incubation with the FITC labelled antiserum as previously described. Control treatments, where the cells were incubated with the anti-B12 serum uncomplexed to the vitamin, were also prepared.

### Electron probe micro analysis.

This technique relies upon the principle that different elements emit characteristic wavelengths of X-radiation when bombarded with high energy electrons. This could prospectively be used to detect the central cobalt atom in the B12 molecule.

Cells from logarithmic phase grown with  $15 \mu\text{g l}^{-1}$  B12, and also without B12 as controls, were prepared for transmission electron microscopy and EPMA using the schedule given in Table 6.1. For certain preparations, step 3, involving fixation and staining with osmium tetroxide, was omitted.

Sections were cut approximately 70 nm thick (appearing silver-gold) using a glass knife and collected on 200 mesh copper grids. For initial observations they were counterstained in uranyl acetate for 30 min and lead citrate for 10 min, before observation in a Zeiss EM 109 transmission microscope. For EPMA studies, sections untreated with osmium tetroxide and not counterstained were examined by Zeiss U.K. using an EM 10C transmission electron microscope and a Link AN 10 000 energy dispersive X-ray analysis system.

- 1) Harvest cells by centrifugation at 700g and wash twice in 0.1 M phosphate buffer, pH 7.4.
- 2) Fix cells in 3% glutaraldehyde for 1 hour at room temperature and wash in 0.1 M phosphate buffer, pH 7.4.
- 3) Post-fix in 1% osmium tetroxide for 30 min at room temperature, then wash in distilled H<sub>2</sub>O.
- 4) Dehydrate through the following ethanol series for 10 min each: 30, 50, 70, 80, 90, 95 and 100 per cent, with 3 changes in the final absolute ethanol.
- 5) Transfer to propylene oxide for 15 min, with two changes.
- 6) Suspend in a 1:1 mixture of propylene oxide and araldite resin overnight.
- 7) Infiltrate with pure araldite for 5 hr, before final transfer to a beam capsule containing araldite.
- 8) Pellet cells by centrifugation at 500g and polymerise resin overnight at 70°C.

Table 6.1 The schedule used to prepare unicellular algal cells for transmission electron microscopy.

RESULTS

Immunocytofluorescent microscopy.

The results obtained by treating fixed D.primolecta cells with the anti-B12 antibody and FITC labelled antiserum are shown in Plate 6.1. Using the initial, optimum incubation concentrations of both antibodies, no fluorescence was visible in cells exposed to a high B12 concentration (Plates 6.1 A and B) or with control cells grown without B12. Increasing the concentration of both antibodies resulted in the fluorescence both of cells exposed to B12 and the controls. This is shown in micrographs C and D of Plate 6.1 for cells containing B12, and for controls in micrographs E and F. This indicated fluorescence due to non-specific antibody binding.

It was possible that the lack of fluorescence in the initial treatment was due to an inability of the B12 antiserum to bind the vitamin within the cell after fixation. Therefore the second antiserum treatment, exposing living cells to the B12 / antibody complex, was tried. However, as in the case of the initial treatment, no fluorescence could be detected.



Plate 6.1 Micrographs of D.primolecta cells  
observed under transmitted visible and incident  
U-V illumination after treatment with rabbit anti-  
B12 and FITC labelled anti-rabbit sera. x 1165.  
A and B - Cells grown with B12 and incubated with  
the initial, optimum antibody concentrations.  
C and D - Cells grown with B12 and incubated with  
10 x the initial antibody concentrations.  
E and F - Control cells grown without B12 and  
incubated with 10 x the initial antibody  
concentrations.

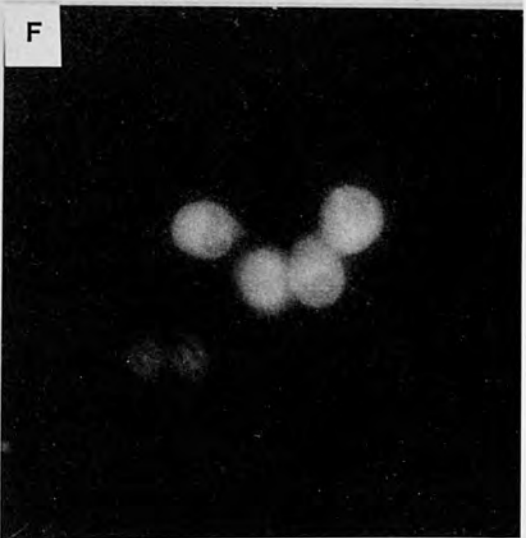
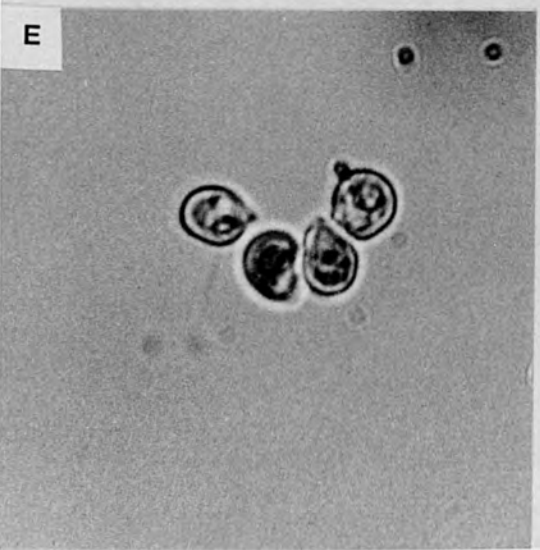
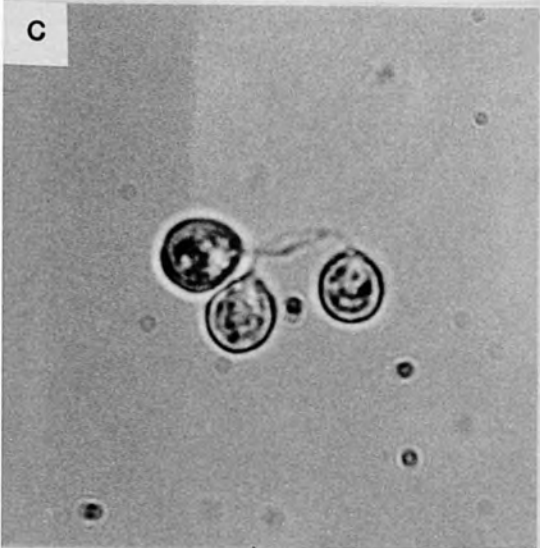
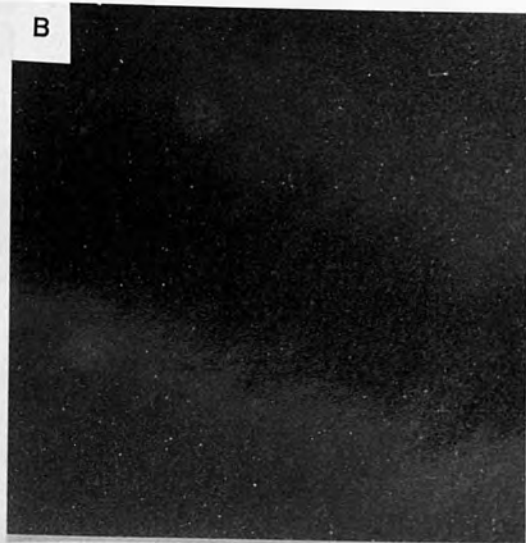
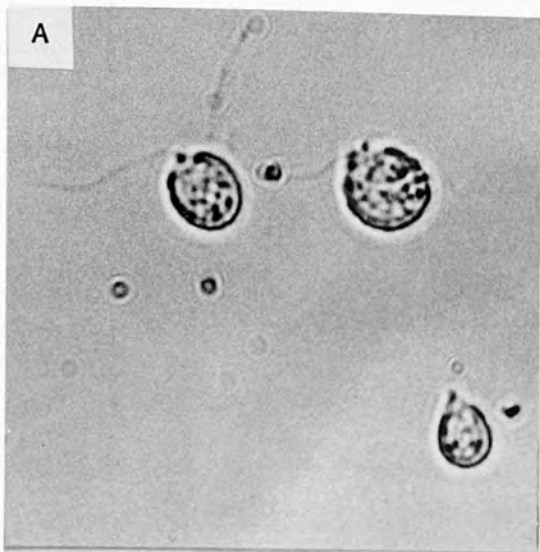

Electron probe micro analysis.

Plate 6.2 shows a whole cell of D.primolecta as prepared for transmission electron microscopy by the complete schedule given in Table 6.1. Good preservation of all cellular detail is shown, and complete sections were readily obtainable.

For EPMA, it was thought desirable to have maximum sensitivity in order to detect the small amounts of cobalt thought to be present. Although the principal X-ray emission lines of cobalt (6.93 KeV) and osmium (8.91 KeV) are quite distinct, it was thought possible that the X-ray emissions from large quantities of osmium or any other heavy metals, such as the counterstains, might mask the small X-ray emission peak of cobalt. Therefore, cells were also prepared omitting osmium tetroxide treatment. However, this produced cells with areas devoid of cellular structure and incomplete resin impregnation, resulting in sections showing large holes when subjected to the electron beam. This is shown in Plate 6.3, and is thought to be due to poor fixation of the lipid components of the cell, resulting in material being lost from the preparation. The standard preparation schedule including osmium was therefore used.

Preliminary examinations of D.primolecta sections by Zeiss U.K. using the energy dispersive analysis

Plate 6.2 Electron micrograph of a whole cell of Dunaliella primolecta in L.S x 26 700, showing the nucleus (N), large cup-shaped chloroplast (C) containing the pyrenoid (P), mitochondria (M) and vacuoles (V). A section of one of the two flagella (F) is visible outside the cell. Also labelled are the plasma membrane (PM) and chloroplast envelope (CE).



Plate 6.3 Electron micrograph of D.primolecta cells prepared for TEM without osmium treatment, showing the loss of regions of cellular structure and holes in the section. Also noticeable is the poor fixation of membranes. x 20 250.

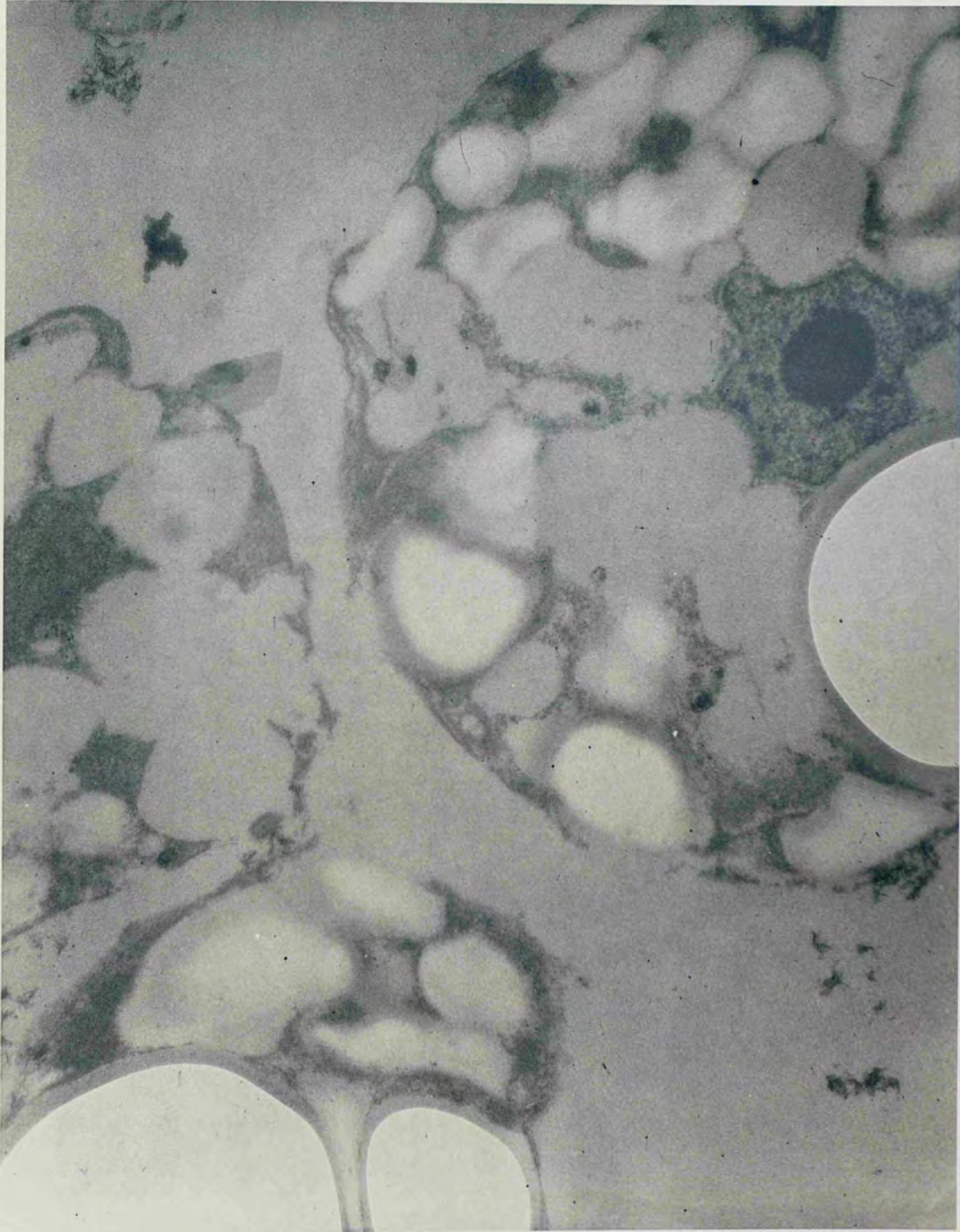



technique could not detect the presence of cobalt. It was concluded that the vitamin was insufficiently concentrated at particular binding sites in the cell to allow localisation by this method, and it was not pursued further.

### DISCUSSION

It was recognised that the localisation of cellular B12 binding sites would be hindered by the small amount of vitamin taken up. The high degree of sensitivity and specificity conferred by the immunochemical method were therefore considered to recommend this as a promising technique for the investigation.

It may well be that the failure of this technique was due to an inability of the anti-B12 serum to recognise and bind to the vitamin when bound to receptor proteins, almost certainly because the antigenic site became concealed on binding to the receptor. Similarly, when complexed with its antibody the vitamin may have been unable to bind to the receptor site. It is, of course, possible that there was insufficient B12 present in the cells to allow the detection of fluorescence resulting from specific antibody binding.



Electron probe micro analysis would have overcome the problems of the indirect immunochemical method by detecting the B12 molecule itself. Using this technique, specific sites within the cell could be investigated, and as little as 0.1% by weight of an element could be detected (Goldstein, Newbury, Echlin, Joy, Fiori and Lifshin 1981), allowing extremely small quantities to be localised. The maximum overall B12 cobalt concentration found in algal cells is actually between  $10^4$  and  $10^5$  times less than the above figure. However, if the vitamin was concentrated in specific binding sites, as might be expected, localisation would still have been possible using this technique. However, it was concluded that B12 was present in insufficient quantities to be detected by EPMA of the cobalt.

It had been hoped to pursue an extremely sensitive and specific localisation by a combined immunochemical, TEM and EPMA investigation. This would have required the production of an antibody to the purified B12 binding proteins, which would recognise the in vivo receptor sites. A colloidal gold labelled antibody could then be used to bind onto the antibody to the receptor, allowing direct visualisation of the complexed site in the TEM. This could then be confirmed by EPMA of the gold label. Unfortunately, it was not possible to purify sufficient quantities of the binding proteins to allow an antiserum to be raised.

It is therefore considered unlikely that it is possible to readily locate the cellular B12 binding sites in algae.

CHAPTER 7 - A COMPARISON OF B12 BINDING BY  
ALGAL CELLS AND CHLOROPLASTS.

INTRODUCTION

Although it was not found to be possible to locate the in vivo site(s) of cellular B12 binding, previous studies have been done on the sub-cellular distribution of labelled cobalamins, which have produced conflicting results.

In studies on vitamin B12 binding and utilization by unicellular algae, the flagellate Euglena gracilis has been most commonly employed. Working on this organism, Sarhan et al. (1980) found that over 60% of vitamin B12 taken up by the cell was localised in the chloroplast, and went on to demonstrate similar binding properties for chloroplasts and intact cells. This led them to suggest that chloroplasts might represent the major intracellular binding site for B12, and regulate uptake by the whole cell.

However, earlier studies by Varma et al. (1961) had found no bound B12 associated with the chloroplast in this organism. Also working on E.gracilis, Isegawa et al. (1984) showed that chloroplasts accounted for only 21% of intracellular B12 binding.

To elucidate the question of vitamin B12 binding

by the chloroplast and its possible significance, the characteristics of B12 binding by intact chloroplasts and whole cells of Dunaliella primolecta, which has a single prominent chloroplast, were investigated.

#### MATERIALS AND METHODS

##### Preparation of chloroplasts.

Isolated, intact chloroplasts were prepared by the procedure of Kombrink and Wober (1980), by adding DEAE-dextran dissolved in Hepes/NaOH buffer pH 7.4 to a suspension of cells in buffer on ice to give a final concentration of 1mg DEAE-dextran per mg chlorophyll. Chlorophyll content of cells was estimated by the method of Inskeep and Bloom (1985). After cell lysis at 30°C for 5 minutes, chloroplasts were collected by centrifugation at 500g, and gently resuspended in fresh buffer. This differential centrifugation served to remove cell debris and other organelles from the preparation.

The exact mechanism of lysis is unclear, but it is known that polycationic molecules such as DEAE-dextran are titrated with counterions at the membrane surface. This leads to firm binding which, unless an excess of polybase is used, prevents contact with and lysis of

the chloroplast envelope.

Cell and chloroplast numbers were enumerated by absorbance 675 nm measurements and haemocytometric counts (See Chapter 2). Cells and chloroplasts were observed under transmitted and phase contrast illumination on an Olympus BH-2 microscope, and photographed on Ilford FP4 film, downrated to ASA 64.

Determination of B12 binding.

Cells and chloroplasts were pre-incubated in buffer for 45 minutes, after which time  $^{57}\text{Co}$  B12 was added at the appropriate concentration. After the determined time interval, 0.5 ml of the incubation mixture was withdrawn and filtered through a Whatman GF/A glass microfibre filter in an MPS unit (see Chapter 2) under 500g centrifugation for 1 minute. The filter was then immediately washed under similar conditions with 1 ml buffer to remove non-specifically bound vitamin, and air dried before counting in an L.K.B mini-gamma counter.

For the investigation of concentration dependence of binding, an incubation period of 1 hour and  $^{57}\text{Co}$  B12 concentrations of 41.3 to 495 ng  $l^{-1}$  were employed. Cells and chloroplasts from cultures in logarithmic phase were diluted to a density of  $2.05 \times 10^5$   $ml^{-1}$ . In time dependence studies, cells and chloroplasts were

similarly harvested and used at  $4.24 \times 10^5 \text{ ml}^{-1}$  and  $1.94 \times 10^5 \text{ ml}^{-1}$  for initial and secondary phase studies respectively. (A greater density was used for initial phase studies, so that sufficient vitamin would bind for accurate radioactive counting). In long term, secondary uptake experiments, radioactive B12 was added at  $760 \text{ ng l}^{-1}$ , and incubation times ranged from 2 minutes to 7.5 hours.

For the determination of initial phase B12 binding for periods up to 1 minute, a derivation of the rapid dilution method of Bradbeer (1971) was developed. After addition and rapid mixing of  $^{57}\text{Co}$  B12 at  $415 \text{ ng l}^{-1}$ , an aliquot of buffer, equal to the total volume of the incubation mixture containing unlabelled B12 at 200 times the concentration of the radionuclide, was added to effectively halt further  $^{57}\text{Co}$  B12 uptake. 1 ml of this mixture was immediately filtered, washed and counted as above.

Extracellular B12 binding capacity of the cell incubation mixture was determined by the ultrafiltration technique described in Chapter 2.

## RESULTS

### Preparation of chloroplasts.

Microscopic examination under phase contrast illumination conditions showed that intact cells and chloroplasts were readily distinguishable (see Plate 7.1, A and B). Chloroplasts lacked the discrete, dark limiting envelope representing the cell membrane, and often appeared slightly swollen and somewhat irregular. However, they still showed fluorescence indicating the presence of the chloroplast envelope, in contrast to ruptured chloroplasts which were distinctly dark (Plate 7.1 C). Such intact organelles are known to retain their functional integrity (Durr, Boller and Wiemken 1975). Kombrink and Wober (1980) showed that chloroplasts prepared in this way retain ribulose bisphosphate carboxylase activity as well as chlorophyll, confirming plastid integrity. However, pyruvate kinase activity is lost, demonstrating the absence of the cytoplasm, and therefore of intact cells.

The average chlorophyll content of D.primolecta was found to be 4.13  $\mu\text{g} / 10^6$  cells. Using the optimum concentration of DEAE-dextran for lysis, namely 1 mg / mg chlorophyll, 77% intact chloroplasts were obtained with 4% whole cells and 19% ruptured chloroplasts. Lowering the polybase concentration in an attempt to

Plate 7.1 a Intact cells of D.primolecta under phase contrast illumination showing fluorescence and the presence of the dark cell membrane, x 1695.

Plate 7.1 b Chloroplasts isolated from D.primolecta by DEAE-dextran lysis, observed under phase contrast illumination showing an intact envelope indicated by fluorescence, x 1695.

Plate 7.1 c Isolated intact and ruptured chloroplasts from D.primolecta under phase contrast illumination showing the effect of excess DEAE-dextran on chloroplasts, resulting in the loss of the envelope and a swollen and darkened organelle, x 1695.



A

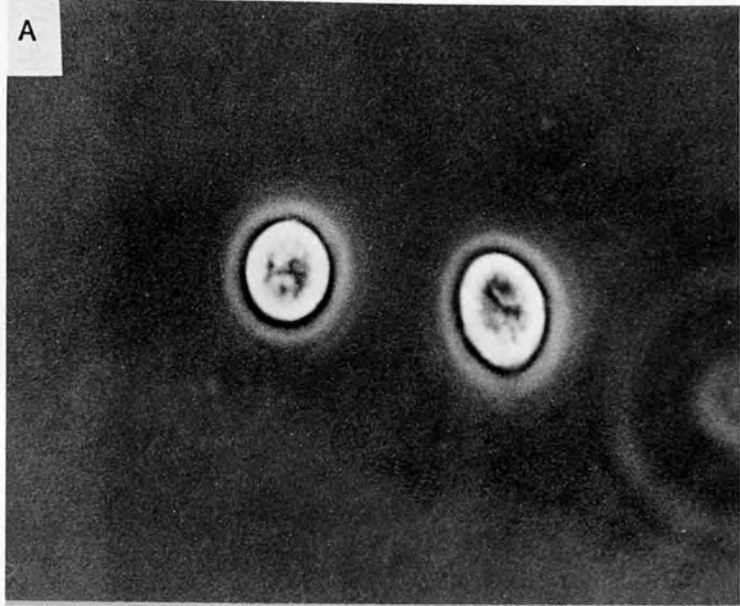

B

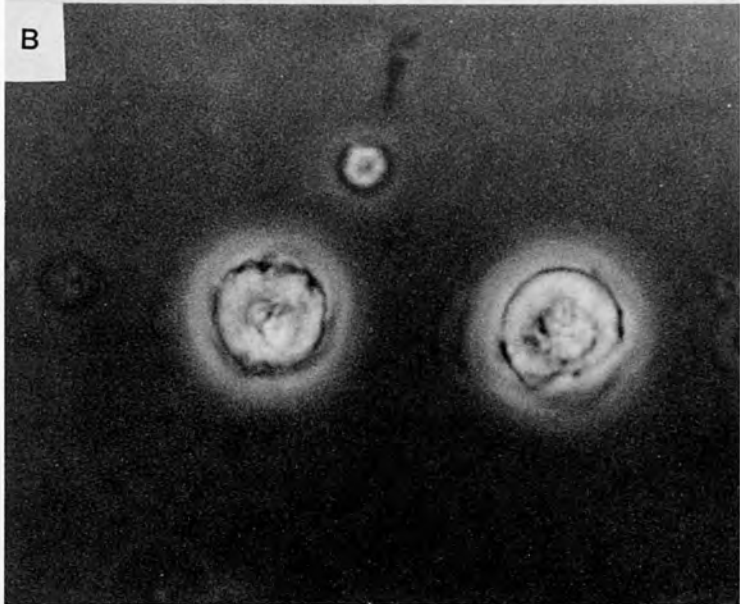

C

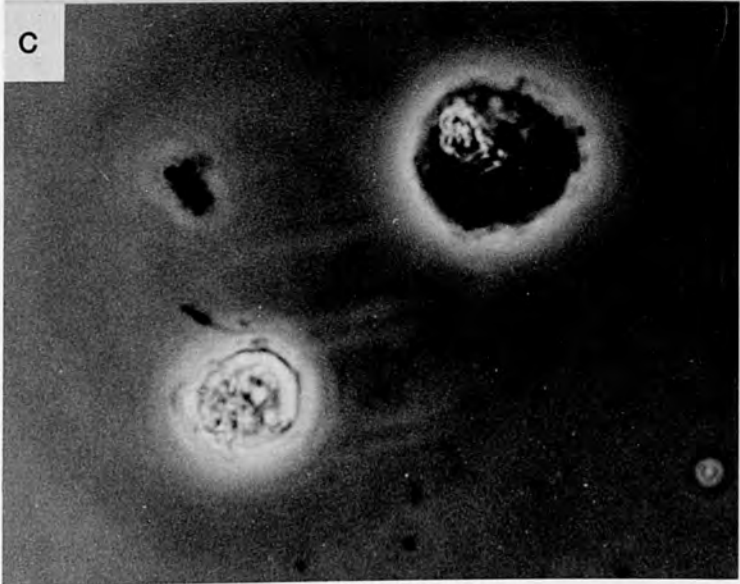

reduce the number of ruptured chloroplasts resulted in 12% unlysed cells but no change in the number of ruptured plastids. This chloroplast rupture is therefore thought to be due to localised high concentrations of the polybase during incubation, resulting in the sequential lysis of both cell and chloroplast membranes as predicted by the results of Kombrink and Wober (1980).

#### Determination of B12 binding characteristics.

An initial investigation showed that chloroplast preparations bound 83% of the B12 bound by cells under similar conditions. Binding due to extracellular products in the medium represented 90% of the cell total. Following this, more detailed studies were therefore conducted.

The results of concentration dependent kinetic binding studies are shown in Figures 7.1 and 7.2 for cells and chloroplasts respectively, which demonstrate similar substrate saturable binding properties. Computer analysis of the data by the method of Eisenthal and Cornish-Bowden (1974) gave values for the dissociation constant,  $K_d$ , of 334 ng l<sup>-1</sup> for cells, and 379 ng l<sup>-1</sup> for chloroplasts. However, as subsequently extracellular B12 binding was detected, despite the use of washed preparations, these values are not

considered completely reliable. Despite this, a marked similarity between cells and chloroplasts is demonstrated.

The initial phase of B12 binding by cells and chloroplasts is represented in Figures 7.3 and 7.4 respectively. Both show the typical response, demonstrated for whole cells of other organisms, of rapid binding with the rate decreasing considerably within 1 minute.

During long-term incubations to investigate the secondary phase of uptake however, unexpected responses were found for both cells and chloroplasts. Apart from an increase between 10 and 20 minutes, a continuous decrease in the amount of bound B12 was shown. Figures 7.5 and 7.6 show the results for cells and chloroplasts.

Microscopic examination revealed that there was no cell lysis during the course of the incubation which could cause the observed decrease. A preliminary study was therefore conducted to determine whether the decrease in cell and chloroplast bound B12 was due to its release in free or protein bound form, by following the time course of B12 partition between cells, extracellular protein and the medium.

It was found that free B12 in the medium gradually decreased, while bound extracellular B12 increased markedly (see Figure 7.7). It should be noted that this

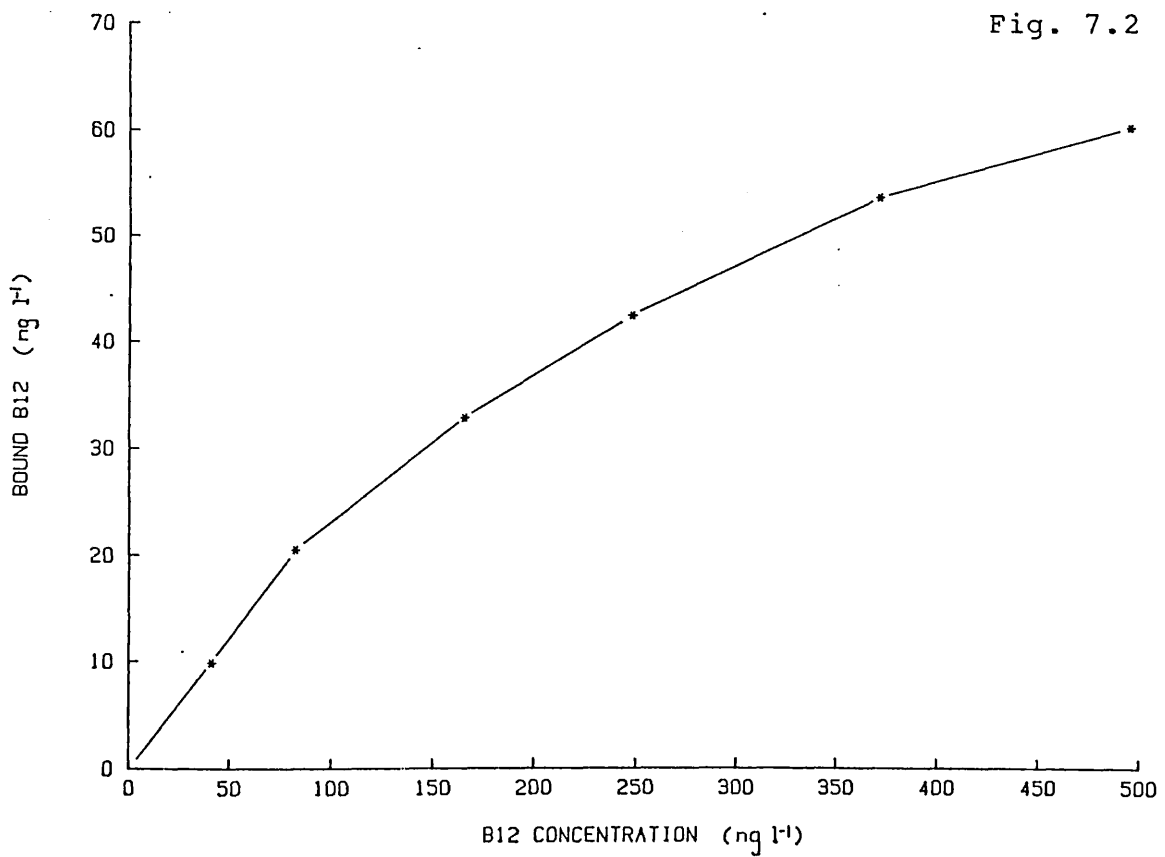
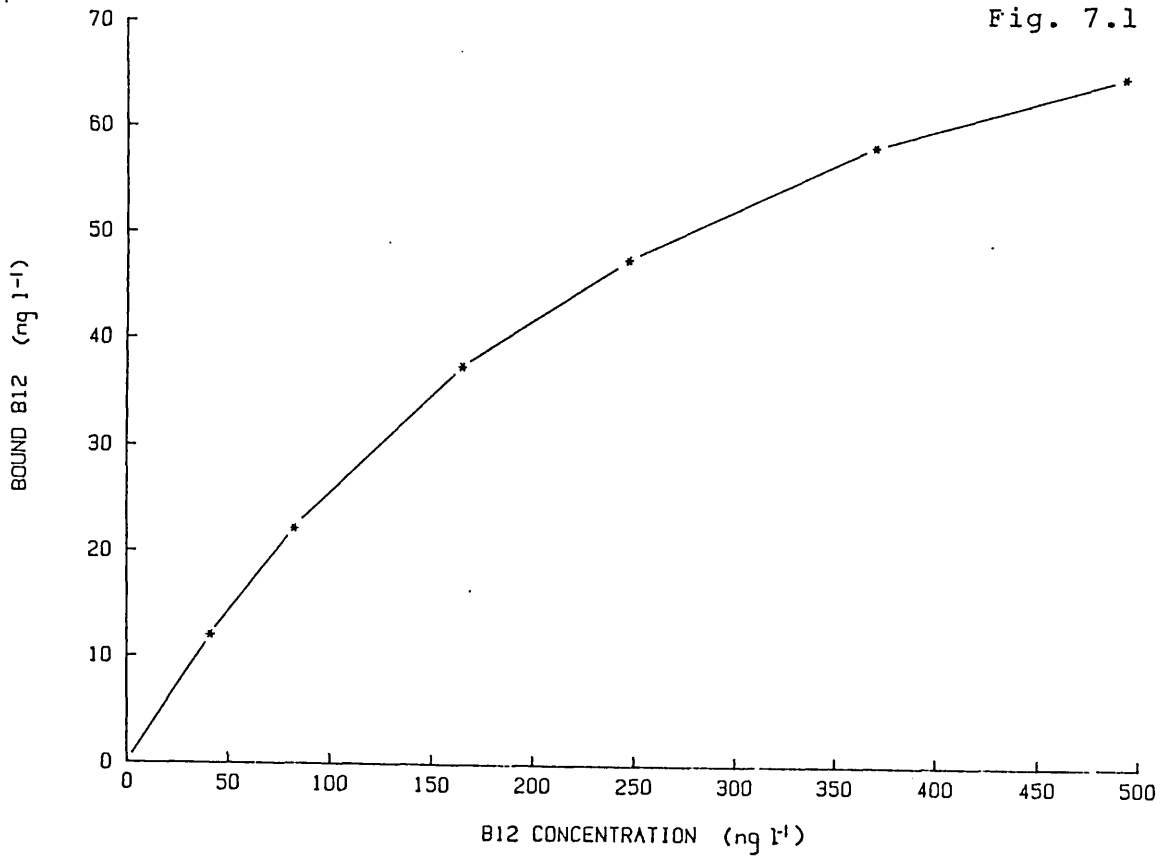

Figures 7.1 and 7.2 The amount of B12 bound by cells (Fig. 7.1) and chloroplasts (Fig. 7.2) of D. primolecta when incubated with different concentrations of B12 for 1 hour.

Fig. 7.3

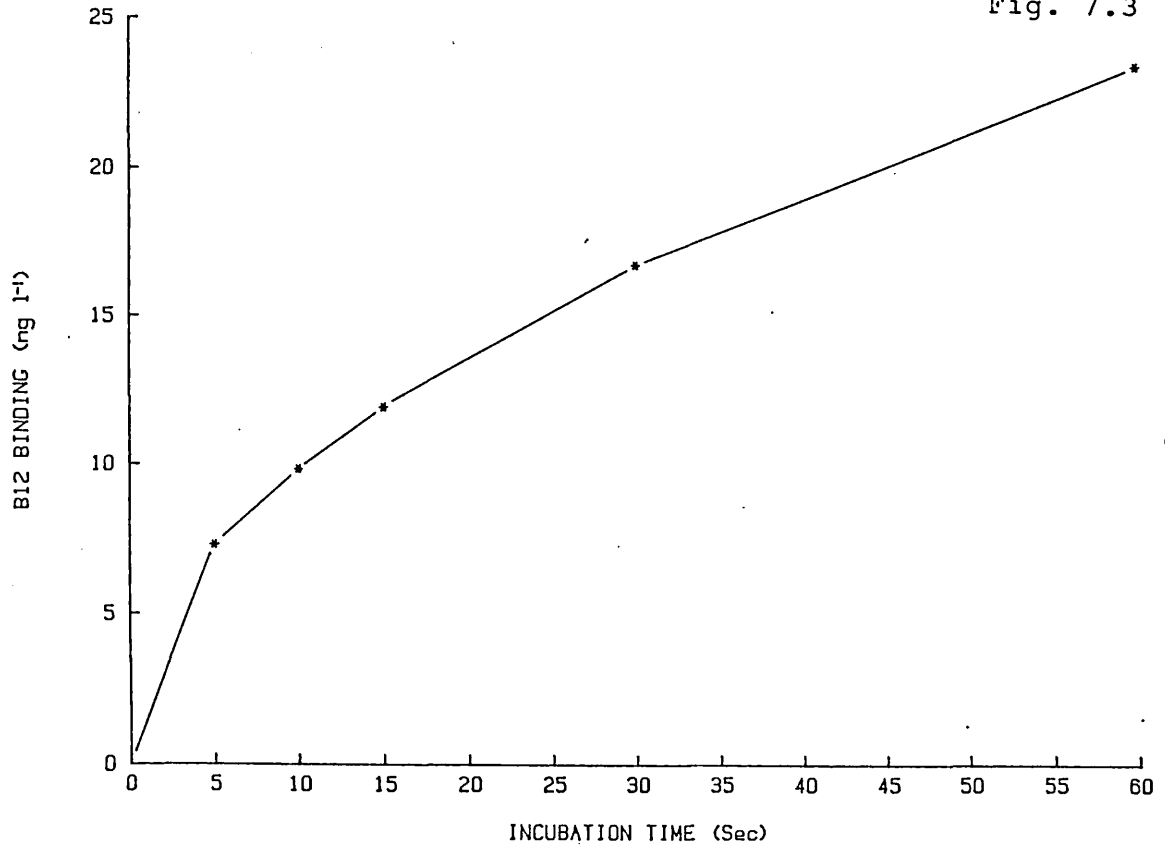
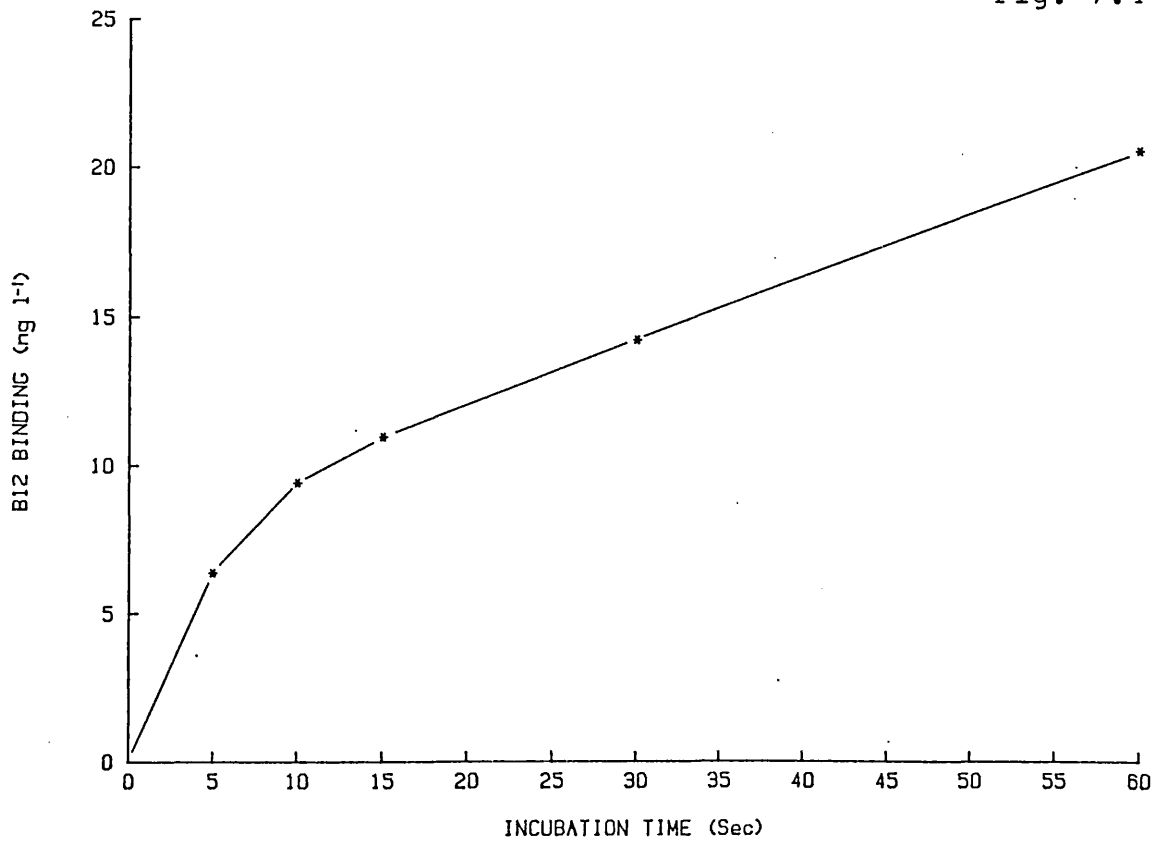

Fig. 7.4



Figures 7.3 and 7.4 B12 binding by cells (Fig. 7.3) and chloroplasts (Fig. 7.4) of D.primolecta during the first minute of incubation with the vitamin.

Fig. 7.5

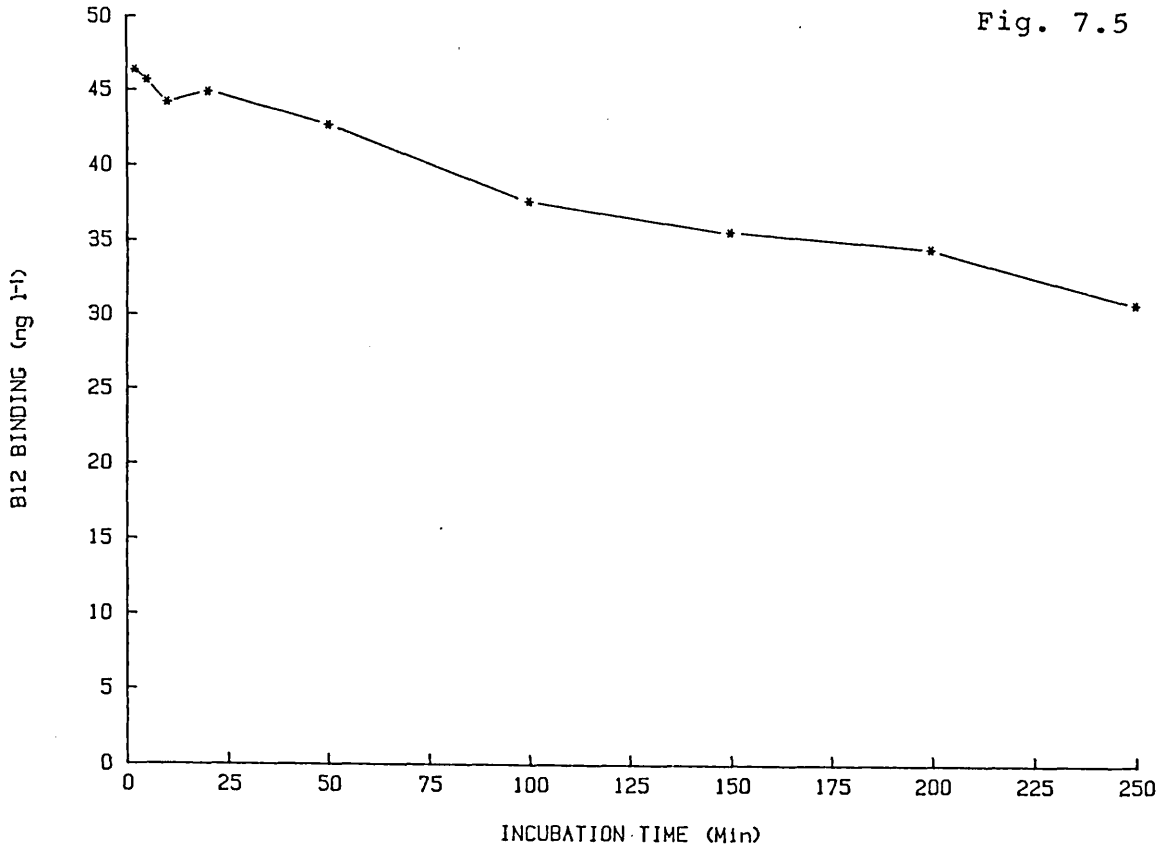
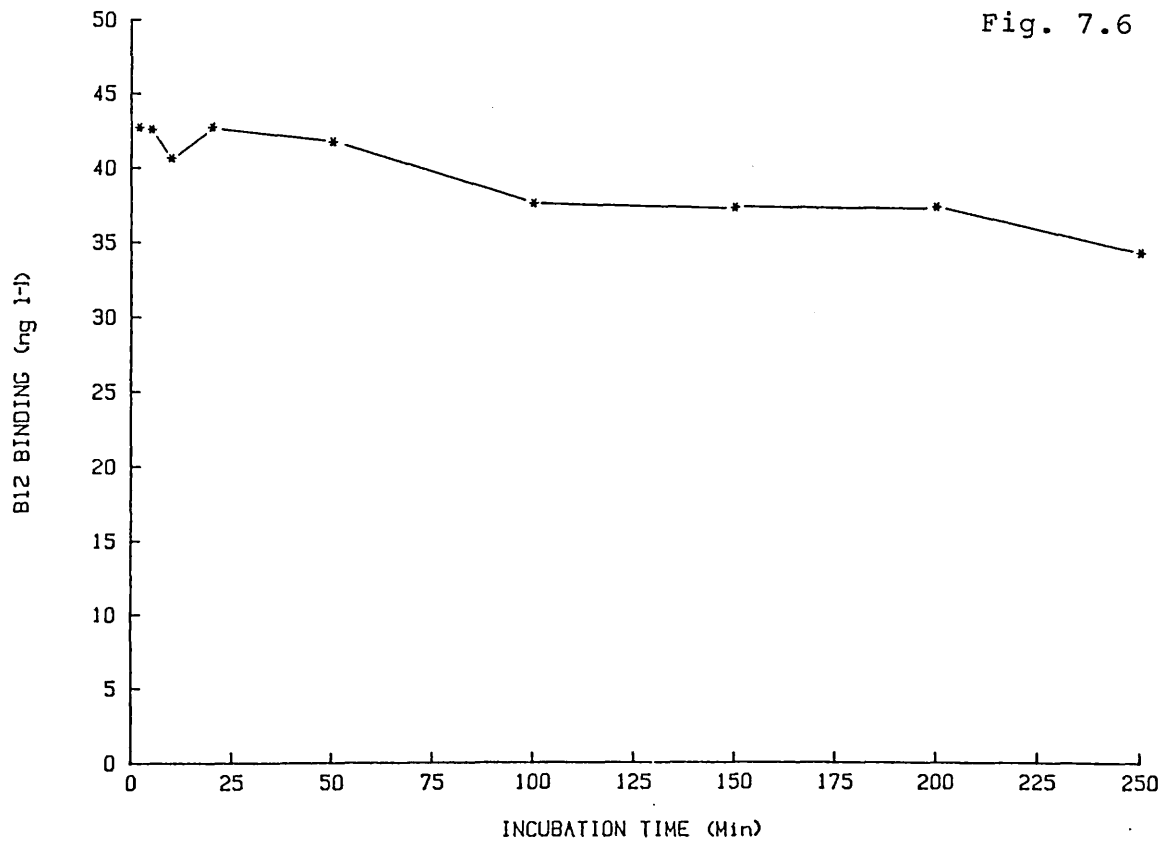

Fig. 7.6



Figures 7.5 and 7.6 The course of B12 binding by cells (Fig. 7.5) and chloroplasts (Fig. 7.6) of D.primolecta over a four hour incubation period.

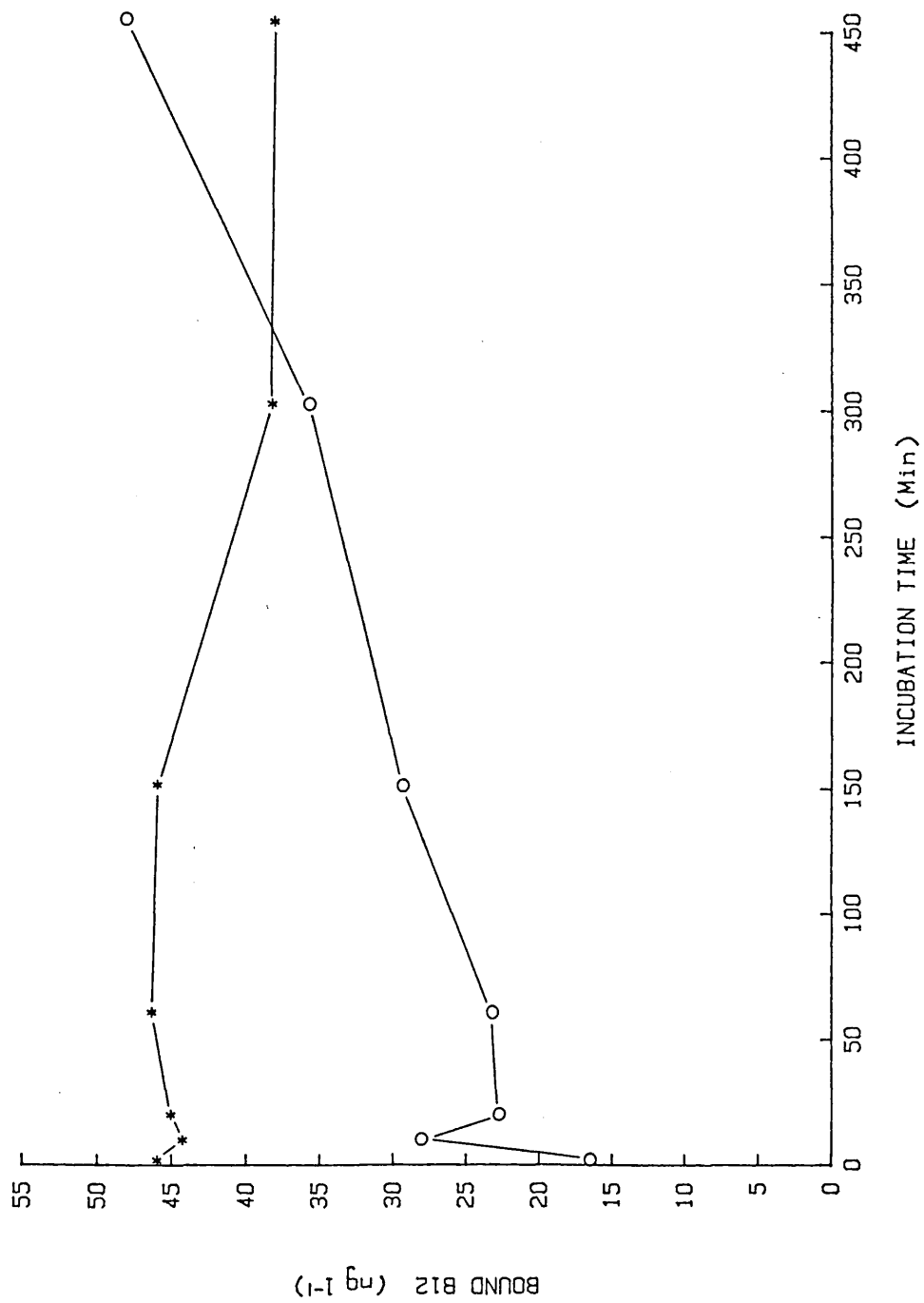

Figure 7.7 The course of cellular ( \* ) and extracellular ( O ) B12 binding by D. primiolecta over a 7.5 hour incubation period.

increase is several times the decrease in cell bound B12. Therefore the total B12 bound increases throughout the incubation period. Also, it would appear that not only is protein bound B12 in the membrane released, but also that uncomplexed binding proteins from the cell are released into the medium where they bind B12.

An additional sampling after 24 hours incubation revealed only a further 13.8% decrease in cell bound B12, and a 7.4% increase in extracellular binding, suggesting that B12 losses to the medium reach a plateau.

#### DISCUSSION

The B12 binding demonstrated for chloroplasts, as well as cells, clearly supports the observed binding associated with chloroplasts of E.gracilis by Sarhan et al. (1980), which conflicted with the earlier report of Varma et al. (1961). The greater magnitude of chloroplast binding in D.primolecta is attributable to the larger size of this organelle in relation to the cell.

The similar concentration dependent, initial and secondary B12 binding characteristics of chloroplasts and cells indicate that the same mechanism is operating in both. This in turn suggests a common origin for the



two systems. Such a discovery is not surprising as the theory of endoserial symbiosis suggests that the outer membrane of the chloroplast is homologous with the plasma membrane, being derived from it by the formation of a phagocytic vacuole upon the original engulfment of a photosynthetic symbiont.

It was proposed by Sarhan et al. (1980) that, as the B12 binding characteristics of E.gracilis cells and organelles were similar, binding to chloroplast sites was responsible for regulating the cell uptake process, perhaps by binding intracellular B12 and maintaining the necessary concentration gradient. They also suggested that the binding of B12 by plastids could have an ecological significance by acting as a cell storage reservoir, and might indicate a role for the vitamin in chloroplast physiology. However, despite other detailed studies, no definite involvement of B12 in chloroplast function has yet been shown.

The current findings enable a simple, comprehensive explanation to be proposed for all observations. Chloroplast B12 binding could be purely a functional relic of the process operating in the cell membrane. Thus the similarity in their binding characteristics simply reflects the sharing of the same fundamental mechanism due to a common origin. A regulatory or functional role associated with the chloroplast is not therefore implied. However, the

latter in particular is not necessarily precluded, and the organelle may have retained its capacity to acquire B12 to fulfil its requirements for the vitamin.

The somewhat surprising discovery that protein-bound B12 in the cell and chloroplast membranes of D.primolecta is freely released promotes interesting hypotheses. Primarily, it may now be suggested that liberation of the binders in chloroplast and cell membranes represents the source of the intracellular and extracellular B12 binding proteins respectively.

Since these binders are so readily released from the cell, this could indicate that they form a component of the outer cell coat. This is known to possess a large glycoprotein component and is somewhat amorphous, leading to the dispersal of cell coat material (Oliveira, Bisalputra and Antia 1980).

One can also speculate that, as there is no direct evidence for a secondary uptake phase, B12 is not actively taken up by D.primolecta, and that initial cell B12 binding represents the relic of an original transport process, similar to the situation proposed for the chloroplast. However, an active secondary uptake phase, which is thought to involve energy dependent transport across the membrane, is definitely not excluded by these observations. Indeed, after 24 hours the majority of B12 bound by the cell is still associated with it, suggesting long-term or

intracellular binding. Additionally, total B12 binding follows a pattern similar to that observed for cells with biphasic uptake.

It is possible that the incubation conditions caused an inhibition of, or decrease in, the secondary phase, or even promoted the release of membrane-bound B12. However, as Varma et al. (1961) showed that uptake is virtually unaffected by the composition of the medium, this is not considered particularly likely.

There is a dramatic increase in extracellular bound B12 in the first ten minutes, although it might be expected that a large amount of B12 would be immediately bound by proteins released into the medium during the 45 minute pre-incubation period, and that any increase in extracellular binding would be gradual. Additionally, in these studies there is a noticeable increase in cell-bound B12 between 10 and 20 minutes, concomitant with a fall in the fraction bound in the medium. It would therefore appear that the explanation involving a simple mechanism of B12 binding by proteins in the medium and membrane may not suffice.

One possibility is that a dimerisation process akin to that in the mammalian binding system is operating. In this case individual protein molecules would bind B12, and then form a dimer which could be necessary for B12 transport into the cell. Thus although extracellular proteins can bind B12 and

dimerise with each other, they would also be able to form dimers with membrane proteins, resulting in cell uptake. Initially, membrane proteins in close proximity to one another will form dimers more readily than those in the medium at a lower concentration, but would also contribute substantially to the amount of extracellular bound B12 by release after binding B12 in the membrane. However, extra information is obviously required before theorising further.

Therefore these investigations into B12 binding by D.primolecta have revealed several interesting features of the uptake process in this previously unstudied organism. They also promote advances in a wider understanding of B12 binding by unicellular algae.

Clearly, more detailed studies of this uptake process are warranted, in particular into whether there is a secondary, active transport phase functioning and mediating accumulation within the cell. Whether dimerisation facilitates this, or perhaps another stage in B12 uptake, would also be of considerable interest.

CHAPTER 8 - SUMMARY AND GENERAL DISCUSSION.

It will be apparent that some of the major lines of investigation into vitamin B12 uptake and binding by unicellular algae, in particular the purification and cellular localisation of the binding proteins, are inevitably hindered by the small quantities of B12 utilized, and hence the limited amounts of the binders produced.

However, the multifarious studies conducted in this thesis have produced important new information concerning micro-algal B12 binding and clarified previously uncertain aspects, enabling significant advances to be made in the understanding of the processes involved. These findings may be briefly summarised as follows:

1. Extracellular B12 binding protein is released by both autotrophs and auxotrophs at the same rate as total extracellular protein. The amount present in the medium is directly proportional to cell density.

2. Extracellular binding proteins are stable in artificial seawater medium at 4°C and also room temperature for at least 1 month, but a proportion of B12 binding activity is lost in the presence of cells or in the light.

3. During the early and exponential phases of growth, the majority of available B12 in the medium is bound by cells. The ratio of EBP to cell binding increases as growth continues towards stationary phase.

4. A B12 binding protein has been definitively identified in both the intracellular cytosolic and membrane-bound phases of algal unicells, as well as in the extracellular medium. Binding by proteins isolated from the membranes accounts for between 42 and 57 % of the total B12 capacity of cultures, with cytosolic and extracellular binding representing 11 - 31 and 26 - 43 % respectively, these proportions being noticeably variable.

5. Although limited by difficulties found to be associated with their purification, proteins from the three fractions have been characterised. These binders appear to be either closely related or identical, demonstrating a similar composition and high molecular weight. In addition, the binding proteins of different species show marked common characteristics.

6. These proteins are produced in relatively small quantities, but are capable of binding B12 well in excess of the cell's minimum requirement. As well as a high affinity for B12, the binders demonstrated non-specific, unusual binding properties.

7. Chloroplasts have been shown to represent a major intracellular binding site for B12. This

organelle shows similar uptake properties to whole cells in D.primolecta. However, this uptake process demonstrates unusual features, in particular a loss of cell bound vitamin to an extracellular bound form.

8. No apparent differences between B12 binding by autotrophs and auxotrophs have been found in these studies.

It may be seen from the review of algal B12 uptake and binding in the general introduction (Chapter 1.4.3) that, although a number of general studies have been done on this subject, there is a lack of detailed information. In addition, there are some apparently conflicting reports which present a complicated picture, and thus it has been difficult to draw straightforward and comprehensive conclusions.

Of particular interest are the following three areas which were not well understood: the mechanism of cellular vitamin B12 uptake, what binding occurs within the cell and the origin and function of extracellular B12 binding proteins. The findings reported here and the results of previous work now enable explanations and theories to be presented covering each of these areas.

The enigmatic, and so far unexplained, release of extracellular B12 binding proteins is one of the most interesting features of micro-algal vitamin B12

binding. The high affinity and specificity of these binders for the vitamin is considered to preclude the possibility of another function and B12 binding being merely incidental. Three theories may be advanced to account for this phenomenon.

Firstly, these binders may function as ectocrines specifically produced to retard the growth of other organisms by sequestering available vitamin B12. Clearly such a strategy would only be effective against B12 requirers which, in the aquatic environment, would principally be auxotrophic algae. The effectiveness of this however is enhanced by the fact that, until exponential growth is declining, the majority of available vitamin is bound by cells, and also that extracellular binding protein probably remains active in the environment for the duration of that season. Hence the producing organism can take up all its B12 requirements, even for a substantial bloom, unaffected by its own extracellular binder, although immediately following and subsequent species will be inhibited.

Messina and Baker (1982) showed that EBP could indeed act as an ectocrine in this way in laboratory cultures. Differences in test growth responses to samples from different water bodies could also suggest that extracellular B12 binding can play a role in species succession. However, cell densities and



conditions in culture are rarely, if ever, found in the natural environment. Therefore, it is difficult to extrapolate these findings (Hellebust 1974).

Although it is clearly possible for EBP to function as an ectocrine, whether it does in practice, and if it is specifically released for this purpose, cannot be defined with certainty on this information alone.

A second possibility is that release is non-specific and represents a loss of the binding protein from the cell. Thus no particular role is performed. The excretion of a wide range of substances including polypeptides and proteins is quite common among algae (Hellebust 1974). Release of simple compounds is usually by diffusion through the plasma membrane, in which case the extracellular level depends on internal concentration, while larger compounds can be specifically released by exocytosis involving the fusion of vesicles with the membrane. Material is also liberated during reproductive processes and due to autolysis, especially in the stationary phase of old cultures.

Normally the release of high molecular weight products is limited, and proportional to the amount of growth (Fogg 1975). These facts would support the idea that the release of extracellular B12 binders, which are found in small quantities proportional to the cell

density like other extracellular proteins, occurs primarily due to liberation at cell division. Autolysis probably also accounts for the origin of some of the binding protein. No specific function would therefore be implied.

The studies of B12 uptake by D.primolecta revealed that binding proteins are readily released from the cell over short periods. They may therefore be unstable or only loosely associated with the plasma membrane, or a component of the cell coat. This provides an alternative source for non-specific release.

A final potential explanation for extracellular B12 binders could be an involvement in cellular vitamin uptake. This could plausibly be similar to the mammalian uptake system where extracellular proteins bind the vitamin in the surrounding medium, before forming a complex with a similar receptor protein in the plasma membrane, facilitating transport into the cell.

It is clear from several studies (see Chapter 1.4.3) that no extracellular binding is necessary for B12 uptake by algae. Therefore any possible role of EBP in this process would be essentially superfluous, and would probably represent a relic of an earlier, superseded mechanism in which EBP was involved. This idea is not without some supporting evidence, albeit rather tentative. The studies of D.primolecta revealed

an apparent release of binding protein which was then rebound by the cell after complexing with the vitamin. This could be a vestigial dimerisation process akin to that described above.

Clearly, to elucidate this would require further study. However, it would not now appear to be of substantial importance in micro-algae.

One of the most valuable discoveries that has been made is that the extracellular binding proteins are fundamentally similar to the cellular binders, with an apparently common origin. This enables an integrated model to be proposed for the role of EBP. Extracellular binders may originally have been involved in B12 uptake by the cell, but now represent the non-specific release of cellular binding proteins. As a fortuitous by-product, however, these may act to promote or prolong the bloom of the releasing organism by retarding other B12 requirers.

With regard to intracellular binding, the chloroplast has now been clearly shown to be capable of sequestering B12 to a degree comparable with the whole cell. It therefore undoubtedly binds a significant proportion of the vitamin taken up by the cell. However, it is highly probable that other organelles bind B12 as suggested by other work e.g. Reeves and Fay (1966), Isegawa et al. (1984). This would be consistent

with the knowledge that B12 co-enzymes perform a range of functions as discussed in Chapter 1.3.

Binding by cytosolic proteins has also been established, and a proportion of intracellular B12 will be associated with this phase. It is apparent that the amount of cytosolic binding protein is variable, and it is not yet clear if this performs an intracellular transport role, or whether it has any other role in binding the vitamin, perhaps acting as an intermediate store of B12. A further investigation of the production of these binders, and whether they combine with the vitamin only temporarily during transport or act as a reservoir by longer-term binding, would therefore be of interest.

Droop (1968) could not determine whether a diffusion or active transport process for vitamin B12 was occurring in P.lutheri. Similarly, Bunt (1970) was unable to distinguish between facilitated diffusion and active transport of the vitamin in macro-algae.

Several studies have shown that cellular B12 uptake in algae is dependent on factors such as pH and temperature, and is an energy-requiring process. Herold and Sullivan (1980) suggested that uptake of B12 in T.pseudonana was by an active, mediated transport system. However, no model for the B12 uptake mechanism has yet been put forward.

Although algal B12 binding shows certain similarities, such as pH dependence and Michaelis-Menten kinetics, with a permease system involving penetration catalysed by a receptor protein, cyanobalamin has a molecular weight of 1355 and is accumulated against substantial concentration gradients. This, and the requirement for energy to effect transport, precludes a passive or facilitated diffusion process for algal B12 uptake.

This study has shown that there is only a single membrane-bound B12 binding protein, which enables two conclusions to be drawn. Firstly, there is clearly only one type of cell-surface binding site for the vitamin. Secondly, in contrast to bacterial B12 uptake, the algal system appears to be relatively simple, and a broad model can be put forward.

A B12 receptor on the outer surface of the plasma membrane binds cobalamins from the medium. This protein is then responsible for energy dependent transport to the inside of the cell, where it is released into the cytoplasm. This is shown in Figure 8.1, along with other important features of algal B12 binding.

At least two different processes would account for the energy requirement. Energy could be used to translocate the receptor protein in the membrane, moving its active site. Alternatively, energy could be required to produce a conformational change in the

Figure 8.1 A diagrammatic representation of the features operating in vitamin B12 binding and uptake by micro-algae. Cellular uptake occurs in two stages: initial binding to a high affinity receptor (M) in the plasma membrane (PM), followed by energy-dependent internalisation effected by the same protein. Intracellularly, the vitamin can be bound by proteins found in the cytosol (C) and also located in organelle membranes (M'), in particular the chloroplast envelope (CE). In the external medium, B12 is bound by extracellular binders (E). Significantly, the three binding proteins identified show similar characteristics.

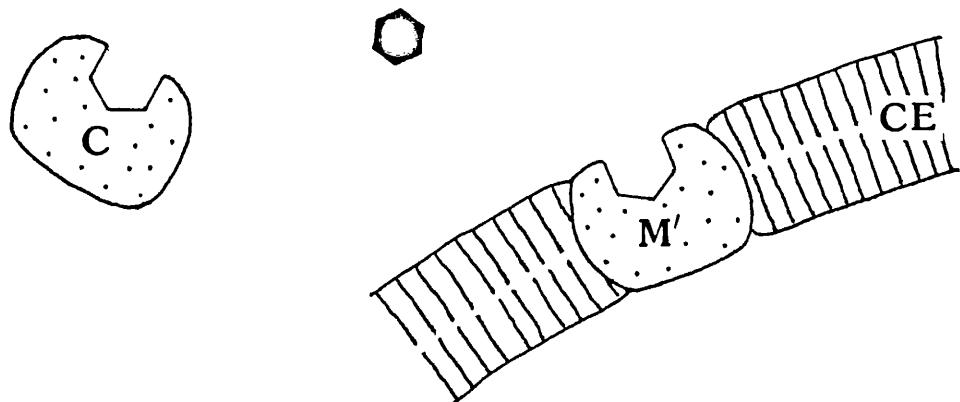
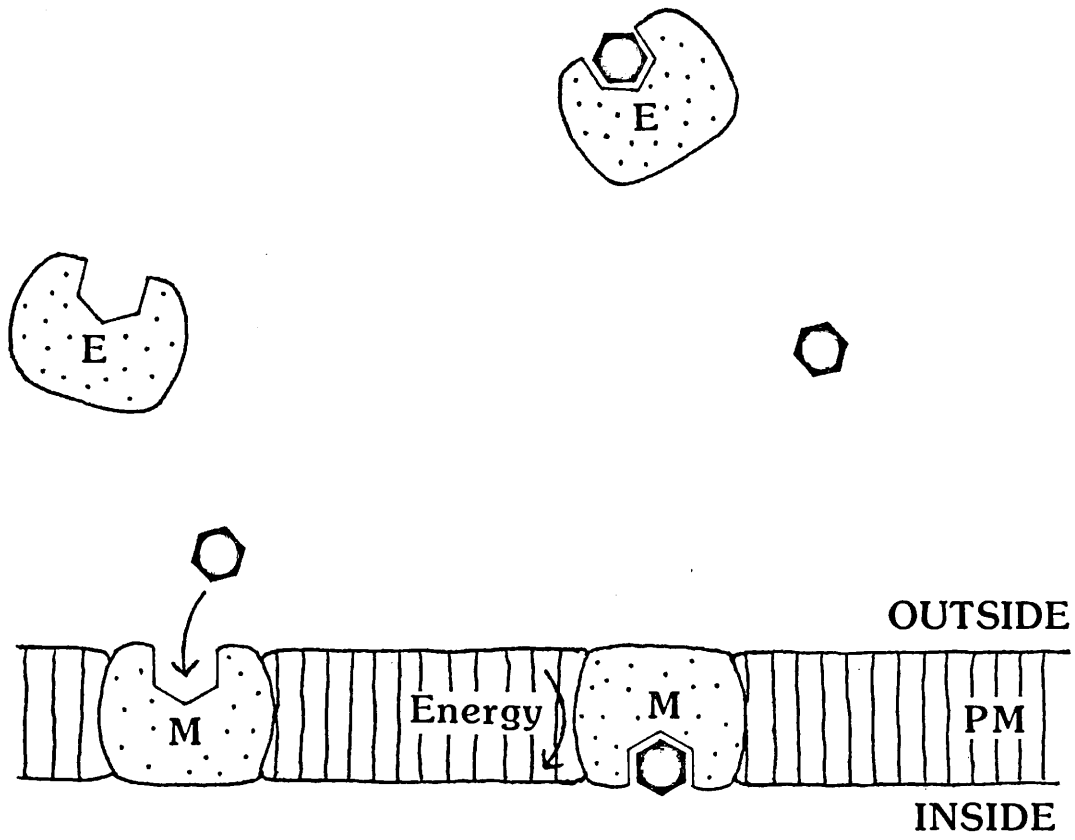

carrier to its high affinity state for the vitamin. In either case, release of B12 from the receptor into the cytoplasm is probably accompanied by a change to a conformation with a low association constant for the vitamin. Since high affinity binding to the extracellular protein, which has been shown to be similar to the cellular binders, does not involve energy, the latter hypothesis can probably be discounted.

A further explanation of an energy requirement is engendered by the observed stimulation of B12 binding and uptake by  $Ca^{2+}$  in the mammalian and bacterial systems and also in O.malhamensis (See Chapter 1.4). This possible involvement of  $Ca^{2+}$  might well be represented by its co-transport with vitamin B12. Such cationic involvement is thought to occur in other uptake systems. The cell receptor protein could possess a site for the calcium ion which, when bound, increased the affinity of the receptor for cobalamins. The ion would be transported across the membrane with the B12 molecule, and its liberation in the cytosol promote the release of the vitamin from the receptor due to an affinity change. It would then be necessary to extrude calcium back across the membrane by an energy-driven pump mechanism.

An alternative, cohesive mechanism covering algal B12 uptake can be proposed. All the features discovered



regarding uptake of the vitamin, namely a two-stage energy requiring process dependent on temperature and pH, sensitive to metabolic inhibitors and involving a high-affinity receptor, are characteristic of receptor mediated endocytosis (Dautry-Varsat and Lodish 1984).

In this process, the molecule taken up binds to a protein on the surface of the cell membrane, which is capable of sequestration even at low concentrations. This triggers an invagination of the membrane to form an enclosed vesicle which brings about internalization. It is this stage which requires energy. The transferred molecule dissociates from its receptor within the vesicle once in the cytoplasm. This leads to its intracellular release, while the protein is recycled to the cell surface where further binding can take place. Clearly this represents a highly plausible explanation of algal B12 uptake.

Whatever the precise mechanism though, the basic features of the general model described above apply, and only one specific protein is involved. Further study of the process, perhaps using a heavy metal labelled vitamin to visualise uptake or more detailed metabolic investigations, could yield a more complete interpretation.

The practical implications of algal B12 binding under natural conditions deserves final consideration.

In the aquatic environment, nutrient cycles are complex and the effect of mixing is important. Additionally, although nitrogen is most often the primary limiting factor for phytoplankton, a single limiting nutrient model is almost certainly an over-simplification (Burton 1980). In view of these findings, making reliable assessments of this topic is difficult. However, as discussed in Chapter 1.6, B12 can almost certainly affect species succession and quite possibly even total productivity under certain conditions.

The synthesis of cobalamins is a complex and multi-stage process (Battersby 1986). It has been found that negligible labelled cobalt, the essential core element for B12, is incorporated into algae when present in the environment (Daisley 1969). Hence, while uptake of the vitamin is obviously essential for auxotrophs, it is also an energy-conserving process for autotrophs.

Clearly, an ability to accumulate effectively available B12 capable of meeting the maximum requirements of the organism and also to deprive competing species of the vitamin, either by the cell sequestering it or by extracellular binding, is advantageous. Hence the rapid cellular uptake and also binding by EBP are mechanisms which obviously favour initially-developing algae at the expense of subsequent species.

Therefore, the features that have been identified in algal B12 binding are of considerable potential significance, and would warrant further study and evaluation.



ACKNOWLEDGEMENTS.

I should like to express my sincere thanks to Dr T.W.Ford for his very dedicated supervision, advice and encouragement, and also to Dr J.W.Leftley for his advice and role in developing this project.

The expert help of Dr M.McDonough with amino acid analysis, Grahame Lawes and Kevin Jennings with electron microscopy, and Lynne Etherington and David Ward with photographic services is very gratefully recorded. I should also like to record my appreciation of the encouragement and assistance of many members of the Botany Department at Huntersdale.

I gratefully acknowledge the synthesis of APC by Prof. Golding and Ruth Dixon of the Chemistry Department, Newcastle University, and the permission of Drs. Davies and Leftley to include the data in Figures 3.3-5 which was obtained during experiments conducted under their auspices at the SMBA.

Finally, I wish to express my deep appreciation of all those special friends and family who have cared and helped in so many ways during the past three years.

This project was kindly supported by a Natural Environment Research Council CASE studentship award.

REFERENCES.

Allen, R.H. and Mehlman, C.S. 1973. Isolation of gastric vitamin B12 binding proteins using affinity chromatography. I. Purification and properties of human intrinsic factor. J.Biol.Chem. 248, 3660-9.

Barker, H.A. 1972. Corrinoid-dependent enzymic reactions. Ann.Rev.Biochem. 41, 55-90.

Battersby, A.R. 1986. Biosynthesis of vitamin B12. Acc.Chem.Res. 19, 147-52.

Bertaux, O. and Valencia, R. 1972. Effets de la carence B12 sur les teneurs en proteines, ARN et ADN des cellules de Euglena gracilis Z en culture synchrone. J.Physiol. 65(3), 349-50.

Bertaux, O. and Valencia, R. 1973. Blocage de la division cellulaire et malformations induites par carence B12 chez des cellules synchrone de Euglena gracilis Z. C.R.Acad.Sci., Paris 276 Serie D, 753-6.

Bradbeer, C. 1971. Transport of vitamin B12 in Ochromonas malhamensis. Arch.Biochem.Biophys. 144, 184-92.

Bradbeer, C. 1979. Transport of vitamin B12 in Escherichia coli. In: Zagalak, B. and Friedrich, W. (eds.), Vitamin B12, pp 711-23. Walter de Gruyter, Berlin.

Bradbeer, C., Reynolds, P.R., Bauler, G.M. and Fernandez, M.T. 1986. A requirement for calcium in the transport of cobalamin across the outer membrane of Escherichia coli. J.Biol.Chem. 261(6), 2520-3.

- Bradford, M.M. 1976. A rapid and sensitive method for the quantitation of microgram quantities of protein utilizing the principle of protein-dye binding. *Anal.Biochem.* 72, 248-54.
- Bre, M.H., Diamond, J. and Jacques, R. 1975. Factors mediating the B12 requirement of Euglena. *J.Protozool.* 22(3), 432-4.
- Bre, M.H., Ferjhani, E.El. and Lefort-Tran, M. 1981. Sequential protein dependent steps in the cell cycle. Initiation and completion of division in vitamin B12 replenished Euglena gracilis. *Protoplasma* 108, 301-18.
- Bre, M.H. and Lefort-Tran, M. 1978. Induction et reversibilite des evenements cuticulaires par carence et realimentation en vitamin B12 chez Euglena gracilis. *J.Ultr.Res.* 64, 362-76.
- Bruno, S.F., Staker, R.D. and Curtis, L.L. 1981. Seasonal variation of vitamin B12, B12 analogs and phytoplankton in a Long Island New York U.S.A estuary. *J.Mar.Res.* 39 (2), 335-52.
- Bunt, J.S. 1970 Uptake of cobalt and vitamin B12 by tropical marine macroalgae. *J.Phycol.* 6, 339-43.
- Burkholder, P.R. and Burkholder, L.M. 1956. Vitamin B12 in the suspended solids and marsh muds collected along the coast of Georgia. *Limnol.Oceanog.* 1, 202-8.
- Burton, J.D. 1980. Factors limiting primary production: Nutrients. In: Raymont, J.E.G. (ed.) *Plankton and productivity in the oceans*, 2nd. Ed. pp 297-347, Pergamon Press, Oxford.

- Carell, E.F. 1969. Studies on the chloroplast development and replication in Euglena. I. Vitamin B12 and chloroplast replication. *J.Cell.Biol.* 41, 431-40.
- Carell, E.F., Johnston, P.L. and Christopher, A.R. 1970. Vitamin B12 and the macromolecular composition of Euglena. *J.Cell.Biol.* 47, 525-30.
- Carlucci, A.F. 1970. The ecology of the plankton off La Jolla, California in the period April through September, 1967. II. Vitamin B12, thiamine and biotin. *Bull.Scripps.Inst.Oceanog.* 17, 23-30.
- Carlucci, A.F. and Bowes, P.M. 1970a. Production of vitamin B12, thiamine and biotin by phytoplankton. *J.Phycol.* 6, 351-7.
- Carlucci, A.F. and Bowes, P.M. 1970b. Vitamin production and utilization by phytoplankton in mixed culture. *J.Phycol.* 6, 393-400.
- Carlucci, A.F. and Bowes, P.M. 1972. Vitamin B12, thiamine and biotin contents of marine phytoplankton. *J.Phycol.* 6, 351-7.
- Carlucci, A.F. and Silbernagel, S.B. 1966. Bioassay of seawater. II. Methods for the determination of concentrations of dissolved vitamin B1 in seawater. *Can.J.Microbiol.* 12, 1079-89.
- Carlucci, A.F. and Silbernagel, S.B. 1967. Bioassay of seawater. IV. The determination of dissolved biotin in seawater using C14 uptake by cells of Amphidinium carteri. *Can.J.Microbiol.* 13, 979-86.



- Carlucci, A.F., Silbernagel, S.B. and McNally, P.M. 1969. Influence of temperature and solar radiation on persistence of vitamin B12, thiamine and biotin in seawater. *J. Phycol.* 5, 302-5.
- Daisley, K.W. 1961. Gel filtration of seawater: separation of free and bound forms of vitamin B12. *Nature, London.* 191, 868-9.
- Daisley, K.W. 1969. Monthly survey of vitamin B12 concentrations in some waters of the English lake district. *Limnol. Oceanog.* 14, 224-8.
- Daisley, K.W. 1970. The occurrence and nature of Euglena gracilis proteins that bind vitamin B12. *Int. J. Biochem.* 1, 561-74.
- Daisley, K.W. and Fisher, L.R. 1958. Vertical distribution of vitamin B12 in the sea. *J. Mar. Biol. Ass. U.K.* 37, 683-6.
- Davies, A.G. and Leftley, J.W. 1985. Vitamin B12 binding by microalgal ectocrines: dissociation constant of the vitamin-binder complex determined using an ultrafiltration technique. *Mar. Ecol. Prog. Ser.* 21, 267-273.
- Dautry-Varsat, A. and Lodish, H.F. 1984. How receptors bring proteins and particles into cells. *Sci. Amer.* 250(5), 48-54.
- Dawson, R.M.C., Elliot, D.C., Elliot, W.H. and Jones, K.M. 1969. *Data for biochemical research.* 2nd Ed. University Press, Oxford.

- DeVeaux, L.C., Clevenson, D.S., Bradbeer, C. and Kadner, R.J. 1986. Identification of the BtuCED polypeptides and evidence for their role in vitamin B12 transport in Escherichia coli. J.Bacteriol. 167(3), 920-7.
- Dolphin, D., Banks, A.R., Cullen, W.R., Cutler, A.R. and Silverman, R.B. 1979. The mechanism of action of coenzyme B12. In: Zagalak, B. and Friedrich, W. (eds.), Vitamin B12, pp 575-86. Walter de Gruyter, Berlin.
- Droop, M.R. 1957. Vitamin B12 in marine ecology. Nature, Lond. 180, 1041-2.
- Droop, M.R. 1958. Requirement for thiamine among some marine and supralittoral protista. J.Mar.Biol.Ass.,U.K. 37, 323-9.
- Droop, M.R. 1961. Vitamin B12 and marine ecology : the response of Monochrysis lutheri. J.Mar.Biol.Ass.,U.K. 41, 69-76.
- Droop, M.R. 1962. Organic micronutrients. In: Lewin, R.A. (ed.). Physiology and biochemistry of algae, pp 141-54. Academic Press, London.
- Droop, M.R. 1968. Vitamin B12 and marine ecology IV. The kinetics of uptake, growth and inhibition in Monochrysis lutheri. J.Mar.Biol.Ass.U.K. 48, 689-733.
- Droop, M.R. 1974. The nutrient status of algal cells in continuous culture. J.Mar.Biol.Ass. U.K. 54, 825-55.
- Droop, M.R., McLaughlin, J.J.A., Pintner, I,J, and Provasoli, L. 1959. Specificity of some protophytes toward vitamin B12-like compounds. In: Int.Oceanog. Congress - Preprints A.A.A.S. 916-8.

- Droop, M.R. and Scott, J.M. 1978. Steady state energetics of a planktonic herbivore. J.Mar.Biol.Ass.U.K. 58, 749-72.
- Durr, M., Boller, T. and Wiemken, A. 1975. Polybase induced lysis of yeast spheroplasts. Arch.Microbiol. 105, 319-27.
- Easley, L.W. 1969. Modification of protein synthesis by vitamin B12 in the marine algal flagellate Neochloris pseudoalveolaris. J.Protozool. 16, 289-94.
- Eisenthal, R. and Cornish-Bowden, A. 1974. The direct linear plot. A new graphical procedure for estimating enzyme kinetic parameters. Biochem.J. 139, 715-20.
- Epstein, S.S., Causely, D. and Bush, P. 1962. Influence of vitamin B12 on the size and growth of Euglena gracilis. J.Protozool. 9(3), 336-9.
- Eyden, B.P. 1975. Light and electron microscope study of Dunaliella primolecta Butcher (Volvocida). J.Protozool. 22(3), 336-44.
- Fiala, M. and Oriol, L. 1984. Vitamine B12 et phytoplancton dans l'Ocean Antarctique. Distribution et approche experimental. Mar.Biol. 79, 325-32.
- Fogg, G.E. 1966. The extracellular products of algae. Oceanogr.Mar.Biol.Ann.Rev. 4, 195-212.
- Fogg, G.E. 1975. Primary productivity. In: Riley, J.P. and Skirrow, G. (eds.), Chemical oceanography Vol. 2 (2nd Ed.), pp 385-453. Academic press, London.

- Ford, J.E. 1958. B12-vitamins and the growth of Ochromonas malhamensis. J.Gen.Microbiol. 19, 161-72.
- Ford, J.E., Gregory, M.E. and Holdsworth, E.S. 1955. Uptake of B12-vitamins in Ochromonas malhamensis. "Biochem.J. 61, xxiii.
- Francis, G.L., Smith, G.W., Toskes, P.P. and Sanders, E.G. 1977. Purification of hog gastric intrinsic factor by a simple two-step procedure based on affinity chromatography and a selective guanidine hydrochloride gradient. Gastroenterology 72, 1304-7.
- Furuki, M. and Kubo, K. 1984. The interrelations among phytoplankton, bacteria and properties of seawater in the Sea of Harima. Hakkokogaku 62, 181-8.
- Furuki, M., Kubo, K., Moriguchi, Y. and Kitamara, H. 1984. Variations of vitamin B12 concentration in the Sea of Harima. Hakkokogaku 62, 171-9.
- Galli, R., Lucchini, G. and Bianchetti, R. 1985. Vitamin B12 requirement and propionate utilization in Euglena gracilis. Plant Sci. 38(3), 193-8.
- Gleason, F.K. and Hogenkamp, H.P.C. 1970. Ribonucleotide reductase from Euglena gracilis, a deoxyadenosyl cobalamin dependant enzyme. J.Biol.Chem. 245, 4894-9.
- Goldstein, J.I., Newbury, D.E., Echlin, P., Joy, D.C. Fiori, C. and Lifshin, E. 1981. Scanning electron microscopy and X-ray microanalysis. Plenum Press, New York.

Grasbeck, R. 1979. Soluble and membrane-bound vitamin B12 transport proteins. In: Zagalak, B. and Friedrich, W. (eds.), Vitamin B12, pp 743-63. Walter de Gruyter, Berlin.

Green, J.C. 1975. The fine structure and taxonomy of the Haptophycean flagellate Pavlova lutheri (Droop) comb. nov. (= Monochrysis lutheri Droop). J.Mar.Biol.Ass.U.K. 55, 785-93.

Green, J.C. 1980. The fine structure of Pavlova pinguis (Green) and a preliminary survey of the order Pavlovales (Prymnesiophyceae). Br.Phycol.J. 15, 151-91.

Guillard, R.R.L. 1968. B12 specificity of marine centric diatoms. J.Phycol. 4, 59-64.

Haines, K.C. and Guillard, R.R.L. 1974. Growth of vitamin B12-requiring marine diatoms in mixed laboratory cultures with vitamin B12 producing marine bacteria. J.Phycol. 10, 245-52.

Hellebust, J.A. 1974. Extracellular products. In: Stewart, W.D.P. (ed.), Algal physiology and biochemistry, pp 838-54. Blackwell Scientific Publications, Oxford.

Helman, E.Z. and Ting, P. 1973. Counting of beta and gamma emitters used in clinical radioimmunoassays and competitive binding assays by liquid scintillation counters. Clin.Chem. 19(2), 191-6.

Herdman, M., and Carr, N.G. 1972. The isolation and characterisation of mutant strains of the blue green alga, Anacystis nidulans. J.Gen.Microbiol. 70, 213-20.

- Herold, L.D. and Sullivan, C.W. 1980. Cellular characteristics of vitamin B12 uptake in a marine auxotrophic diatom. *J. Phycol.* 16(Suppl.), p19.
- Hippe, E. and Olesen, H. 1971. Nature of vitamin B12 binding. III. Thermodynamics of binding to human intrinsic factor and transcobalalmins. *Biochim. Biophys. Acta* 243, 83-9.
- Hoshaw, R.W. and Maluf, L.Y. 1981. Ultrastructure of the green flagellate Dunaliella tertiolecta (Chlorophyceae, Volvocales) with comparative notes on three other species. *Phycologia* 20(2), 199-206.
- Hutner, S.H., Bach, M.K., and Ross, G.M.I. 1956. A sugar containing basal medium for vitamin B12 assay with Euglena: application to body fluids. *J. Protozool.* 3, 101-12.
- Hutner, S.H., Provasoli, L., Stokstad, E.L.R., Hoffman, C.E., Belt, M., Franklin, A.L. and Jukes, T.H. 1949. Assay of antipernicious anemia factor with Euglena. *Soc. Exp. Biol. Med.* 70, 118-20.
- Inskeep, W.P. and Bloom, P.R. 1985. Extinction coefficients of chlorophyll a and b in N,N-dimethylformamide and 80% acetone. *Plant Physiol.* 77, 483-5.
- Isegawa, Y., Nakano, Y. and Kitaoka, S. 1984. Conversion and distribution of cobalamin in Euglena gracilis Z with special reference to its location and probable function within chloroplasts. *Plant Physiol.* 76, 814-8.

- Jacobsen, D.W., Montejano, Y.D., and Huennekens, F.M. 1981. Rapid purification of cobalamin-binding proteins using immobilized aminopropylcobalamin. *Anal.Biochem.* 113, 164-71.
- Jaenicke, L. 1964. Vitamin and coenzyme function: vitamin B12 and folic acid. *Ann.Rev.Biochem.* 33, 287-312.
- Kanazawa, A. 1963. Vitamins in algae. *Bull.Jap.Soc.Sci.Fish.* 29, 713-31.
- Kim, J.M., Park, C.U., Jeon, U.S. and Kong, S.C. 1986. Biochemical study on the environmental preservation of a lake - distribution of chemical compounds and vitamin B12 of Okjeong lake. *Bull.Korean Fish.Soc.* 19(1), 67-71.
- Klut, M.E., Bisalputra, T. and Antia, N.J. 1983. Agglutination of the Chlorophycean flagellate Dunaliella tertiolecta by treatment with lectins or divalent cations at alkaline pH. *J.Phycol.* 19, 112-5.
- Kristensen, H.P.O. 1955. Investigations into the Euglena gracilis method for quantitative assay of vitamin B12. *Acta Physiol.Scand.* 33, 232-7.
- Kristensen, H.P.O. 1956. A vitamin B12 binding factor formed in the cultures of Euglena gracilis var. bacillaris. *Acta Physiol.Scand.* 37, 8-13.
- Kombrink, E. and Wober, G. 1980. Preparation of intact chloroplasts by chemically induced lysis of the green alga Dunaliella marina. *Planta* 149, 123-9.
- Lewin, J.C., and Lewin, R.A. 1960. Auxotrophy in marine littoral diatoms. *Can.J.Microbiol.* 6, 127-34.

- Lwoff, A., and Dusi, H. 1937. La pyridine et la thiazole, facteurs de croissance pour le flagelle Polytomella coeca. C.R.Acad.Sci., Paris 205, 630.
- Marcoulis, G. and Rothenberg, S.P. 1984. Isolation and characterization of two species of receptor which bind intrinsic factor. Arch.Biochem.Biophys. 235(2), 489-92.
- Menzel, D.W. and Spaeth, J.P. 1962. Occurrence of vitamin B12 in the Sargasso sea. Limnol.Oceanog. 7, 151-4.
- Messina, D.S. and Baker, A.L. 1982. Interspecific growth regulation in species succession through vitamin B12 competitive inhibition. J.Plankton.Res. 4(1), 41-6.
- Ohwada, K. and Taga, N. 1972. Vitamin B12, thiamine and biotin levels in Lake Sagami. Limnol.Oceanog. 17, 315-20.
- Oliveira, L., Bisalputra, T. and Antia, N.J. 1980. Ultrastructural observation of the surface coat of Dunaliella tertiolecta from staining with cationic dyes and enzyme treatments. New Phytol. 85, 385-92.
- Pintner, I.J. and Altmeyer, V.L. 1979. Vitamin B12 binder and other algal inhibitors. J.Phycol. 15, 391-98.
- Provasoli, L. 1958. Nutrition and ecology of Protozoa and algae. Ann.Rev.Microbiol. 12, 279-308.
- Provasoli, L. 1963. Organic regulation of phytoplankton fertility. In: Hill, M.N. (ed.), The Sea. Vol. 2, pp 165-219. Interscience, New York.



Provasoli, L. 1971. Nutritional relationships of marine organisms. In: Costlow, J.D. (Ed.) Fertility of the sea. pp 369-82. Gordon and Breach, New York.

Provasoli, L. and Carlucci, A.F. 1974. Vitamins and growth regulators. In: Stewart, W.D.P. (ed.), Algal physiology and biochemistry, pp 741-87. Blackwell Scientific Publications, Oxford.

Provasoli, L., McLaughlin, J.J.A. and Droop, M.R. 1957. The development of artificial media for marine algae. Arch.Microbiol. 25, 392-428.

Read, S.M. and Northcote, D.H. 1981. Minimization of variation in the response to different proteins of the coomassie blue G dye binding assay. Anal.Biochem. 116, 53-64.

Reeves, R.B. and Fay, F.S. 1966. Cyanocobalamin (vitamin B12) uptake by Ochromonas malhamensis. Amer.J.Physiol. 210(6), 1273-8.

Robbs, P.G., Rosenberg, J.A., and Costa, F.A. 1983. Conteudo vitaminico de Scenedesmus quadricauda. II. Vitamina B12. Rev.Lat-amer.Microbiol. 25, 275-80.

Ryther, J.G., and Guillard, R.R.L. 1962. Studies of marine phytoplankton diatoms. II. Use of Cyclotella nana Hustedt for assays of vitamin B12 in seawater. Can.J.Microbiol. 8, 437-45.

Sarhan, F., Houde, M. and Cheneval, J.P. 1980. The role of vitamin B12 binding in the uptake of the vitamin by Euglena gracilis. J.Protozool. 27(2), 235-8.

Sebrell, W.H.(Jr.) and Harris, R.S. 1968. The vitamins, Vol.2 (2nd Ed.). Academic Press, New York.

Seligman, P.A. and Allen, R.H. 1978. Characterization of the receptor for transcobalamin II isolated from human placenta. J.Biol.Chem. 253(6), 1766-72.

Smith, E.L. 1965. Vitamin B12 (3rd Ed.). Methuen, London.

Stadtman, T.C. 1971. Vitamin B12. Science 171, 859-67.

Swift, D.G. 1980. Vitamins and phytoplankton growth. In: Morris, I. (ed.) The physiological ecology of phytoplankton. pp 329-68.

Swift, D.G. 1981. Vitamin levels in the Gulf of Maine and the ecological significance of vitamin B12 there. J.Mar.Res. 39(2), 375-403.

Swift, D.G. and Guillard, R.R.L. 1978. Unexpected response to vitamin B12 of dominant centric diatoms from the spring bloom in the Gulf of Maine. J.Phycol. 14, 377-86.

Swift, D.G. and Taylor, W.R. 1974. Growth of vitamin B12-limited cultures: Thalassiosira pseudonana, Monochrysis lutheri and Isochrysis galbana. J.Phycol. 10, 385-91.

Van Kley, H. and Hale, S.M. 1977. Assay for protein by dye binding. Anal.Biochem. 81, 485-7.

Varma, T.N.S., Abraham, A. and Hansen, I.A. 1961. Accumulation of 58Co-vitamin B12 by Euglena gracilis. J.Protozool. 8(2), 212-6.

Veer, J. Van Der. 1979. Pavlova and the taxonomy of flagellates especially the Chrysomonads. Thesis, Rijks-universiteit, Groningen.

Vladimirova, M.G., Markelova, A.G. and Semenenko, V.E. 1982. Use of the cytoimmunofluorescent method to clarify localization of ribulose biphosphate carboxylase in pyrenoids of unicellular algae. *Fiziologia Rastenii*, 29(5), 941-50.

Wagner, F. 1966. Vitamin B12 and related compounds. *Ann.Rev.Biochem.* 35, 405-34.

Wetzel, R.G. 1965. Nutritional aspects of algal productivity in marl lakes with particular reference to enrichment bioassays and their interpretation. *Mem. 1st.Ital.Idrobiol.* 18(suppl.), 137-57.

Wetzel, R.G. 1966. Productivity and nutrient relationships in marl lakes of northern Indiana. *Verh.Int.Ver.Limnol.* 16, 321-32.

White, W.S. and Wetzel, R.G. 1985. Association of vitamin B12 with calcium carbonate in hardwater lakes. *Arch.Hydrobiol.* 104(3), 305-9.

Yamochi, S. 1984. Nutrient factors involved in controlling the growth of the red tide flagellates Prorocentrum micans, Eutreptiella sp. and Chattonella marina in Osaka Bay. *Bull.Plankton Soc.Japan.* 31(2), 97-106.